

FLOS

COLLECTION CATALOGUE 2024

FRANÇAIS / ENGLISH

FEATURED PRODUCTS	SOPHISTICATED COMMODITIES	SOFT ARCHITECTURE
14 • MY CIRCUIT	568 LED CURTAIN	598 WALL RUPTURE
38 BELT	570 IN-FINITY	600 SOFTPROFILE
60 INFRA-STRUCTURE	574 CIRCLE OF LIGHT	602 JUNCOS
80 INFRA-STRUCTURE	575 LIGHT CUT MINI	604 SOFT SPUN
EPISODE 2	576 SUPER FLAT	606 ABAJOURD'HUI
100 GUSTAVE	578 LIGHT BELL	608 USO
118 • EMI	580 THIN LED	610 USO COVE LIGHTING
148 OBLIQUE	582 LIGHT SUPPLY	612 G-O IN
170 DIVERSION	584 JOHNNY	614 TEARDROP
194 ZERO TRACK &	588 WAN	616 ROUND, SQUARE &
• ZERO TRACK PRO	590 G-O	VERTICAL LIGHT
222 THE MICRO RUNNING	590 THEBLOCKOFLIGHT	
MAGNET		
248 • THE RUNNING MAGNET		
278 THE TRACKING MAGNET		
304 THE TRACKING POWER		
322 THE FAST TRACK		
336 • WORKMATES		
362 LIGHT SHADOW		
384 • LIGHT SHADOW		
DOTS & PRO		
408 ECLECTIC		
422 • LIGHT SHADOW SPOT		
436 CAMERA		
452 SUPER LINE &		
SUPERLINE PRO		
470 KAP		
504 C1		
518 FIND ME		
532 UT		
550 BON JOUR		
558 FORT KNOX		

- Nouveau produit/New product

L'objectif de Flos est de toujours offrir la meilleure technologie fiable disponible. Pour cela, nous contrôlons constamment nos produits et nous les améliorons dès que les évolutions technologiques offrent des avantages à nos partenaires et clients. Notre site web flos.com est mis à jour quotidiennement et vous y trouverez les informations les plus récentes et les détails techniques dont vous avez besoin concernant vos produits.

Flos aim is to offer always the best reliable technology available, constantly reviewing our products and upgrading them as soon as technologic evolutions offers benefits for our partners and clients. Thus, when you need technical details and the most recent product information, please browse the product section of our daily updated website flos.com.



MY CIRCUIT
14



OBLIQUE
OBLIQUE FLOOR
148

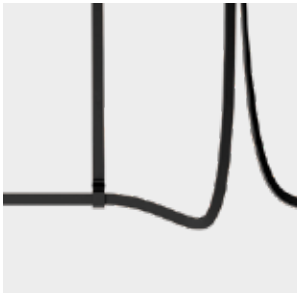

BELT
38

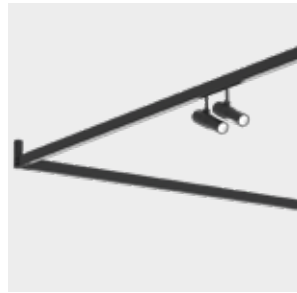

DIVERSION
170

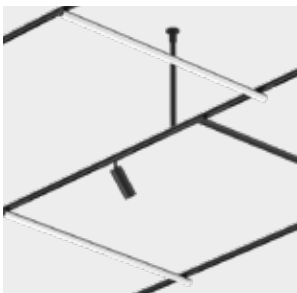

INFRA-STRUCTURE
60

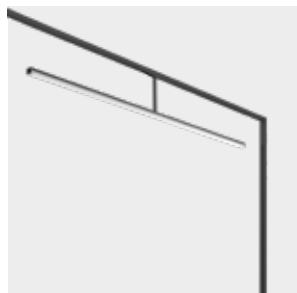

ZERO TRACK
ZERO TRACK PRO
194



INFRA-STRUCTURE
Episode 2
80



THE MICRO RUNNING
MAGNET
222



GUSTAVE
100



THE RUNNING MAGNET
248



EMI
118



THE TRACKING MAGNET
278



THE TRACKING POWER
304



LIGHT SHADOW SPOT
422



THE FAST TRACK
322

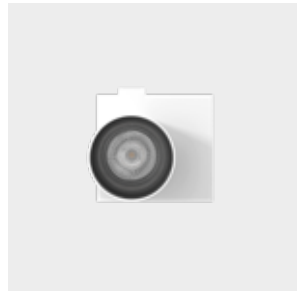

CAMERA
436



WORKMATES
336

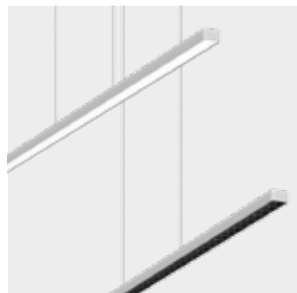

SUPER LINE
SUPER LINE PRO
452



LIGHT SHADOW
362



KAP
EASY KAP
KAP SURFACE
KAP SUSPENSION
470



LIGHT SHADOW PRO
LIGHT SHADOW DOTS
384

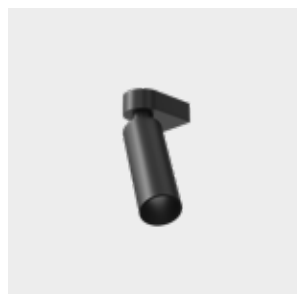

C1
504



ECLECTIC
408

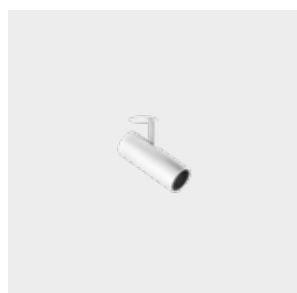

FIND ME
518



UT SPOT
UT DOWNLIGHT
UT PRO SURFACE
532



LIGHT CUT MINI
575

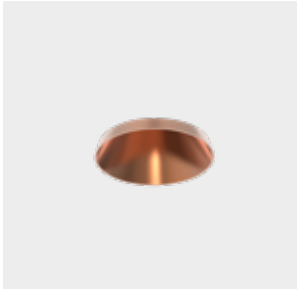

BON JOUR
550



SUPER FLAT
576



FORT KNOX WALL
FORT KNOX WALL MINI
558

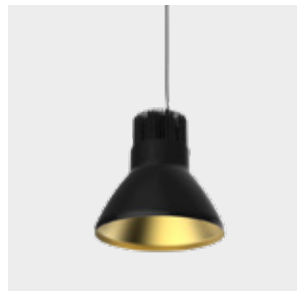

LIGHT BELL
578



LED CURTAIN
568



THIN LED
580



IN-FINITY
570



LIGHT SUPPLY
582



CIRCLE OF LIGHT
574



JOHNNY
584

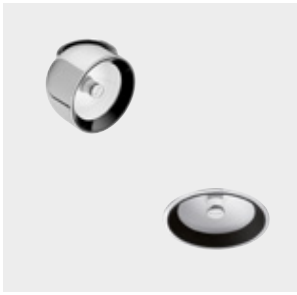

WAN SPOT
WAN DOWNLIGHT
588



SOFT SPUN
604

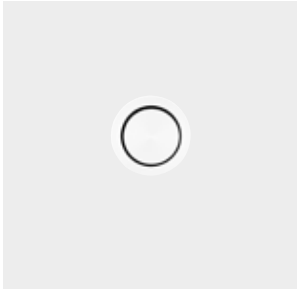

G-O
590



ABAJOURD'HUI
606

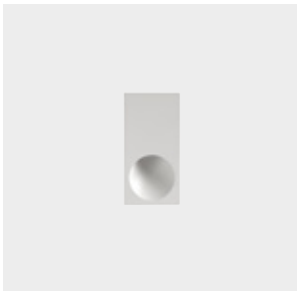

THEBLOCKOFLIGHT
590



USO
608



WALL RUPTURE
598

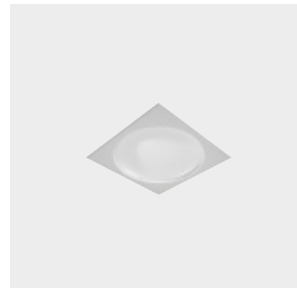

USO COVE LIGHTING
610



SOFTPROFILE
600



G-O IN
612



JUNCOS
602

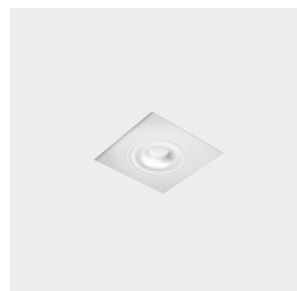

TEARDROP
614



ROUND, SQUARE &
VERTICAL LIGHT
616

My Circuit, Belt, Infra-Structure, Infra-Structure
Episode 2, Gustave, EMI, Oblique, Diversion,
Zero Track, Zero Track Pro, The Micro Running
Magnet, The Running Magnet, The Tracking
Magnet, The Tracking Power, The Fast Track,
Workmates, Light Shadow, Light Shadow Dots,
Light Shadow Pro, Eclectic, Light Shadow Spot,
Camera, Super Line, Super Line Pro, Kap, C1,
Find Me, UT, Bon Jour, Fort Knox Wall.

FEATURED PRODUCTS

My Circuit, conçu par Michael Anastassiades, est la première structure pour l'éclairage d'intérieur constituée d'un profilé flexible qui permet de tracer au plafond des parcours continus et totalement libres, combinant des formes rectilignes avec des courbes de différents rayons.

My Circuit, designed by Michael Anastassiades, is the first structure for indoor lighting consisting of a flexible profile that allows the drawing of continuous and completely free paths on the ceiling, combining linear sections with curves of various radii.

MY CIRCUIT

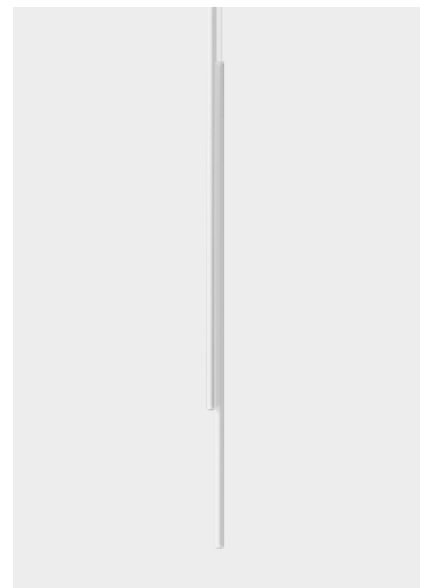
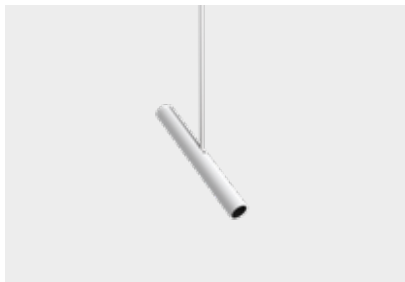
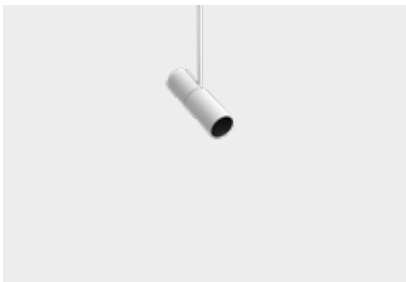

Pour dessiner un tracé, les modules de fixation qui seront reliés entre eux doivent être sélectionnés et combinés consécutivement jusqu'à ce qu'une colonne centrale soit dessinée, fixée au plafond et définisse la forme de MyCircuit. Une fois le tracé terminé -et installé au plafond-, vous obtiendrez la longueur totale de la colonne centrale. Le profilé flexible sera installé dessus. Les accessoires et les luminaires seront installés en dernier.

When designing a layout, the fixing modules to be joined together must be chosen and combined consecutively until a central spine is drawn up that is mounted on the ceiling and defines the shape of My Circuit.

Once this layout is completed and installed on the ceiling, you obtain the total length of the central spine. The flexible profile is then installed onto this. Finally come the accessories and luminaires.

- 1 POWER SUPPLY END
- 2 FIXATION STRAIGHT
- 3 FIXATION CURVES
- 4 MY CIRCUIT PROFILE
- 5 POWER SUPPLY MIDDLE
- 6 MIDDLE CAP
- 7 SPOTS
- 8 SUSPENSION FIXTURES
- 9 END CAP

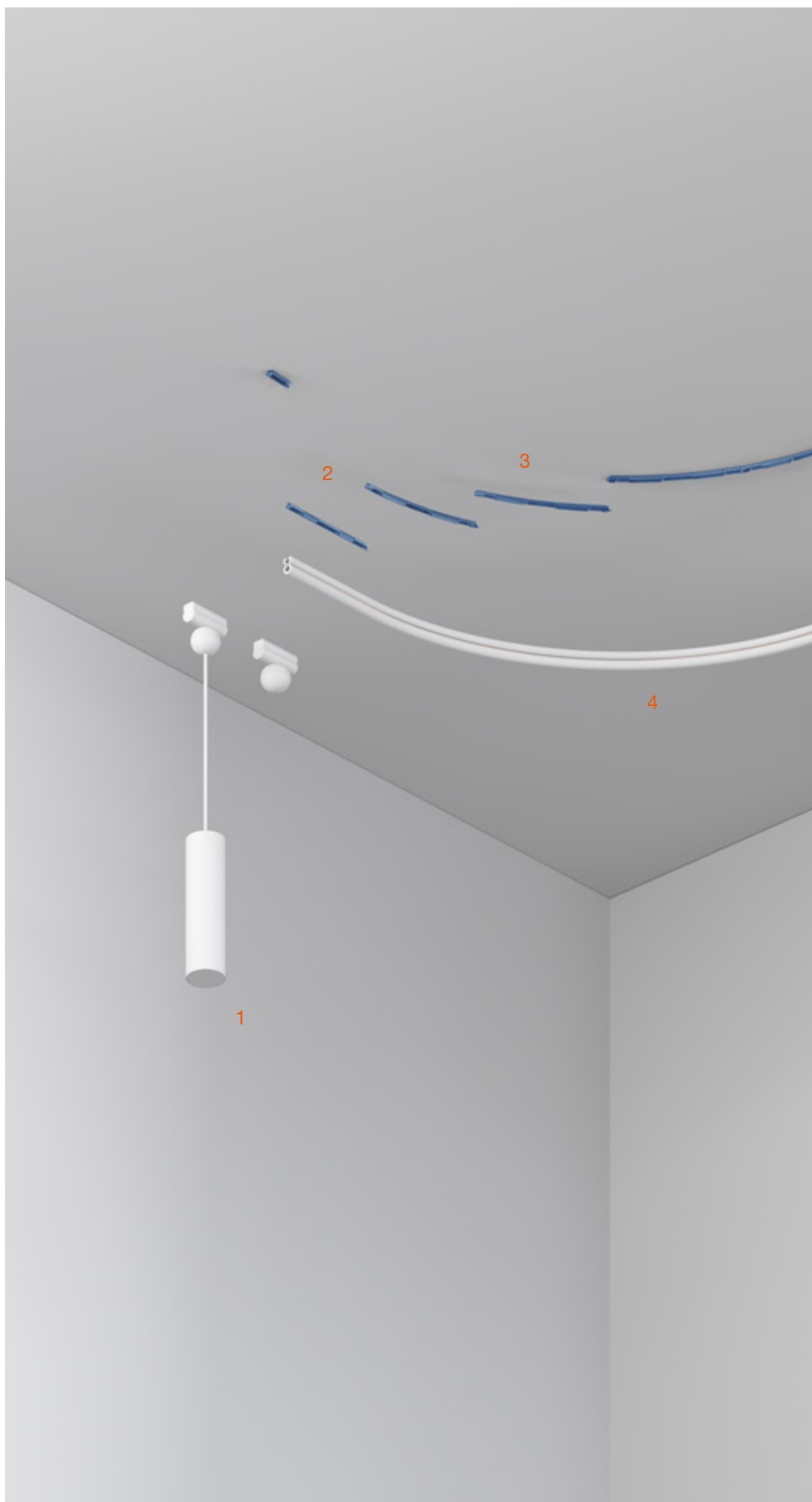

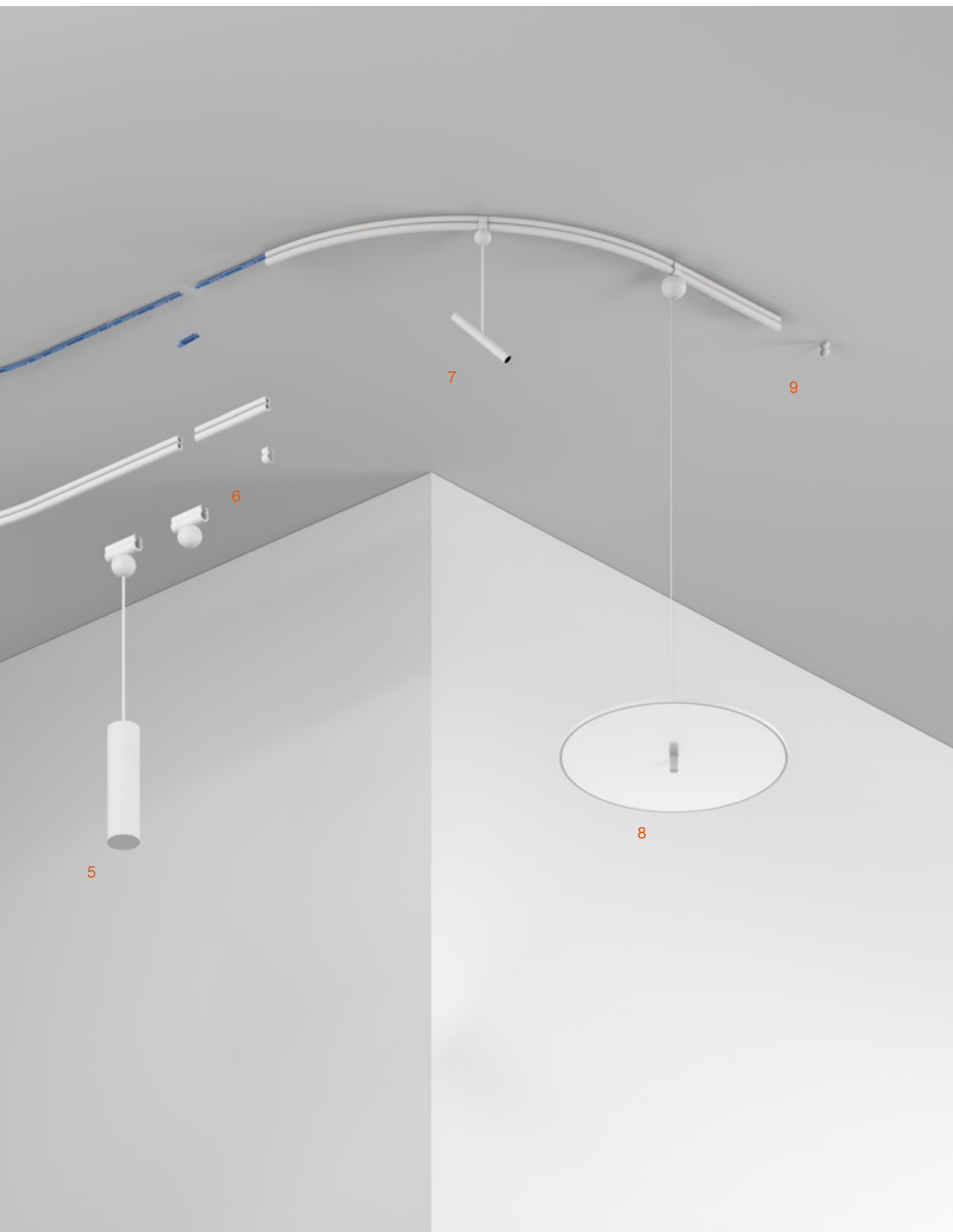

My Circuit propose une approche fonctionnelle de l'éclairage décoratif. Système d'éclairage au plafond flexible, My Circuit s'inspire des petites voitures électriques de l'enfance d'Anastassiades, dont les éléments sont utilisés pour recréer dans une vision contemporaine et minimaliste les motifs en plâtre que l'on retrouve sur le plafond des maisons anciennes.

My Circuit offers a functional approach to decorative lighting. A flexible ceiling system, My Circuit is inspired by electric slot cars from Anastassiades' childhood, whose elements are used to redesign a contemporary, minimalist take on plaster motifs found on the ceiling of period homes.









SPOTS

My Circuit propose deux familles de projecteurs : les élégants My Spots, conçus par Michael Anastassiades, et les My Light Shadow Spot, avec les caractéristiques techniques bien connues de la famille de produits Light Shadow.

My Circuit comes with two projector families: the elegant My Spots, designed by Michael Anastassiades, and the My Light Shadow Spots, with the well-known technical features of the Light Shadow family of products..

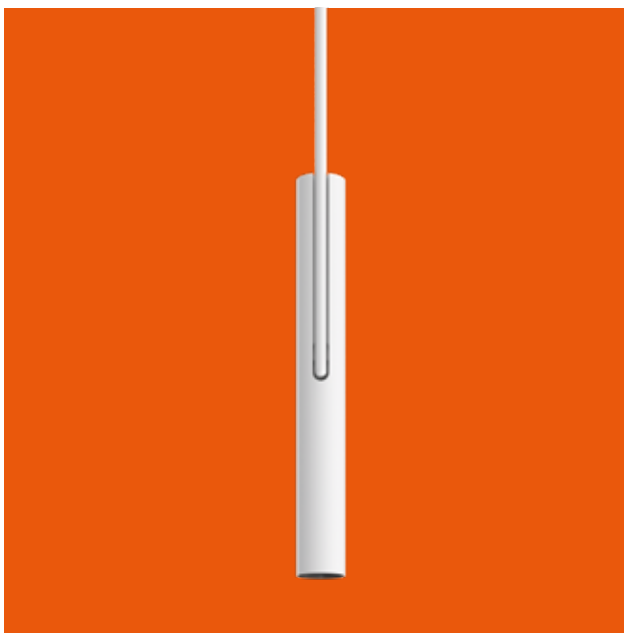

MY DISC & MY LINES

My Disc est un luminaire mince à émission Down pour downlight et éclairage ambiant. My Lines permet de suspendre un luminaire de My Circuit qui - fonctionnellement - agit dans l'espace comme un lampadaire.

My Disc is a slim Down emission luminaire for downlight and ambient illumination.

My Lines allows you to suspend a luminaire from My Circuit, which in functional terms acts as a floor lamp in the space.

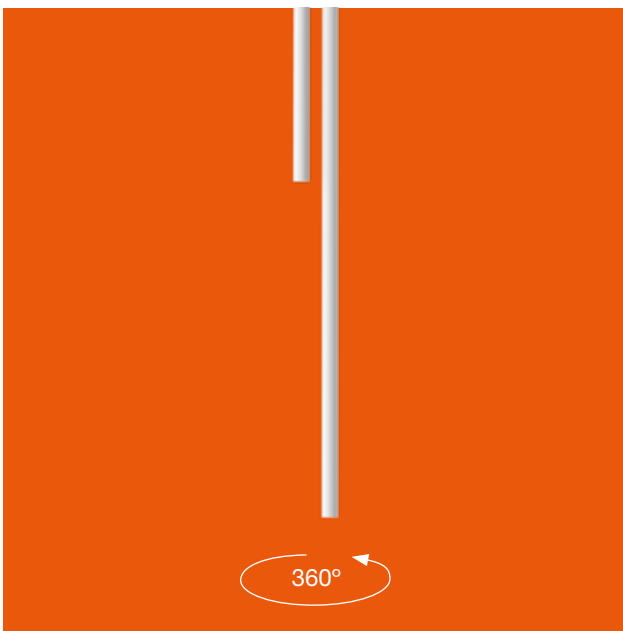

MY DOME & MY SPHERE

My Dome propose la pièce de suspension classique pour éclairage downlight réinterprétée à partir de la vision poétique de Michael Anastassiades. My Sphere est la solution My Circuit avec une présence esthétique qui se distingue par sa forme et son émission lumineuse omnidirectionnelle.

My Dome offers the classic suspension piece for downlight illumination reinterpreted with the poetry of Michael Anastassiades.

My Sphere is the My Circuit solution with an aesthetic presence characterised by its form and omnidirectional light emission.









Les fixations My Circuit sont concaténées comme des sections d'un circuit de petites voitures électriques. Avec l'union des sections nécessaires, la piste conçue est dessinée.

Le rail flexible innovant My Circuit est inséré dans les fixations comme une colonne vertébrale centrale. Une sorte d'« âme » intérieure qui donnera au profilé modelable sa forme définitive.

My Circuit fixations are concatenated like track sections on a Scalextric racing car set. The union of the necessary sections draws the designed route.

The innovative My Circuit flexible track is inserted into the fixations like a central spine. A sort of internal 'soul' that gives the modellable profile its final form.



Les luminaires My Circuit disposent d'adaptateurs spécialement conçus pour être reliés au rail flexible en l'embrassant de l'extérieur.

My Circuit luminaires have adapters specially designed to link with the flexible track by grasping it from the outside.

FLEXIBLE PROFILE



L: 8000 / 15000 / 20000









La piste de Michael Anastassiades est flexible et propose une nouvelle approche révolutionnaire pour éclairer un espace, un outil architectural qui joue sur un éclairage ambiant diffus et un éclairage d'accentuation sophistiqué.

Michael Anastassiades' revolutionary flexible track offers a new approach to illuminating a space, serving as an architectural tool that offers a combination of diffused ambient lighting and sophisticated accent lighting.

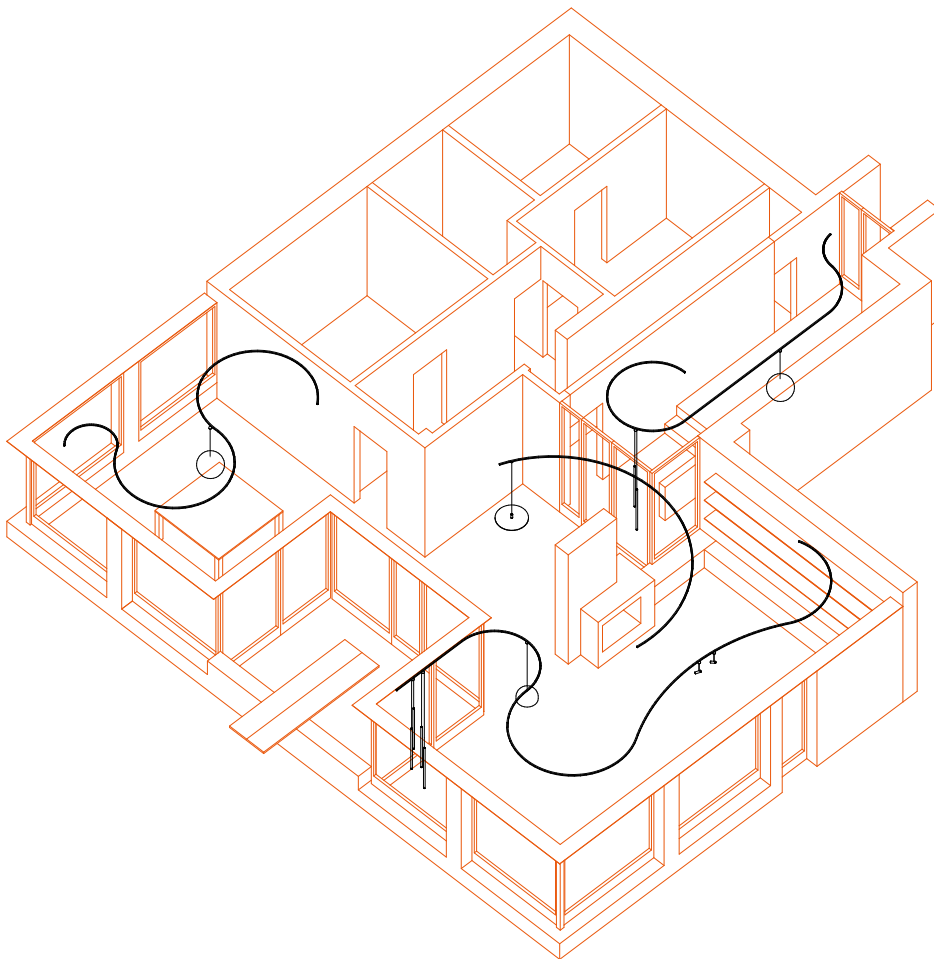

UNE MULTITUDE D'INSTALLATIONS

La piste sinueuse au plafond permet de réaliser de nombreuses options d'éclairage avec notamment des projecteurs haute performance et décoratifs, des lampes pendantes en forme de dômes ou de disques circulaires, et des lampes suspendues du sol au plafond, toutes définies selon l'approche poétique d'Anastassiades.

Les possibilités d'éclairage de My Circuit sont infinies, grâce à l'approche ludique de la modularité de sa piste et à ses innombrables objets d'éclairage qui peuvent être imposants et décoratifs ou à l'inverse fonctionnels et discrets. L'extrême simplicité des éléments et la polyvalence avec laquelle ils peuvent être combinés permettent de libérer la créativité du projet, en réalisant d'innombrables combinaisons.

ENDLESS LAYOUTS

Connecting to the sinuous ceiling track is a series of illuminating options that include high performance and decorative spotlights, pendants shaped like circular domes or discs, and suspended floor to ceiling lamps, all defined by Anastassiades' poetic approach to form.

There is seemingly no end to what My Circuit can achieve, thanks to the playful approach to modularity of its track and its rich portfolio of lighting objects that can enhance its presence or leave it as a functional, discreet tool.

The extreme simplicity of the elements and the versatility with which they can be combined allows you to unleash the creativity of a project in countless combinations.

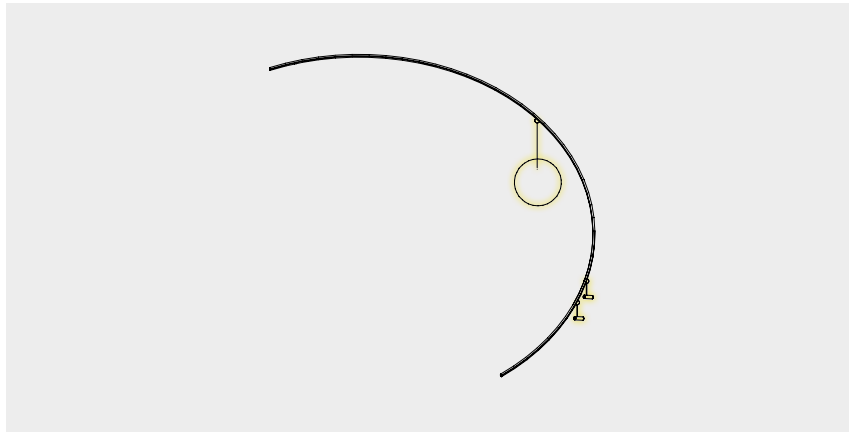
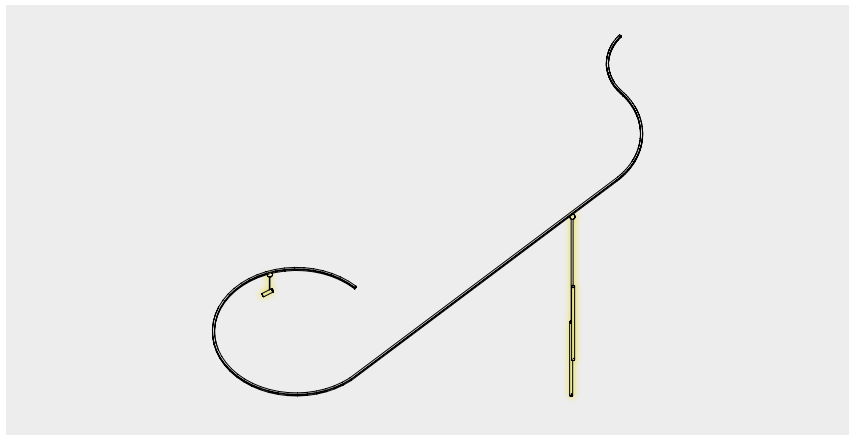
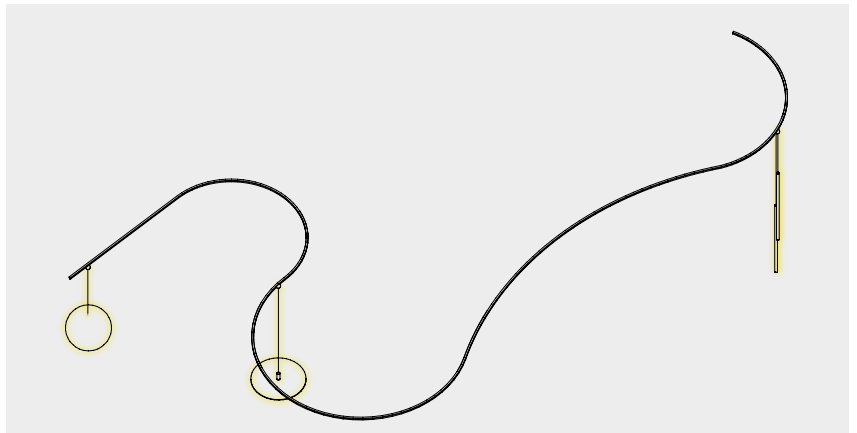
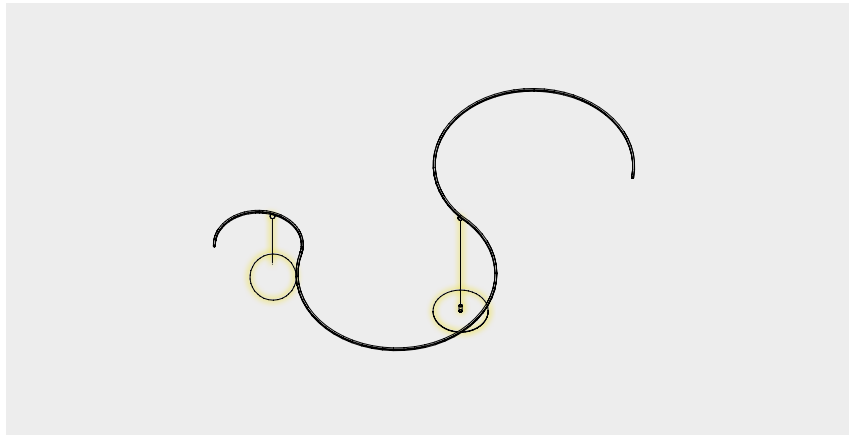



CASAMBI

Disponible avec contrôle individuel de chaque luminaire avec une application sur tablet ou smartphone (FLOS Control®).

Individual control of each luminaire directly through a tablet or smartphone application (FLOS Control®).

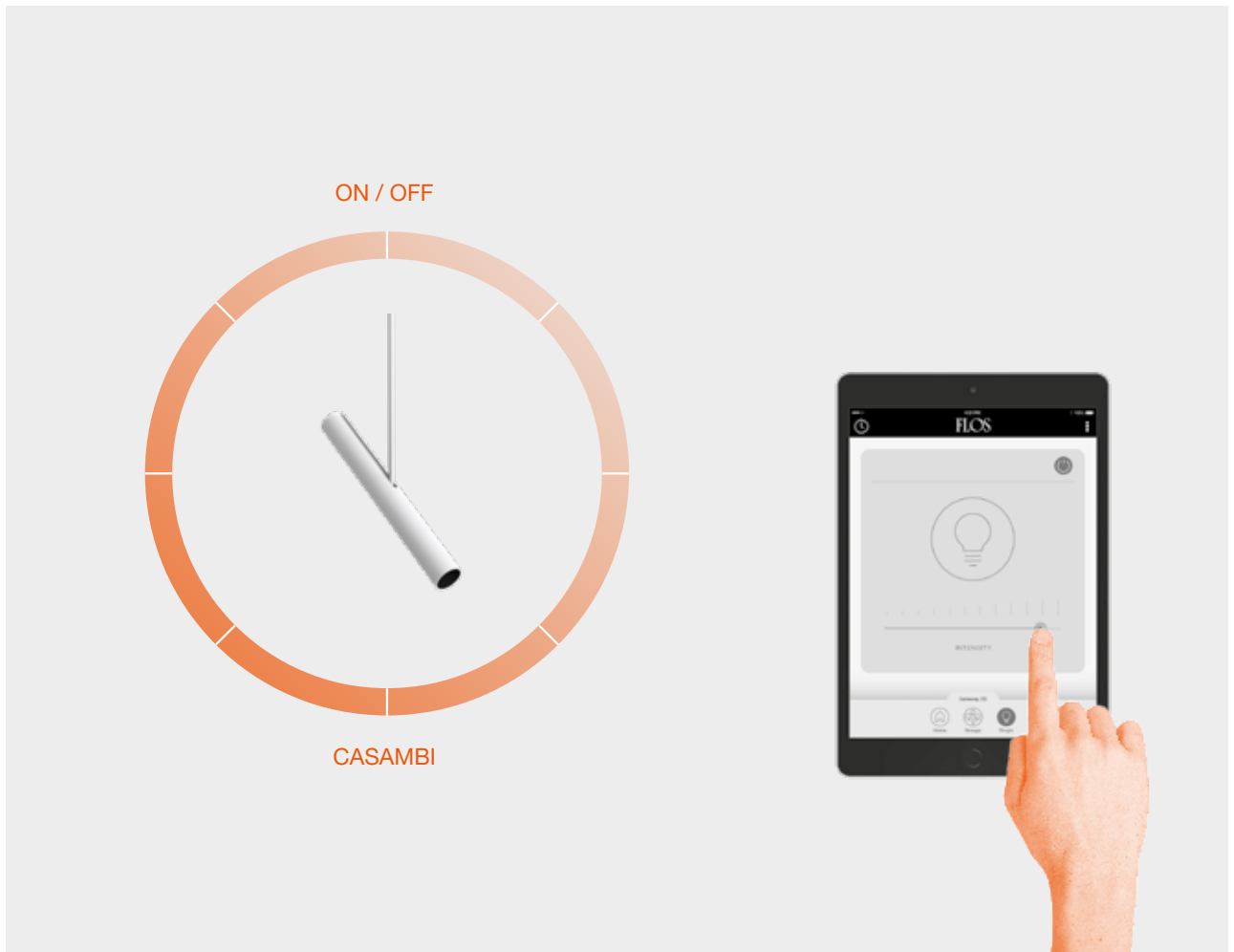

FLOS CONTROL®
BY CASAMBI

L'application FLOS Control® permet de contrôler les appareils d'éclairage du système par groupe, en contrôlant les scènes et la programmation.

Il suffit d'une installation électrique traditionnelle et du Gateway connecté par Bluetooth pour obtenir un contrôle total de l'espace.

Disponible pour IOS et Android

The FLOS Control® application allows you to control the system's luminaires as a group, controlling scenes and programming.

With a traditional electrical installation and the Gateway connected by Bluetooth, you obtain total control of the ambience.

Available for iOS and Android

MY CIRCUIT PROFILE

C5 Blanc
 C5 White

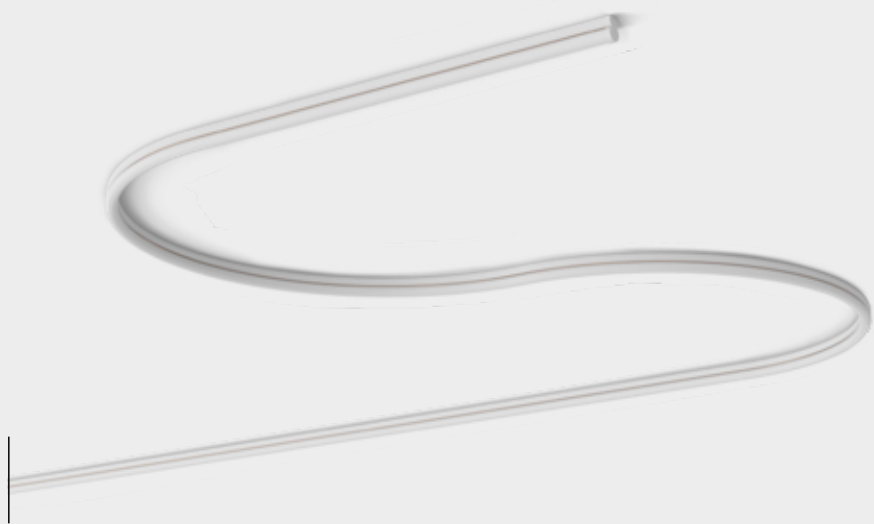

MY CIRCUIT PROFILE LIGHT MODULES

MY CIRCUIT
LIGHT SHADOW
SPOT Ø30



POWER LED
4W

MY CIRCUIT
LIGHT SHADOW
SPOT Ø45



LED ARRAY
8W

MY CIRCUIT
SPOT Ø25



POWER LED
4W

MY CIRCUIT
SPOT Ø35



LED ARRAY
8W

MY CIRCUIT PROFILE LIGHT MODULES

MY CIRCUIT
DOME



TOP LED
40W

MY CIRCUIT
SPHERE



TOP LED
40W

MY CIRCUIT
DISC

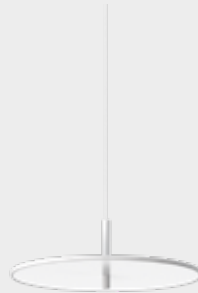

TOP LED
42W

MY CIRCUIT
LINES



TOP LED
2 x 23W



Spot



Medium



Flood



Wide Flood



Diffused

B

B

E

E

L

L

T

Ligne technique d'éclairage revêtue d'une fine couche en tissu (cuir naturel ou textile), cousue sur mesure pour y intégrer chaque élément de la composition. Le système de connexion innovant a été développé pour obtenir une ligne sinueuse sans interruptions apparentes.

Technical lighting line covered in a sewn to measure, fine leather or textile fabric cover that integrates all elements of the composition. The innovative connection system has been developed to achieve a sinuous line without apparent interruptions.

BELT

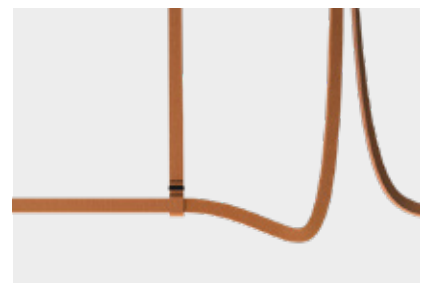
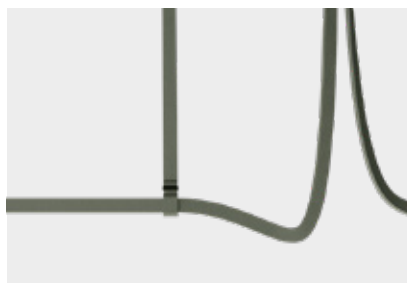
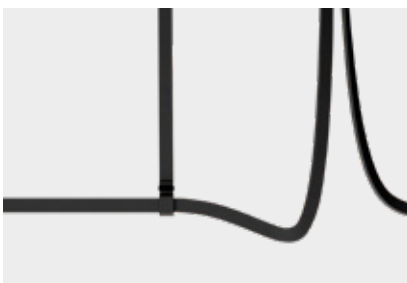
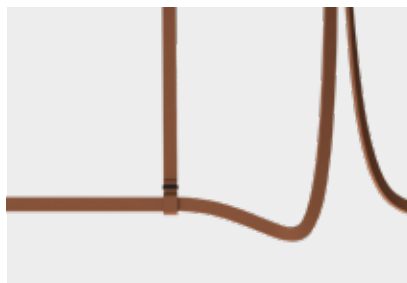
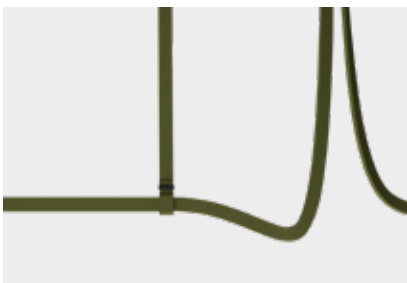





Le tissu, en cuir ou textile, représente le cœur du projet. Un matériau doux et chaud qui garantit la liberté dans l'espace mais qui se caractérise en même temps par une certaine rigidité qui crée une harmonie dans le résultat de la composition finale. Belt est revêtu d'un cuir fin, traité avec des teintures naturelles pour obtenir les trois finitions disponibles dans la gamme : cuir noir, vert et cuir naturel. Belt Fabric est revêtu d'un tissu technique particulier proposé en deux finitions décoratives avec une texture tissée : grey olive et copper brown.

The leather or textile fabric is the heart of the project. A soft and warm material that guarantees freedom in the space but, at the same time, is characterized by certain rigidity. The result is a harmonious final composition. Belt is covered in fine leather, treated with natural dyes to obtain the three finishes available in the range: black, green and natural leather. Belt Fabric is covered in a special technical fabric offering two decorative finishes with a knitted texture: grey olive and copper brown.

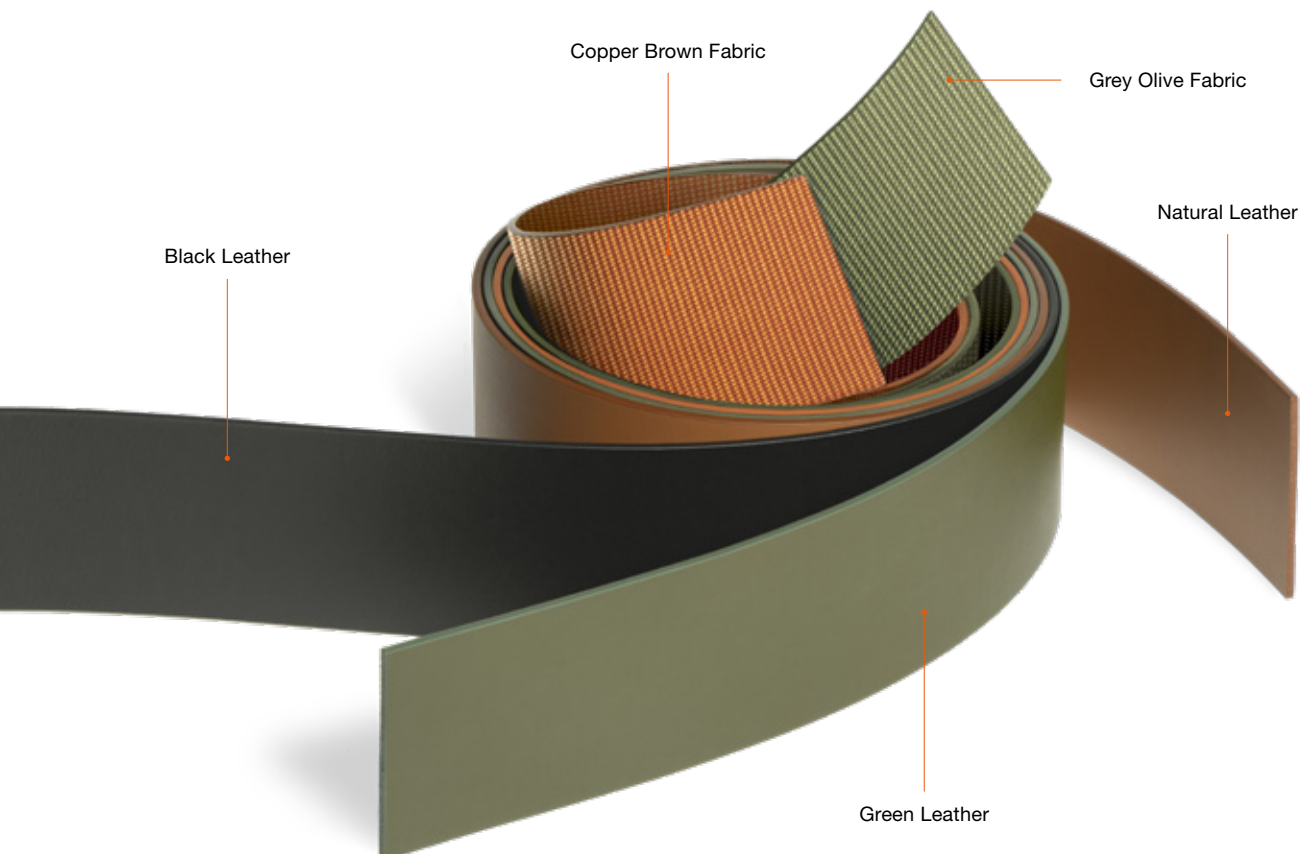



Belt, c'est de la pure flexibilité, une ligne sinueuse dont la nature est en équilibre entre la douceur du cuir ou du tissu et la rigidité de l'aluminium. L'élément mou est représenté par la connexion au réseau électrique, tandis que les parties rigides correspondent aux sources de lumière :
de longues lignes d'éclairage.

Belt is pure flexibility, a sinuous line whose nature is in balance between the softness of the leather or the fabric and the rigidity of aluminium. The soft element is represented by the connection to the electrical grid, while the rigid parts correspond to the light sources, which are long lighting lines.

- 1 CEILING FEEDING BASE
- 2 ELECTRICAL LOOP CONNECTOR
- 3 CEILING MOUNTING
- 4 SUSPENSION BELTS
- 5 LIGHT PROFILE







Chaque élément du produit est contrôlé par des lanières en tissu (cuir ou textile). Certaines supportent le poids de l'appareil, d'autres transportent de l'électricité et certaines contiennent de la lumière. La section initiale de chaque composition descend du plafond ou se lève à partir du mur, voire même du sol, et est ensuite suspendue par des sangles prévues à cet effet.

Each element of the product is controlled by leather or textile fabric straps. Some of them support the weight of the device, some carry electricity and some contain light. The initial section of each composition descends from the ceiling or rises from the wall, or even from the floor, and then hangs thanks to dedicated straps.

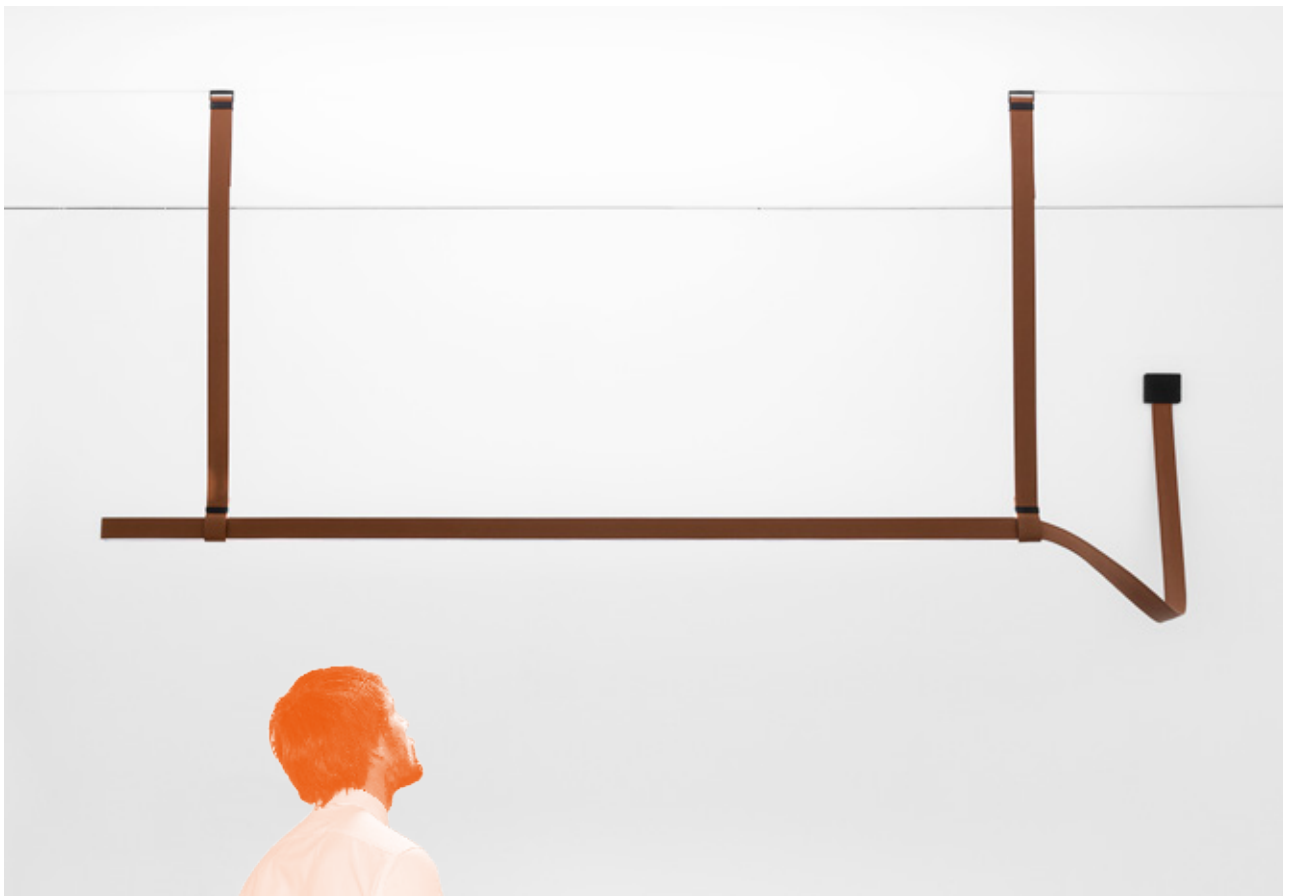
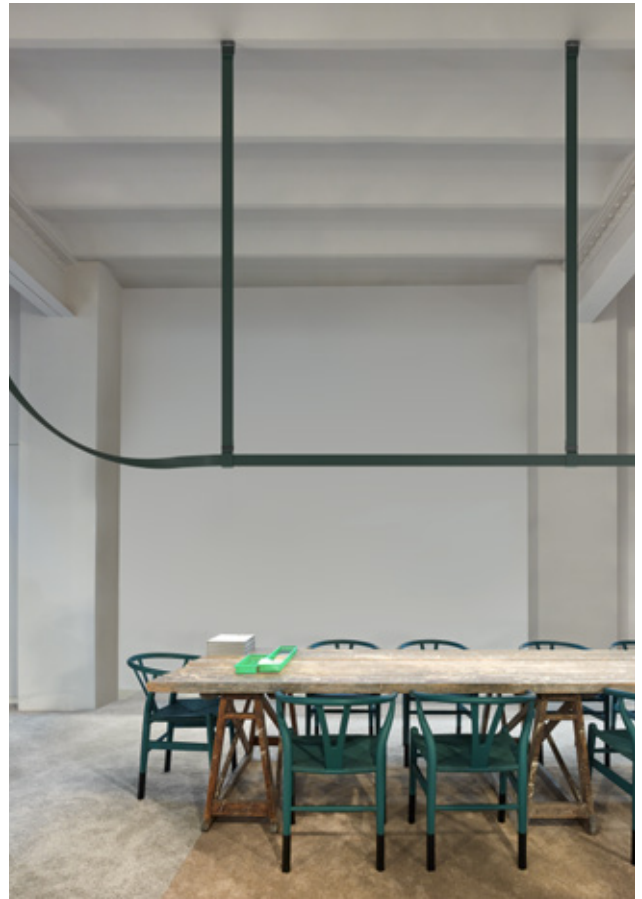

FULL VISUAL COMFORT

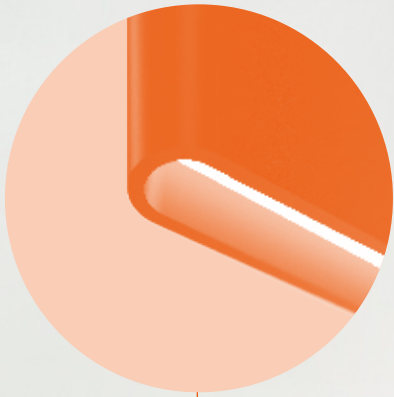

Comme pour attacher une ceinture, l'installation des sangles utilisées pour accrocher le profilé lumineux se fait en glissant les lanières dans des boucles métalliques qui font office de crochets de plafond. Chaque sangle est ajustable pour respecter ainsi la configuration de la pièce.

As for fastening a belt, the installation of the straps used to hang the lighting profile is done by sliding the straps through dedicated metal buckles that act as ceiling hooks. Each strap can be adjusted to respect the configuration of the environment.

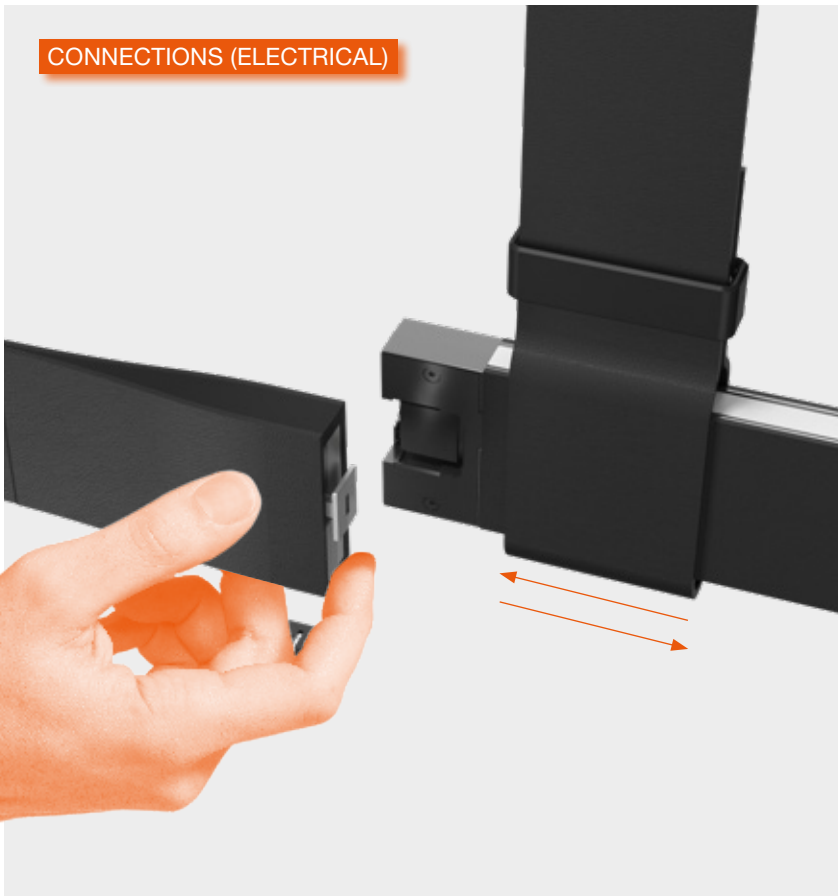

CONNECTIONS (ELECTRICAL)

Le microconnecteur spécial intégré dans la borne du profilé lumineux permet d'effectuer la connexion électrique d'un simple clic. L'élément de connexion est caché à l'intérieur de la lanière, qui agit comme une suspension pour supporter la composition.

The special micro-connector integrated in the terminal of the lighting profile allows the electrical connection to be made with a simple click. The connection element is hidden inside the strap that acts as a suspension to support the composition.

CONNECTIONS (ELECTRICAL)







La longueur des profilés lumineux et des sangles peut varier en fonction des exigences du projet. Six longueurs différentes sont disponibles dans la gamme. Elles permettent à la composition de s'adapter à l'espace en grandissant, en tournant, en montant ou en descendant en trois dimensions.

The length of the lighting profiles and the straps can be changed according to the requirements of the project. The range offers six different lengths so the composition can be adapted to the space by growing, rotating, rising or descending in three dimensions.

PROFILES

3000 mm



2000 mm



STRAPS

3000 mm



2000 mm



1500 mm



1000 mm











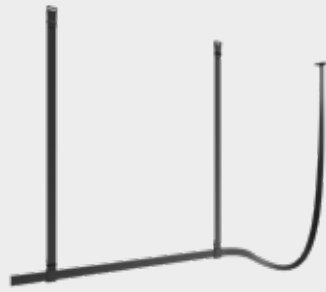

TOP LED
27,5W/m

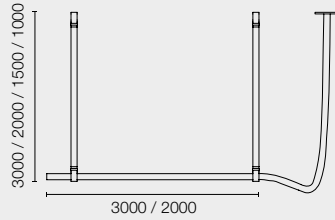

■ GN Green



■ 18 Natural Leather



■ 14 Black



■ GO Grey Olive



■ M5 Copper Brown



Flood
Up&Down

FLOS
CONTROL BY CASAMBI



INFRA-STRUCTURE

INFRA-STRUCTURE
INFRA-STRUCTURE

INFRA-STRUCTURE

INFRA-STRUCTURE

INFRA-STRUCTURE
INFRA-STRUCTURE

INFRA-STRUCTURE

INFRA-STRUCTURE

INFRA-STRUCTURE

INFRA-STRUCTURE
INFRA-STRUCTURE

INFRA-STRUCTURE
INFRA-STRUCTURE

INFRA-STRUCTURE

Structure tubulaire compatible avec une large gamme de luminaires à fixation magnétique et blocage mécanique de sécurité. Réglage et variation par protocoles universels et à travers l'application FLOS Control®.

Tubular structure compatible with a wide range of light fixtures with magnetic fastening and mechanical safety locking. Regulation and control with universal protocols and using the FLOS Control® application.

INFRA-STRUCTURE





The Conran Shop, Seoul

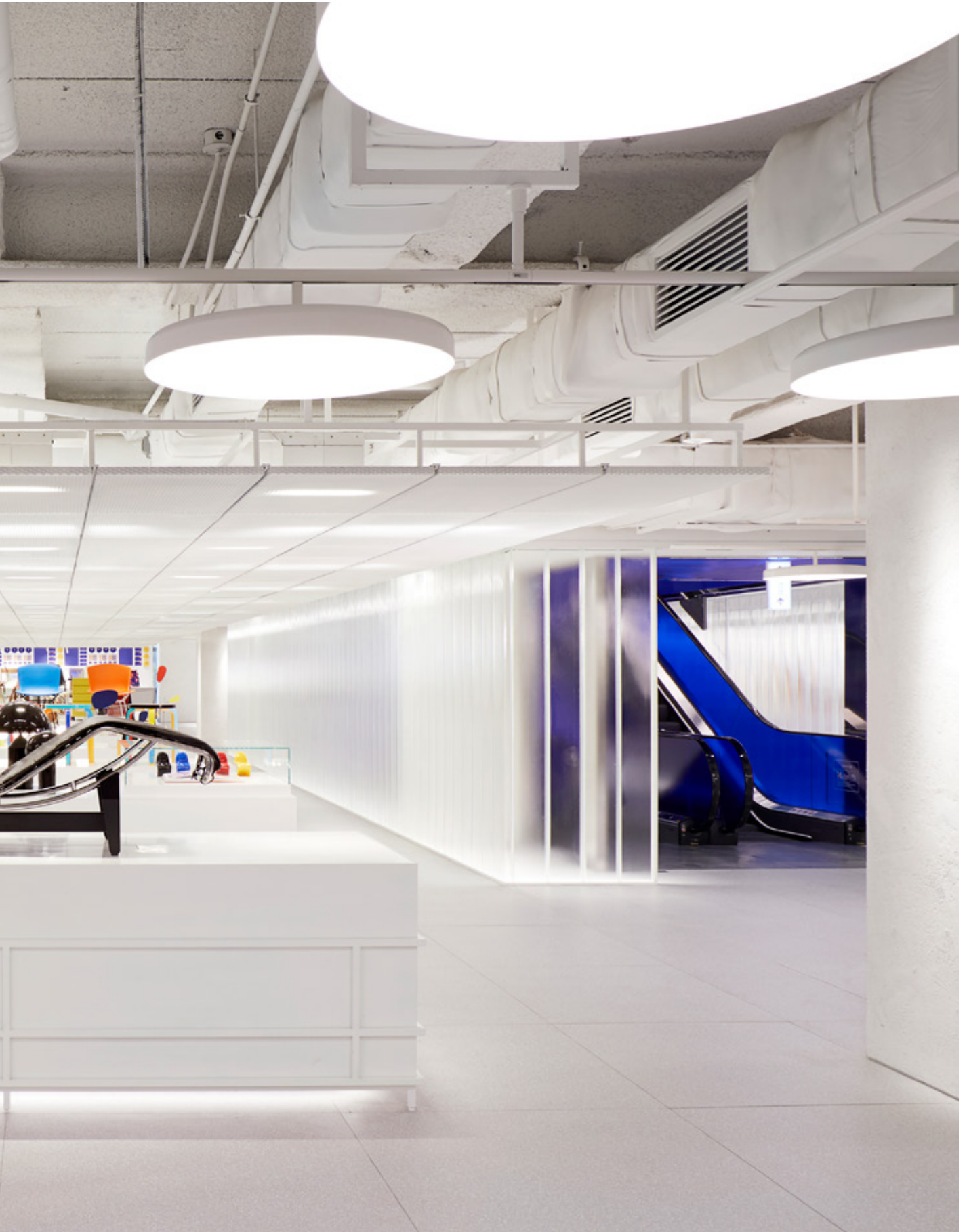

La nouvelle icône des structures lumineuses : grâce à son design unique et à sa technologie magnétique, Infra-Structure offre une manière originale de développer la conception lumineuse de votre espace architectural. Compatible avec tous les systèmes de variation et FLOS Control®.

The new icon in lighting structures: thanks to its unique design and magnetic technology Infra-Structure offers a singular way to grow your lighting design in the architectural space. Compatible with all control systems and FLOS Control®.



- 1 SPOT / LIGHT SHADOW SPOT
- 2 LIGHT TUBE
- 3 SUSPENSION PANEL
- 4 SUSPENSION GLASS DOWNLIGHT
- 5 MULTIFUNCTION SMART DEVICE











Vincent Van Duysen
Offices, Belgium
Bottom

Cantina 51 - Parc 51,
Belgium
Top

LIGHT TUBE / SUSPENSION PANEL 600

Diffuseur opale à haut rendement, qui permet une distribution uniforme et garantit un haut confort visuel.

Highly efficient opal diffuser, which allows for uniform distribution and guarantees high levels of visual comfort.

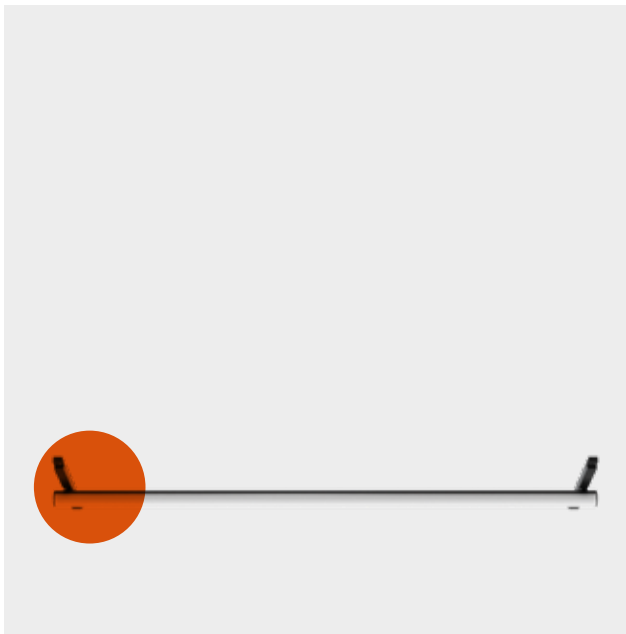

SPOT / LIGHT SHADOW SPOT

Infra-Structure propose des projecteurs *Spot* et *Light Shadow Spot*. Les modules d'éclairage *Spot* sont dotés de réflecteurs à haute efficacité, tandis que les *Light Shadow Spots* bénéficient de leur propre technologie optique unique et brevetée, avec des lentilles à double foyer. (1)

Infra-Structure has *Spot* and *Light Shadow Spot* projectors. Spot light modules feature high-efficiency reflectors, while *Light Shadow Spots* benefit from their own patented and exclusive optical technology, with dual-focus lenses. (1)



SUSPENSION GLASS / DOWNLIGHT 110

Cloche décorative en verre soufflé. Disponible en finition transparent, fumé et rouge.

Decorative bell in blown glass. Available in transparent, fumeed and red finishes.

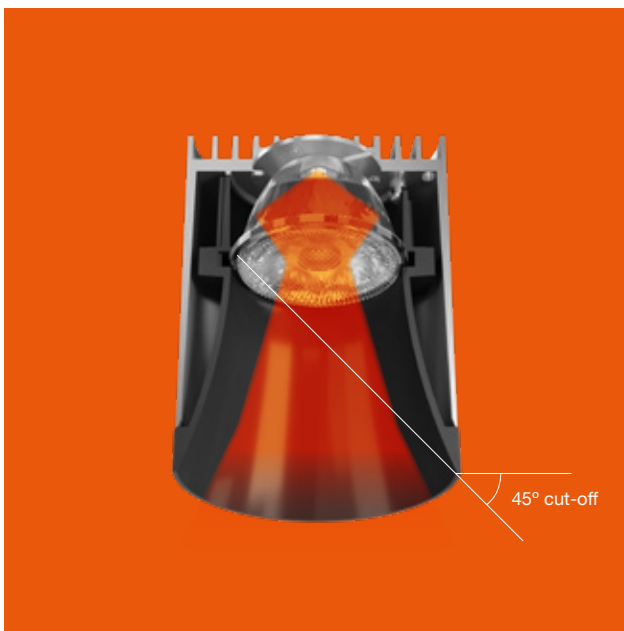











Vincent Van Duysen
Offices, Belgium

	Différentes options de contrôle peuvent être adaptées à n'importe quel besoin.	Different control options that can be adapted to any need.
ON BOARD DIMMING	Chaque luminaire possède son variateur intégré, pour un contrôle direct et individuel.	Each luminaire has its own integrated dimmer for direct and individual control.
DALI	Contrôle individuel de chaque luminaire.	Individual control of each luminaire.
1-10V	Contrôle à distance en broadcasting (variation de tous les luminaires dans un seul groupe).	Broadcasting remote control (dimming of all the luminaires in a single group).
CASAMBI	Disponible avec contrôle individuel de chaque luminaire avec une application sur tablet ou smartphone (FLOS Control®).	Individual control of each luminaire directly through a tablet or smartphone application (FLOS Control®).



FLOS CONTROL®
BY CASAMBI

L'application FLOS Control® permet de contrôler les appareils d'éclairage du système individuellement ou par groupe, en contrôlant les scènes et la programmation.

Il suffit d'une installation électrique traditionnelle et du Gateway connecté par Bluetooth pour obtenir un contrôle total de l'espace.

Disponible pour IOS et Android

The FLOS Control® application allows you to control the system's luminaires individually or as a group, controlling scenes and programming.

With a traditional electrical installation and the Gateway connected by Bluetooth, you obtain total control of the ambience.

Available for iOS and Android

LIGHT MODULES

SUSPENSION
PANEL 600



TOP LED
40W

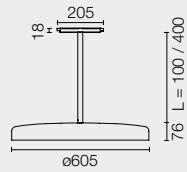

SUSPENSION
GLASS DOWNLIGHT 110



LED ARRAY
13,5W

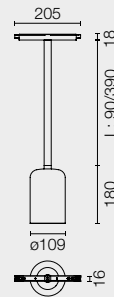

□ 40 Blanc
40 White

■ 14 Noir
14 Black

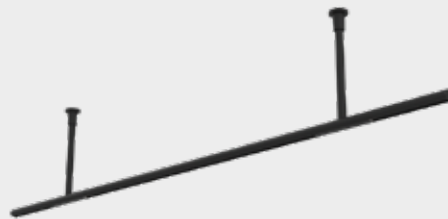

MULTIFUNCTION
SMART DEVICE



FLOS CONTROL®
by Casambi

FLOS
CONTROL BY CASAMBI



INFRA-STRUCTURE
EPISODE 2

INFRA-STRUCTURE
EPISODE 2

INFRA-STRUCTURE
EPISODE 2

INFRA-STRUCTURE
EPISODE 2

INFRA-STRUCTURE
EPISODE 2

INFRA-STRUCTURE
EPISODE 2

INFRA-STRUCTURE
EPISODE 2

INFRA-STRUCTURE
EPISODE 2

Structure tubulaire sobre, incroyablement polyvalente. Grâce à un système de connexion spécial, il est possible de combiner des éléments verticaux et horizontaux à l'aide de modules linéaires et géométriques pour créer des combinaisons tridimensionnelles dans des variations infinies.

Subtle, incredibly versatile tubular structure. Thanks to a special connection system, it is possible to combine vertical and horizontal elements to create three-dimensional combinations in infinite variations using linear and geometric modules.

INFRA-STRUCTURE Episode 2



La réinterprétation d'une icône : le design unique de l'Infra-Structure évolue grâce à un nouveau concept modulaire extrêmement simplifié. Les éléments sobres mais du plus bel effet visuel peuvent être combinés pour distinguer tout espace architectural grâce à une forte présence scénique.

The reinterpretation of an icon: the unique design of Infra-Structure evolves thanks to a new, extremely simplified modular concept. The subtle but visually stunning elements can be combined to characterize any architectural space with a strong stage presence.



- 1 SUSPENSION CONE
- 2 STRUCTURAL RODS
- 3 LIGHT TUBE DIRECT
- 4 LIGHT TUBE INDIRECT
- 5 SUSPENSION PANEL



SUSPENSION CONE

Le module conique assure un blindage complet de la source lumineuse. Il intègre une unité optique spéciale brevetée permettant d'obtenir des effets professionnels de lumière ponctuelle à fort contraste.

The conical module provides total shielding of the light source and integrates a special patented optical unit to achieve professional high-contrast spotlighting effects.



LIGHT TUBE

Des modules linéaires horizontaux peuvent être utilisés pour obtenir de la lumière directe et indirecte. Ils représentent un signe graphique important dans la structure, créant un rythme et une continuité visuelle dans l'installation grâce à une lumière douce et diffuse.

The horizontal linear modules can be used to obtain direct and indirect light. They represent an important graphic sign in the structure, creating rhythm and visual continuity in the installation through soft and diffused light.

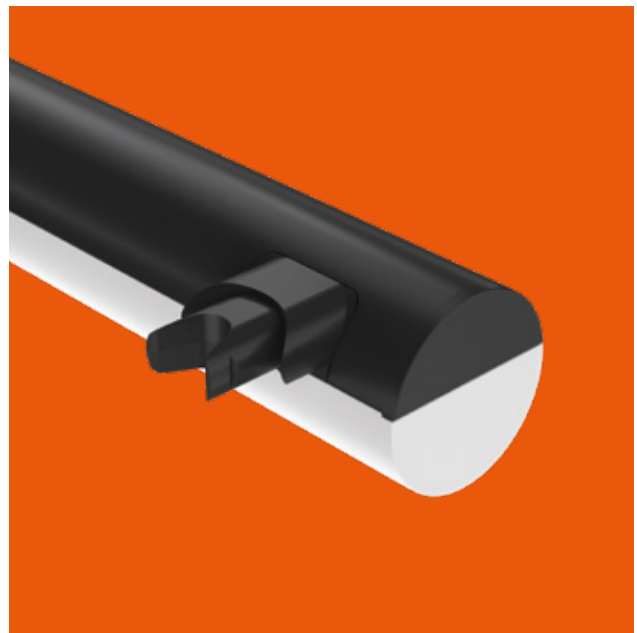

SUSPENSION PANEL

Le panneau circulaire est fabriqué avec un crochet spécial qui le rend très facile à installer sur la structure. Le profilé intérieur présente une finition noire contrastante avec le grand diffuseur opale à haute efficacité qui garantit un confort visuel absolu.

The circular panel is manufactured with a special hook that makes it very easy to install on the structure. The internal profile features a black finish that contrasts with the large, highly efficient opal diffuser, guaranteeing high levels of visual comfort.



LIGHT TUBE COVERED

Le module linéaire trapézoïdal protège la vue de l'émission directe de lumière en agissant comme un écran pour le diffuseur opale du luminaire et en concentrant la lumière sur la surface de travail.

The trapezoidal linear module protects the eyes from direct light emission by acting as a screen for the opal diffuser of the luminaire and by concentrating the light on the work surface.









La connexion mécanique entre les modules individuels composant la structure est réalisée au moyen d'un système de vis qui garantit une installation rapide et sûre. Chaque module est verrouillé à l'aide d'une petite vis de pression presque invisible une fois l'installation terminée.

The mechanical connection between the individual modules that make up the structure is made through a screw system that guarantees a fast and safe installation. Each module is locked in place by integrating a small, almost invisible grub screw once the installation is complete.



Les connexions électriques des modules d'éclairage sont extrêmement faciles à réaliser. Chaque élément d'éclairage est complété par un long câble électrique 5 m équipé d'un microconnecteur de sortie. Le câble passe par les différentes sections de la structure verticale et est ensuite connecté au réseau central au plafond.

The electrical connections of the lighting modules are extremely simple to make. Each lighting element is completed by a long 5m electrical cable equipped with an output micro-connector. The cable runs through all the different sections of the vertical structure and is then connected to the central grid in the ceiling.









CONFIGURATION

L'extrême simplicité des éléments et la rapidité avec laquelle ils peuvent être combinés permettent de libérer la créativité du projet en réalisant d'innombrables combinaisons.

CONFIGURATION

The extreme simplicity of the elements and the speed with which they can be combined allows to free up the creativity of the project and to achieve innumerable combinations.

EXAMPLE NO.1

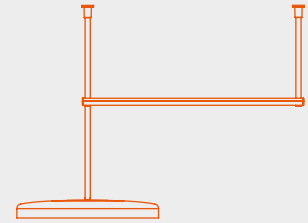

- 2 x Top Anchor
- 2 x Light Tube Rod 400mm
- 1 x Direct Light Tube 900mm
- 1 x Suspension Rod 400mm
- 1 x Suspension Panel 600mm
- 1 x End Cap

EXAMPLE NO.2



- 4 x Top Anchor
- 2 x Light Tube Rod 400mm
- 4 x Light Tube Rod 200mm
- 2 x Direct Light Tube 900mm
- 1 x Indirect Light Tube 900mm
- 4 x End Caps

EXAMPLE NO.3

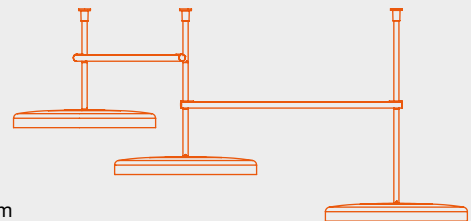

- 3 x Top Anchor
- 1 x Light Tube Rod 400mm
- 3 x Light Tube Rod 200mm
- 1 x Indirect Light Tube 900mm
- 1 x Indirect Light Tube 1500mm
- 1 x Suspension Rod 400mm
- 2 x Suspension Rod 200mm
- 3 x Suspension Panel ø600mm

EXAMPLE NO.4

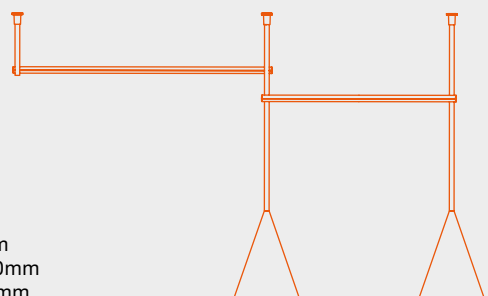

- 3 x Top Anchor
- 2 x Light Tube Rod 200mm
- 2 x Light Tube Rod 100mm
- 1 x Suspension Rod 200mm
- 1 x Indirect Light Tube 1200mm
- 1 x Indirect Light Tube 900mm
- 2 x Suspension Rod 400mm
- 2 x Suspension Cone ø300
- 1 x End Cap

Comme dans un réseau tridimensionnel, il suffit de définir les axes verticaux de la structure, puis de les relier visuellement (et électriquement) à des modules d'éclairage qui peuvent tourner librement à 360°, garantissant ainsi une incroyable souplesse d'installation.

As in a three-dimensional network, simply define the vertical axes of the structure and then connect them visually (and electrically) with lighting modules that can freely rotate 360°. An incredible installation flexibility is guaranteed.

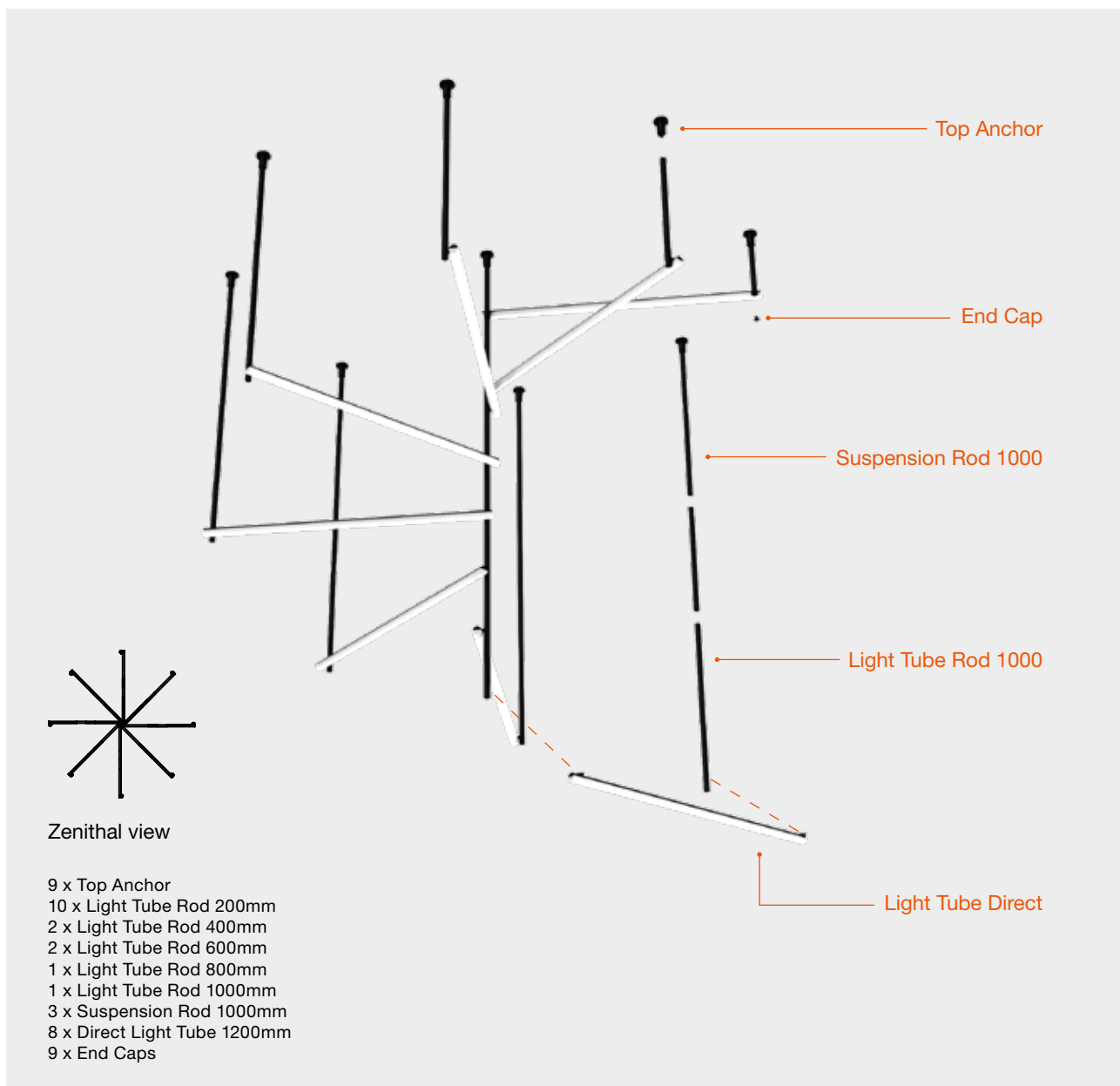





	Différentes options de contrôle peuvent être adaptées à n'importe quel besoin.	Different control options that can be adapted to any need.
DALI	Contrôle broadcast de chaque luminaire.	Broadcast control of each luminaire.
1-10V	Contrôle à distance en broadcasting (variation de tous les luminaires dans un seul groupe).	Broadcasting remote control (dimming of all the luminaires in a single group).
CASAMBI	Disponible avec contrôle individuel de chaque luminaire avec une application sur tablet ou smartphone (FLOS Control®).	Individual control of each luminaire directly through a tablet or smartphone application (FLOS Control®).



FLOS CONTROL®
BY CASAMBI

L'application FLOS Control® permet de contrôler les appareils d'éclairage du système par groupe, en contrôlant les scènes et la programmation.

Il suffit d'une installation électrique traditionnelle et du Gateway connecté par Bluetooth pour obtenir un contrôle total de l'espace.

Disponible pour IOS et Android

The FLOS Control® application allows you to control the system's luminaires as a group, controlling scenes and programming.

With a traditional electrical installation and the Gateway connected by Bluetooth, you obtain total control of the ambience.

Available for iOS and Android

LIGHT MODULES

LIGHT TUBE
DIRECT - INDIRECT



TOP LED
24W/m

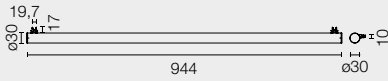

SUSPENSION
CONE Ø30



LED ARRAY
30W

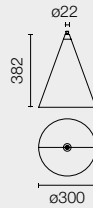

SUSPENSION
CONE Ø40



LED ARRAY
41W

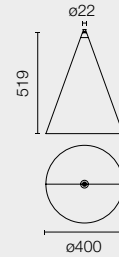

SUSPENSION
PANEL 600



TOP LED
35,5W

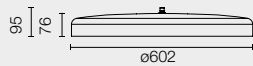

LIGHT TUBE
COVERED



TOP LED
24W/m

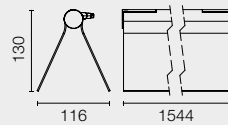

Spot



Medium



Flood



Diffused

40 Blanc
40 White

14 Noir
14 Black



FLOS
CONTROL BY CASAMBI



GUSTAVE GUSTAVE

GUSTAVE GUSTAVE

GU AVE

GUSTAV USTAVE

GUSTAV USTAVE

GUSTAV USTAVE

GUSTAV USTAVE

GUSTAV USTAVE

GUST TAVE

GUSTAVE GUSTAVE

GUSTAVE GUSTAVE

Élégant luminaire portable pour l'éclairage de tables. Émission lumineuse asymétrique à 360° d'une grande portée. Versions pour la maison et les espaces accueillant du public. Design circulaire pour éviter l'obsolescence et l'impact environnemental.

Elegant, portable luminaire for tabletop lighting. Wide range, 360°, asymmetrical light emission. Home and hospitality versions. Circular design to avoid obsolescence and environmental impact.

GUSTAVE



LUMIÈRE ASYMÉTRIQUE

Parfaite homogénéité de la lumière jusqu'à 1 mètre. Portée optimisée pour des applications archétypales sur des tables pouvant accueillir jusqu'à 4 convives. Un confort visuel imbattable.

ASYMMETRIC LIGHT

Up to 1 meter of perfect light homogeneity. Optimized reach for archetypal applications for tables hosting up to 4 guests. Unbeatable visual comfort.

ILLUMINATED AREA
OF 1 METER IN DIAMETER

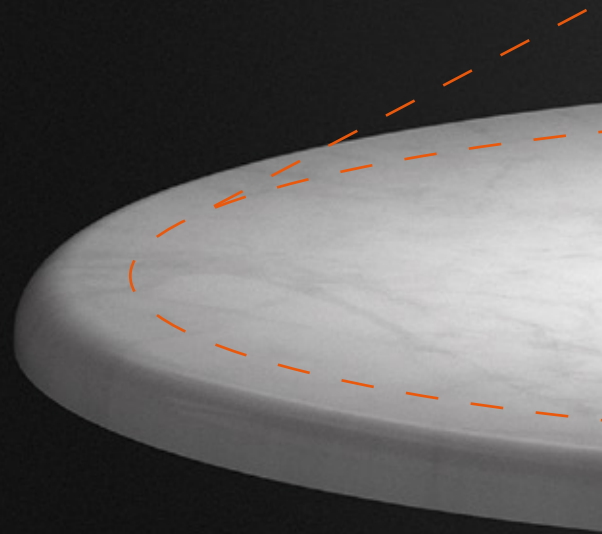



HIGH VISUAL CONFORT

360°
ASYMMETRIC
EMISSION

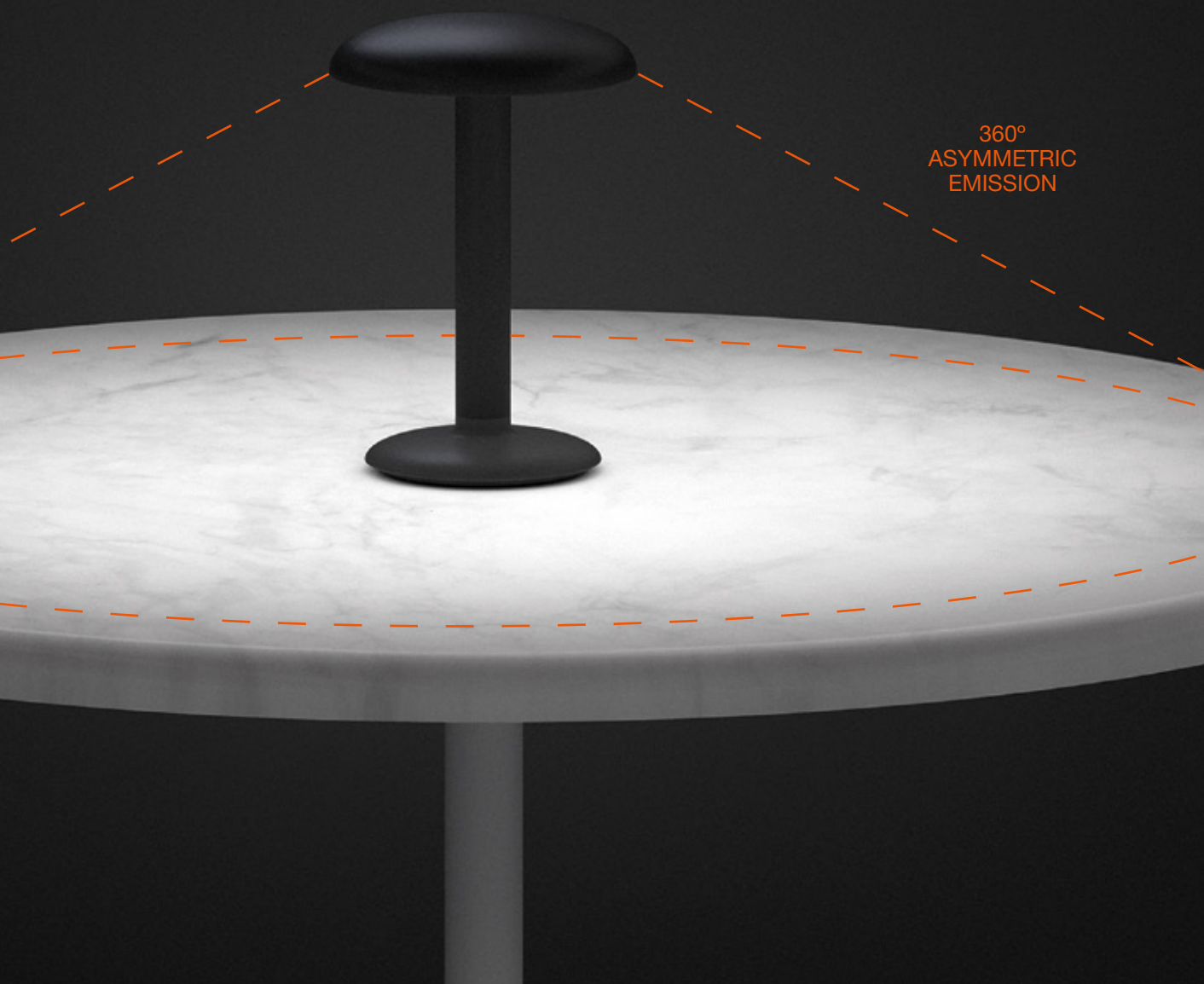







Système optique exclusif breveté par Flos. Lentilles disposées en révolution pour une émission asymétrique à 360°. Large étendue de la zone éclairée avec une occupation minimale de l'espace. Excellente qualité de lumière sur le plan de travail.

Exclusive optical system patented by Flos. Lenses arranged in revolution for a 360° asymmetrical emission. Wide extension of the illuminated area with minimum space taken. Excellent light quality on the work surface.

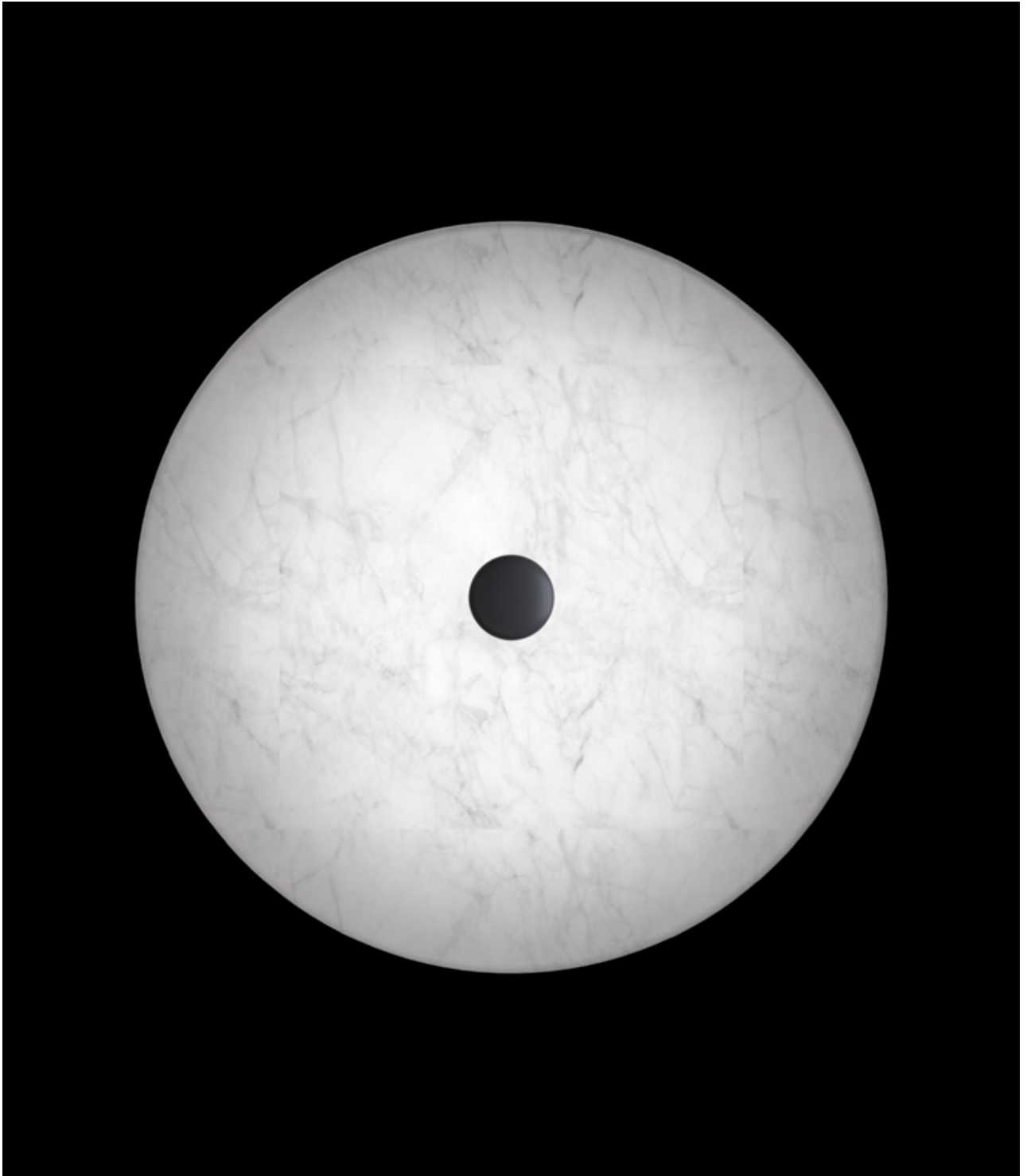





VERSION RESIDENTIAL

Le compagnon idéal pour la maison.

RESIDENTIAL VERSION

The ideal household partner.

1. Chargement via câble USB-C. Voyant LED pour la gestion de la charge et de l'autonomie. Temps de charge : 5h à 6h. Autonomie : 6h à 100 %, 10h à 50 % et 18h à 25 %.
Charging via USB-C cable. LED indicator for charge and autonomy management. Charging time: 5h to 6h. Autonomy: 6h at 100%, 10h at 50% and 18h at 25%.

2. Protocole de fonctionnement intégré pour optimiser l'autonomie de l'appareil en cas de batterie faible.
Integrated operating protocol to optimize product autonomy in case of low battery.

3. Régulation séquentielle 0-100% par bouton tactile capacitif. Le clignotement de la lumière indique que l'intensité maximale ou minimale est atteinte. Mémoire de la dernière position.
0-100% sequential regulation by means of capacitive touch button. Flashing light indicates when the maximum or minimum intensity is reached. Last position memory.

VERSION HOSPITALITY

Le partenaire idéal pour les restaurants.

HOSPITALITY VERSION

The perfect partner for restaurants.

1. Alimentation par batteries amovibles type « pile ». Retrait et remplacement faciles des piles pour éviter les interruptions de service. Chargement externe des piles via un chargeur dédié. Temps de charge en fonction des caractéristiques du chargeur utilisé. Autonomie : 12h à 100 %, 24h à 50 % et 48h à 25 %. Voyant LED pour gérer la durée d'autonomie.

Powered by removable batteries. Easy removal and change of batteries to avoid service interruptions. External battery charging by dedicated charger. Charging time depending on the characteristics of the charger used. Autonomy: 12h at 100%, 24h at 50% and 48h at 25%. LED indicator for autonomy management.

2. Protocole de fonctionnement intégré pour optimiser l'autonomie de l'appareil en cas de batterie faible.
Integrated operating protocol to optimize product autonomy in case of low battery.

3. Régulation en 3 étapes (25 %, 50 %, 100 %), pour faciliter l'uniformité entre les unités Gustave qui partagent l'espace.
3-step dimming (25%, 50%, 100%) to facilitate uniformity between the Gustave units sharing a space.



CONTRÔLE HAPTIQUE ET VOYANT LED

HAPTIC CONTROL & LED INDICATOR

Bouton tactile capacitif pour interagir avec le luminaire : allumage, extinction et régulation. Haptique avancée, sensation perçue de haute qualité.

Voyant LED pour gérer la durée d'autonomie. Dans la version Residential, il fournit également des informations sur le processus de chargement de l'appareil.

Capacitive touch button for interaction with the luminaire: switching on, off and dimming. Advanced haptics, high quality perceived sensation.

LED indicator for autonomy management. In the Residential version, it also informs about the charging status of the product.

HAUTEMENT ÉTANCHE

HIGH WATERTIGHTNESS

Indice de protection IP54 contre la pénétration de la poussière et de l'eau. Résistant aux éclaboussures, à la pluie légère et à la saleté dans des conditions normales d'utilisation. Créé pour illuminer aussi bien un dîner à la maison que les services sur la terrasse ou dans la salle d'un restaurant.

IP54 protection rating against dust and water ingress. Resistant to splashes, light rain and dirt in normal use. Created to provide lighting both for dinners at home and services on the terrace or in the dining room of a restaurant.

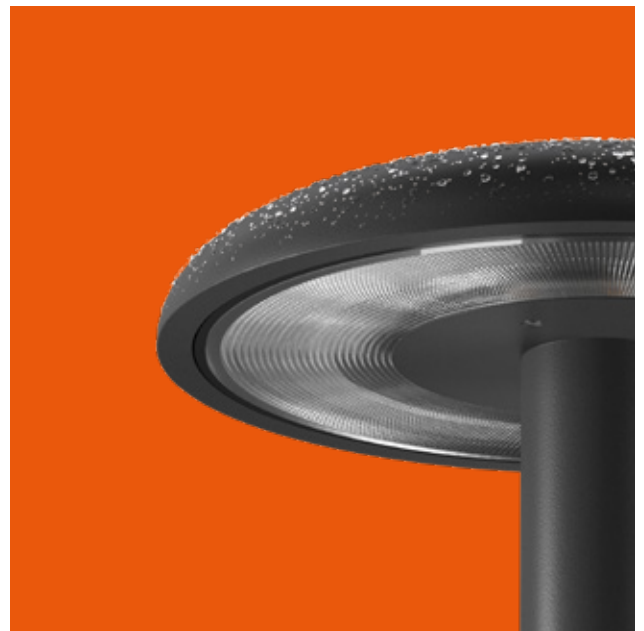



DESIGN CIRCULAIRE. INGÉNIERIE CONTRE L'OBSOLESCENCE

Gustave (Hospitality & Residential) est alimenté par des piles lithium-ion remplaçables. Ainsi, la durée de vie de l'appareil n'est pas liée à la durée de vie des batteries. Lorsque les piles atteignent la fin de leur cycle de vie, elles peuvent être remplacées par de nouvelles. L'appareil continue à fonctionner comme au premier jour.

En outre, lorsque l'appareil arrive en fin de vie, son concept de design circulaire permet de démonter facilement toutes les pièces et de les séparer pour les recycler. Le tout sans outils : il est fabriqué sans colle, sans vis et sans soudures.

CIRCULAR DESIGN. ENGINEERING AGAINST OBSOLESCENCE

Gustave (Hospitality & Residential) is powered by replaceable lithium-ion batteries. Thus, the life of the product is not linked to the life of the batteries. When the batteries reach the end of their life cycle, they can be replaced with new ones. The product continues to function as it did on the first day.

Moreover, when the product comes to an end, its circular design concept allows all parts to be easily disassembled and separated for recycling. All without the need for tools: it is manufactured without glues, screws or welding.

FLOS *for Planet*



Une gamme proposant sept finitions. Une sélection minutieuse pour que Gustave puisse s'adapter à toute sorte de décoration intérieure. Style et différenciation inégalés.

Range of seven finishes. A careful selection for Gustave to adapt to any type of interior design. Pure style and differentiation.



7 couleurs

Finitions exclusives mat et brillant sélectionnées par Vincent Van Duysen :
1. Matt White, 2. Matt Anthracite, 3. Laquered Brown, 4. Laquered Green, 5. Polished Silver, 6. Smooth Black, 7. Raw Aluminum.

7 colors

Exclusive matte and glossy finishes selected by Vincent Van Duysen: 1. Matt White, 2. Matt Anthracite, 3. Laquered Brown, 4. Laquered Green, 5. Polished Silver, 6. Smooth Black, 7. Raw Aluminum.



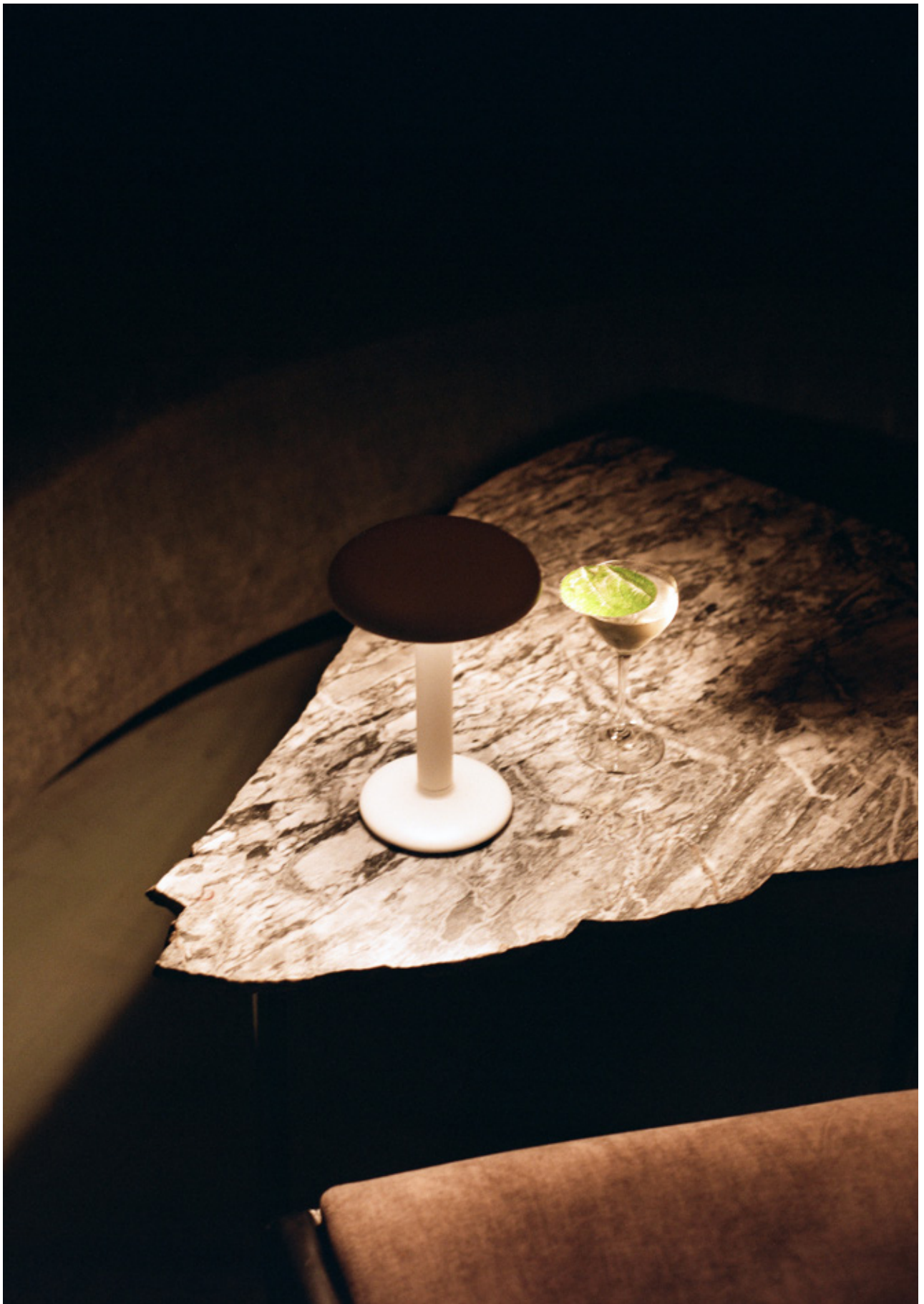

GUSTAVE HOSPITALITY
(Rechargeable batteries)

GUSTAVE RESIDENTIAL
(USB-C cable)



TOP LED
2,3W

TOP LED
2,5W

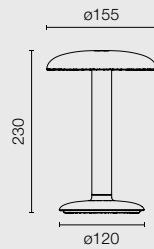

□ Matt White



■ Matt Anthracite



■ Laquered Brown



■ Laquered Green



▨ Polished Silver



■ Smooth Black



■ Raw Aluminum



Asymmetric
Flood 360°

EMI

EMI

EMI

EMI

EMI

EMI

EMI

EMI

EMI

EMI

EMI

Emi, conçue par Erwan Bouroullec, combine différentes sources de lumière avec un grand confort visuel pour créer une expérience unique d'ombre et de lumière. Le design de cette collection naît du regroupement de trois modules lumineux à l'intérieur d'extrusions linéaires et compactes qui donnent à la lampe la forme triangulaire qui se reflète dans l'ensemble de son design.

Emi, designed by Erwan Bouroullec, combines different light sources with a high level of visual comfort to create a unique experience of light and shadow. The design of this collection comes from grouping together three light modules inside compact, linear extrusions that give the lamp a triangular shape which is reflected all throughout its design.

EMI

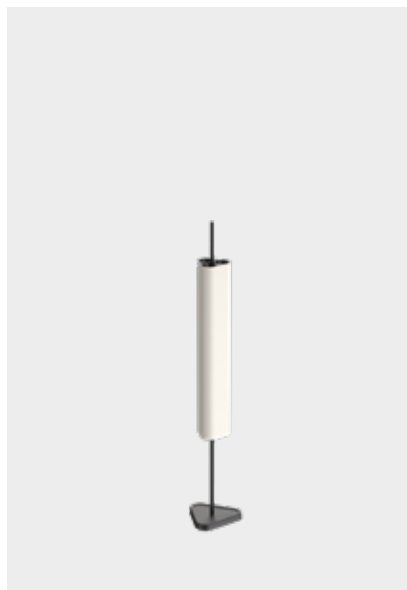

EMI FLOOR & TABLE

La version sur pied semble flotter dans les airs, allégée par une tige qui la relie à la base. L'éclairage bidirectionnel offert par ce modèle est particulièrement adapté à la vie contemporaine : la lumière supérieure est suffisamment puissante pour éclairer tout l'espace sans éblouir, grâce à une conformation spécifique du faisceau. Douce et diffuse, la lumière inférieure est parfaite pour être utilisée avec d'autres sources telles qu'une télévision ou un appareil électroménager. La version de table fonctionne de la même manière, mais elle est plus petite et s'adapte à la perfection à toute surface horizontale.

The floor version seems to float in the air, disencumbered by a stem that connects to the base. The two-way lighting offered by this model is highly adapted to contemporary life: the upper light is powerful enough to illuminate the entire space without dazzling, thanks to a specific beam conformation. The lower light is soft and subdued, perfect for use with other sources such as a television or appliance. The table version operates in the same way but is smaller in size and fits perfectly on any horizontal surface.

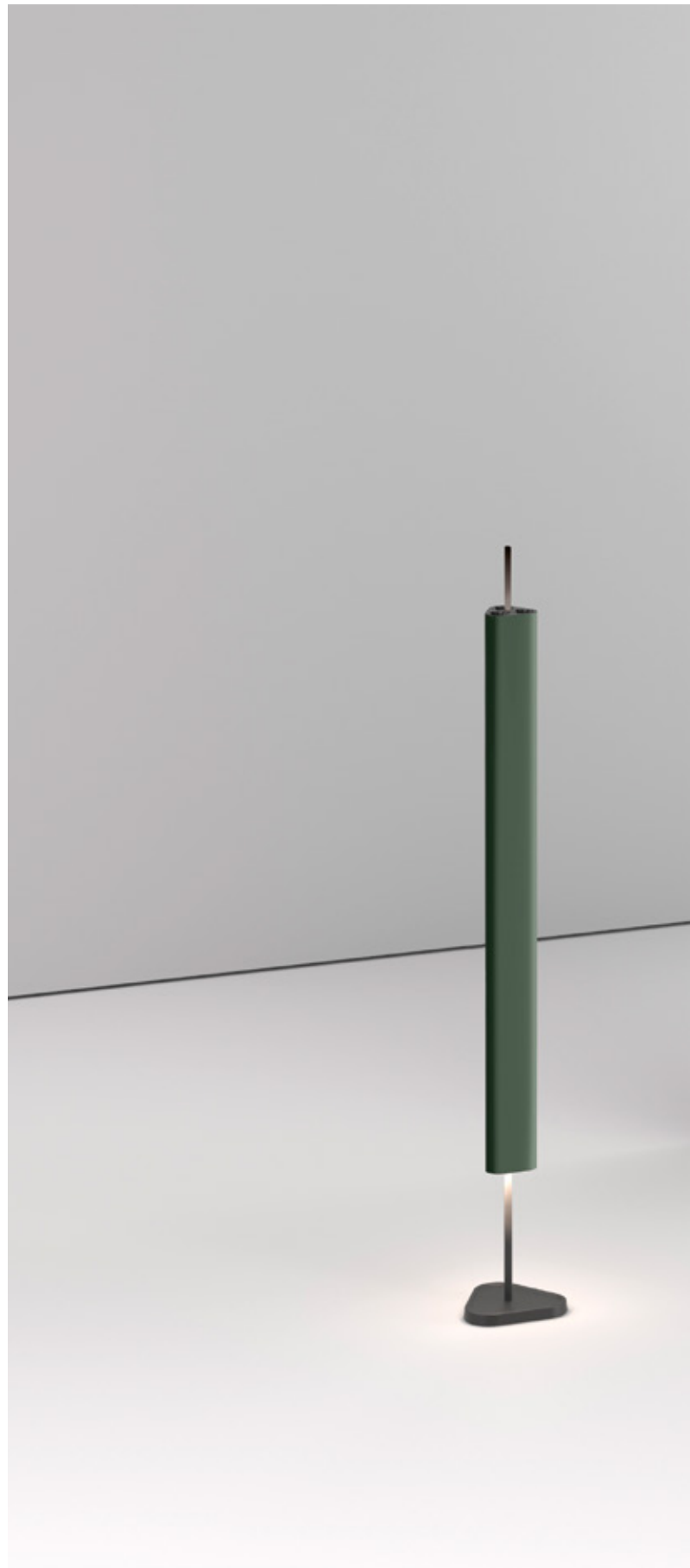







Dans sa version plafond, EMI se présente comme un élément à la fois décoratif et technique, avec une esthétique raffinée et élégante et un éclairage efficace, puissant et visuellement très confortable.

In the ceiling version, EMI is both a decorative and a technical element, with refined, elegant aesthetics and powerful and visually very comfortable effective lighting.

Le Emi profite des avantages d'une lentille innovante en silicone qui permet un contrôle extrême du faisceau en plus d'une efficacité absolue, une résistance à la chaleur et une distribution lumineuse de qualité maximale.

Emi exploits the benefits of an innovative silicone lens that allows absolute beam control with an extreme efficiency, heat resistance and maximum quality light distribution.



1 Lentilles en silicone microtexturées.
Micro-textured silicone lenses.

2 Atténuateur cut-off complet
intégré.
Integrated full cut-off attenuator.

3 Pièces détachées.
Spare parts.

FLOS TECHNOLOGY

Le kit optique disponible comprend 4 ouvertures différentes du faisceau lumineux pour *Ceiling Small*, 3 pour *Ceiling Large* et 1 pour les versions *Floor* et *Table*. Chaque lentille a été conçue pour une application particulière. Qu'il s'agisse de faisceaux lumineux ou d'effets d'éclairage diffus, le contrôle optique est toujours exceptionnel et les lumières parasites sont totalement absentes.

The available lens kit includes 4 different apertures for the beam of light for *Ceiling Small*, 3 for *Ceiling Large* and 1 for the *Floor* and *Table* versions. Every lens has been developed for a special application. Whether it is for intense beams of light or diffused lighting effects, the optical control is always exceptional and there is absolutely no spurious light.

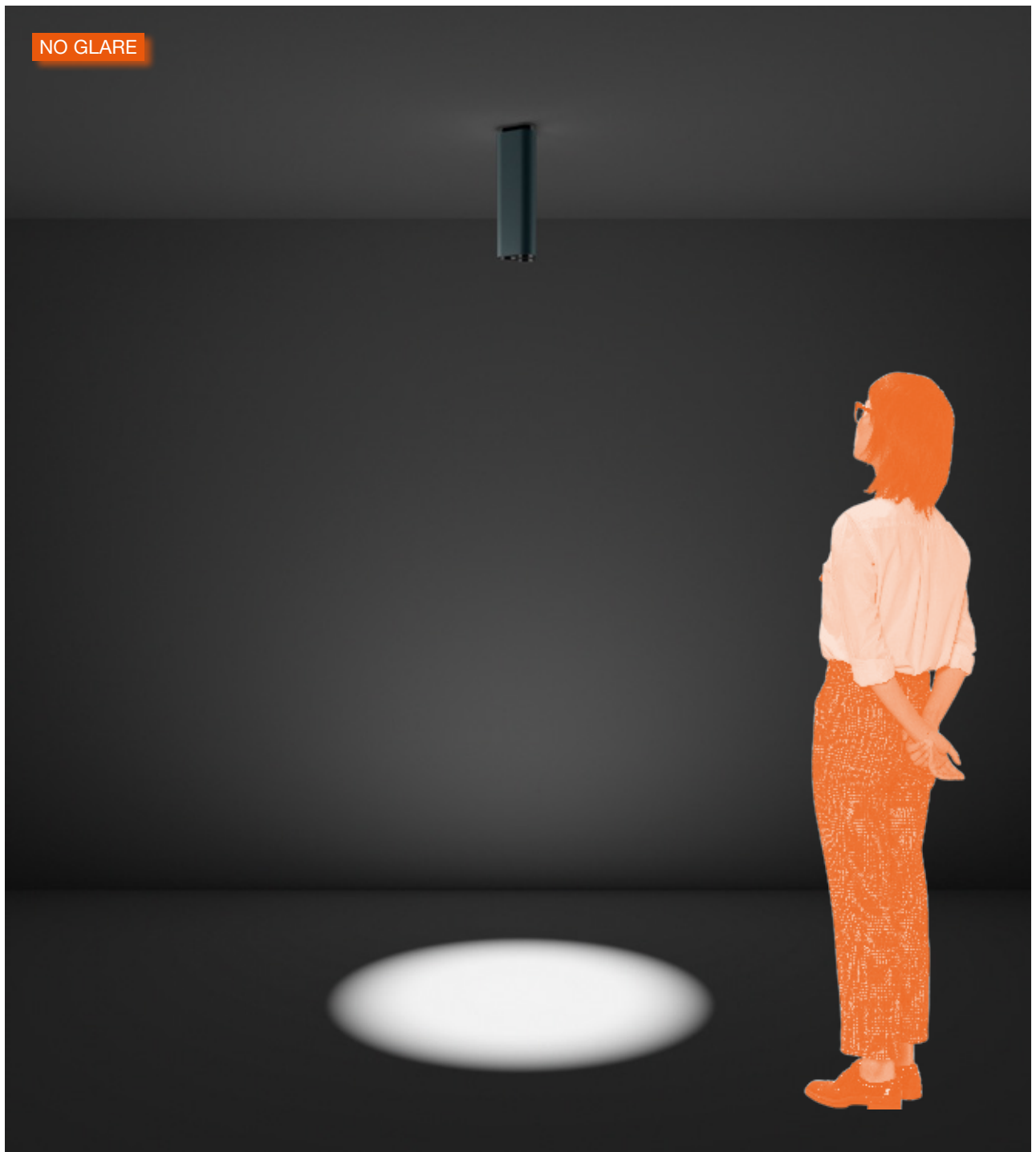

Même allumée, EMI dissimule sa source lumineuse et génère un magnifique effet visuel : l'espace est éclairé sans révéler l'origine de la lumière.

Even when on, EMI hides its light source and generates a magnificent visual effect: the space is illuminated without showing where the light source is.

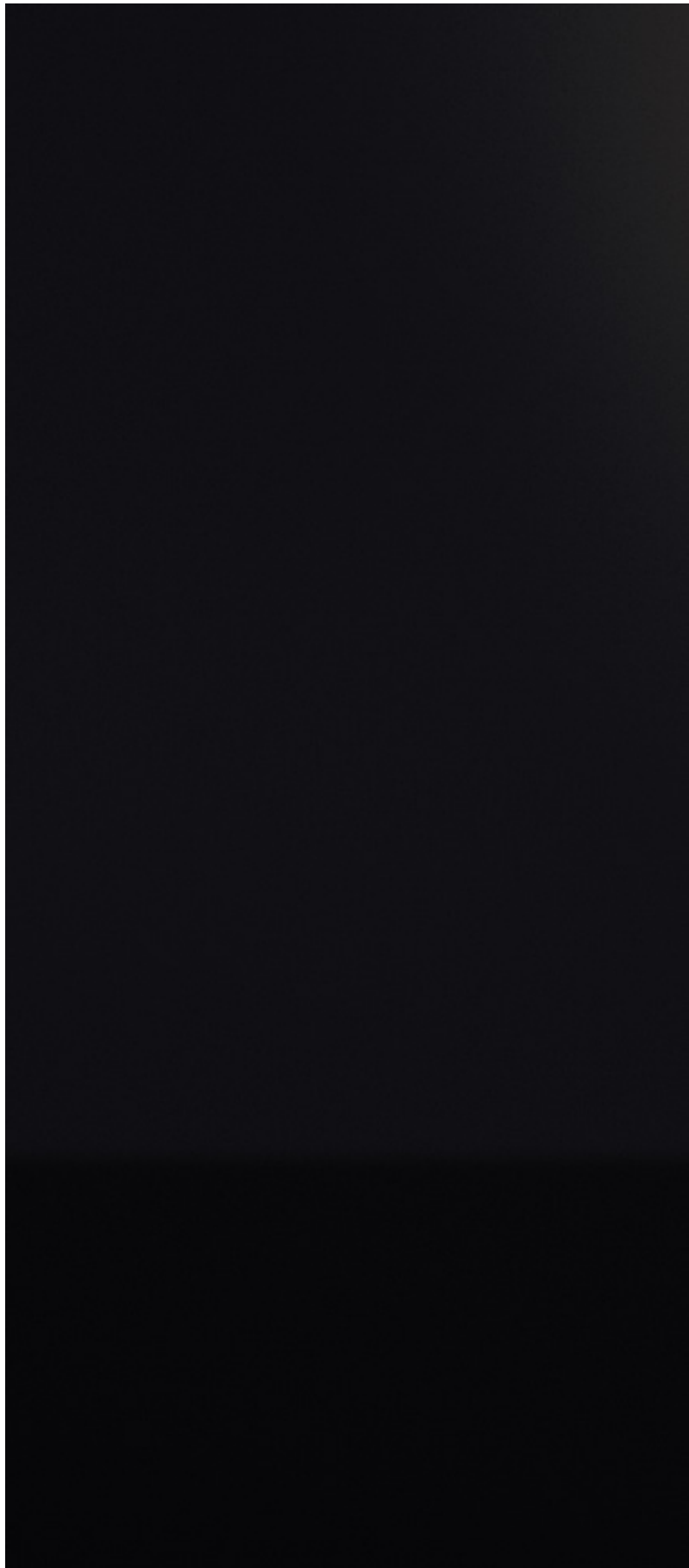



Grâce à la solution optique exclusive et brevetée, le Emi contrôle des angles cut-off extrêmes sans compromettre la haute efficacité et l'incroyable polyvalence du produit.

Thanks to the unique patented optical solution, Emi controls extreme cut-off angles without altering the high efficiency and incredible versatility of the product.

UGR<10

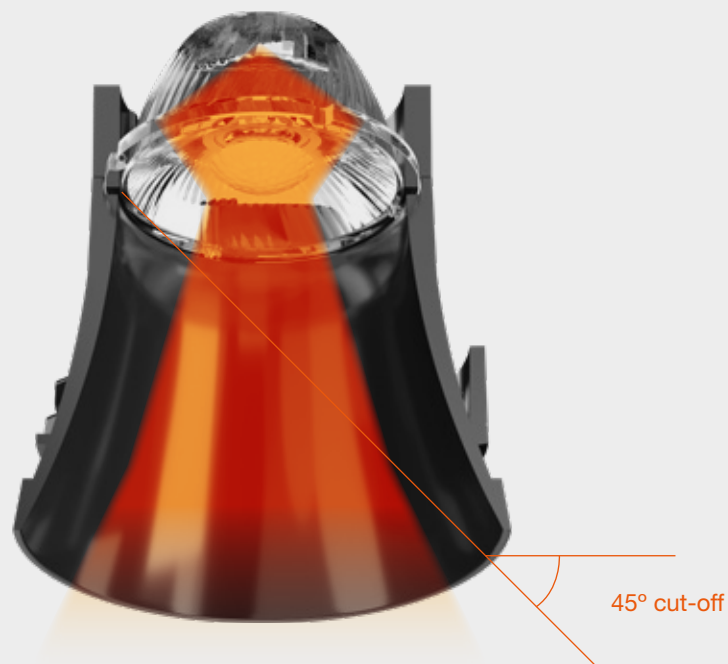

Lentille à double foyer développée par FLOS spécifiquement pour ce produit. Elle assure un contrôle optique maximal et une homogénéité exceptionnelle du faisceau lumineux.

Dual-focus lens developed by FLOS specifically for this product. It ensures maximum optical control and exceptional light beam homogeneity.













La collection Emi est disponible en trois versions : au plafond, au sol et de table. Cette variété permet d'adapter la lumière d'Emi aux espaces domestiques et *hospitality*.

The Emi collection is available in three versions: ceiling, floor and table. This variety helps adapt the light of Emi to spaces both at home and in hospitality.



L'utilisation répétée d'un langage similaire dans tous les modèles permet de créer plusieurs corps lumineux avec un langage commun, qui peuvent être disposés dans l'espace grâce à l'itération, l'alignement et la symétrie. Cela fait d'Emi un nouveau type d'éclairage architectural qui peut être utilisé en série, offrant un design uniforme qui s'intègre parfaitement à l'architecture environnante.

The repeated use of a similar style in all the models lets you position multiple luminaires with the same style, which can be arranged in a space through repetition, alignment and symmetry. This makes Emi a new type of architectural light that can be used as a series, providing a uniform design that fits in perfectly with the surrounding architecture.



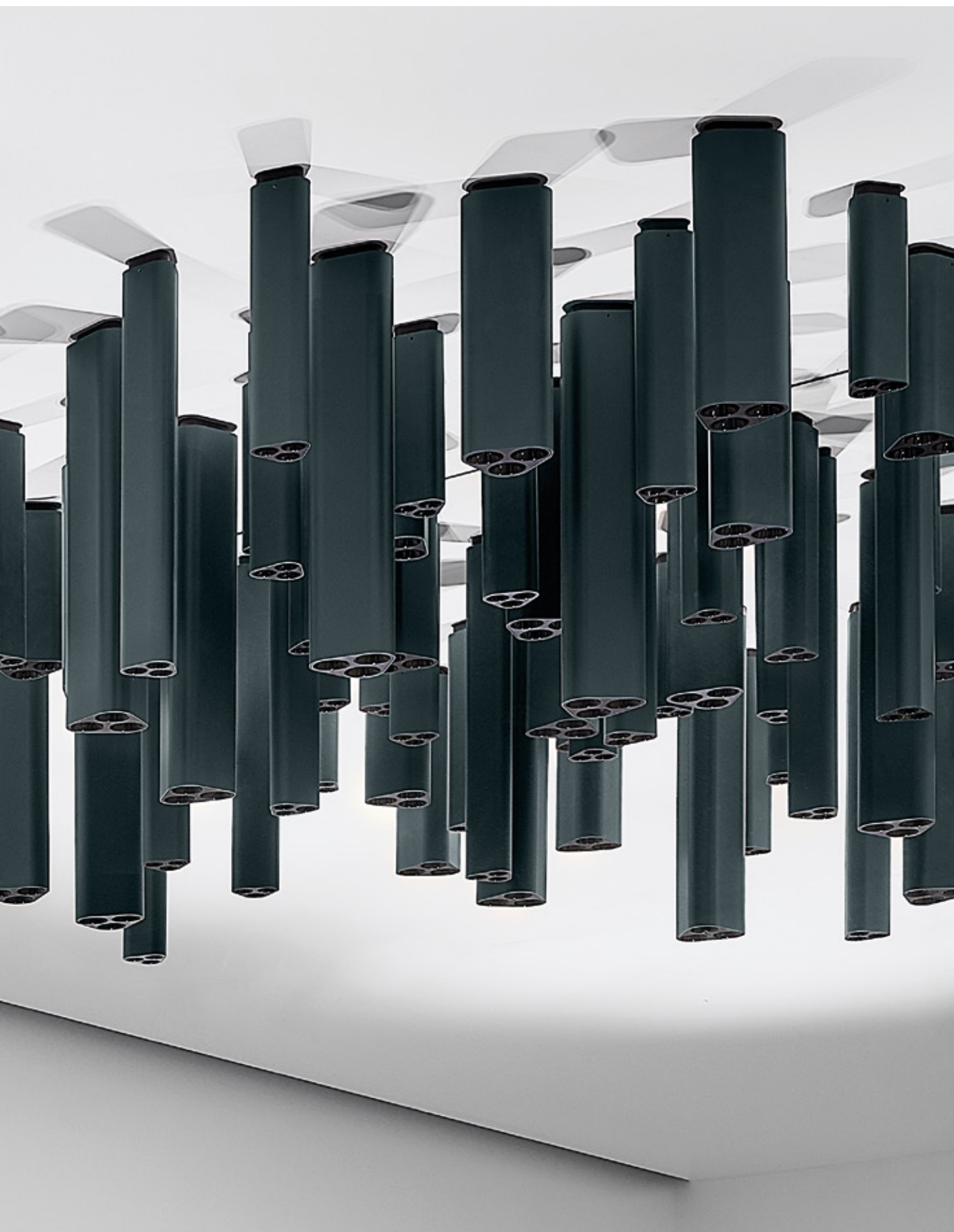

La palette de couleurs disponibles a été spécifiquement commandée par Erwan Bouroullec pour habiller le design d'EMI de quatre tonalités élégantes qui confèrent une présence magique et sculpturale à ce « roseau architectural ».

The available colour palette has been commissioned specifically by Erwan Bouroullec to cover EMI's design in four stylish shades that add a magical, sculptural presence to this "architectural reed".







EMI dispose de *Spare Parts* pour l'entretien ou le remplacement de ses groupes optiques. Chaque unité optique peut être remplacée individuellement pour faciliter l'entretien, tandis que l'absence de colle et de soudure simplifie le démontage et l'élimination correcte des pièces individuelles à la fin de la durée de vie du produit.

EMI has *Spare Parts* for maintenance or replacement of its lens units. Every lens unit can be replaced individually to make maintenance easier, while the absence of glues and welding simplifies the disassembly and correct disposal of individual parts at the useful end of the product's life.





Les modèles *Ceiling* sont disponibles avec les options de commande Non Dimming, DALI, 1-10V et Mains Dimming. Les versions *Floor* et *Table*, quant à elles, peuvent être réglées à l'aide de capteurs capacitifs Touch Dimming placés en haut de la tige centrale.

The *Ceiling* models are available with the following setting options Non Dimming, DALI, 1-10V and Mains Dimming. While the *Floor* and *Table* versions can be adjusted with Touch Dimming capacitive sensors in the top part of the central rod.

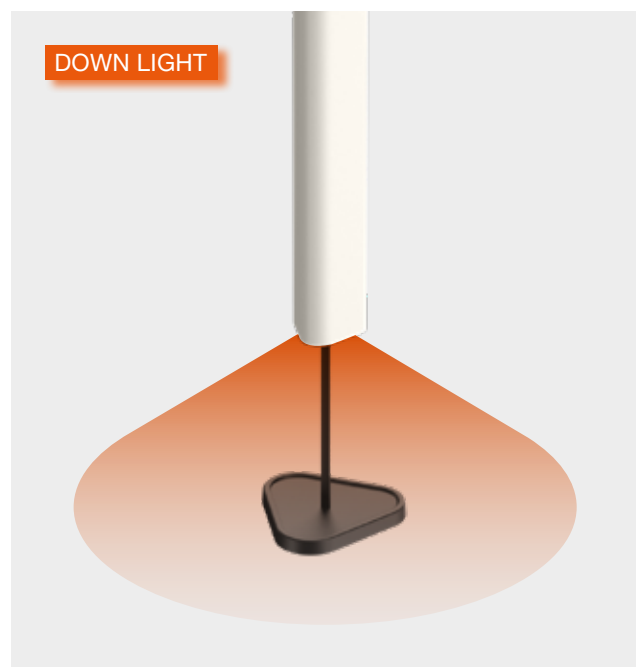





	Différentes options de contrôle pour la régulation du EMI.	Different control options for dimming EMI.
TOUCH DIMMING	Les versions <i>Floor</i> et <i>Table</i> sont dotées d'un panneau de commande capacitif intégré pour contrôler la lumière.	The <i>Floor</i> and <i>Table</i> versions have a built-in capacitive button panel to control the light.
DALI	Protocole standard pour l'intégration avec tout système de contrôle.	Standard protocol for integration with any control system.
1-10V	Contrôle à distance en broadcasting (variation de tous les luminaires dans un seul groupe).	Broadcasting remote control (dimming of all the luminaires in a single group).



EMI CEILING
LARGE
H240

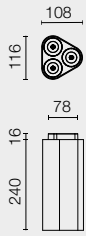

EMI CEILING
LARGE
H240



LED ARRAY
28W

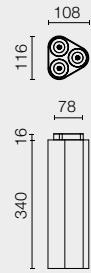

EMI CEILING
LARGE
H240

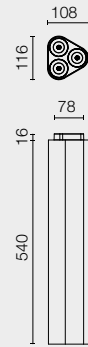

EMI CEILING
SMALL
H240

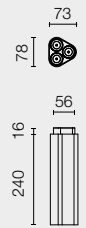

EMI CEILING
SMALL
H240



POWER LED
Up to 11W

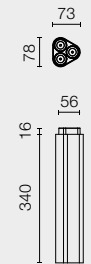

EMI CEILING
SMALL
H240

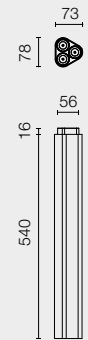

Spot



Medium



Flood



Wide Flood

EMI FLOOR



UP
LED ARRAY / 37W

DOWN
POWER LED / 12,5W

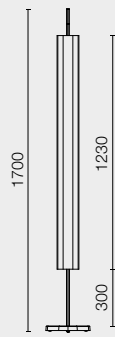

EMI TABLE



UP
LED ARRAY / 31W

DOWN
POWER LED / 12,5W

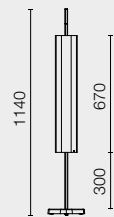

EMI CEILING

OW Off White

OW.XX All Off White

RY Deep Red

GY Deep Green

ZY Deep Blue



EMI TABLE & FLOOR

OW Off White

OW.XX All Off White

RY Deep Red

GY Deep Green

ZY Deep Blue



OBLIQUE

BB

L L

I I

Q Q

U U

E E

Oblique est un luminaire révolutionnaire : il produit un faisceau lumineux asymétrique contrôlé dont l'UGR est inférieur à 10 pour une protection anti-éblouissement exceptionnelle. Outre le modèle de table (pour les applications de bureau), Oblique Floor remplit sa fonction de manière similaire dans des applications d'éclairage d'appoint pour les fauteuils de lecture, les chaises longues et d'autres espaces, tant domestiques que professionnels.

Oblique is a revolutionary lamp: produces a controlled asymmetric light beam which UGR is lower than 10 for an exceptional anti-glare protection. Besides the table model (for desktop applications), Oblique Floor fulfills its function in an analogous way in task lighting applications for reading chairs, lounge chairs and other spaces, both domestic and professional.

OBLIQUE

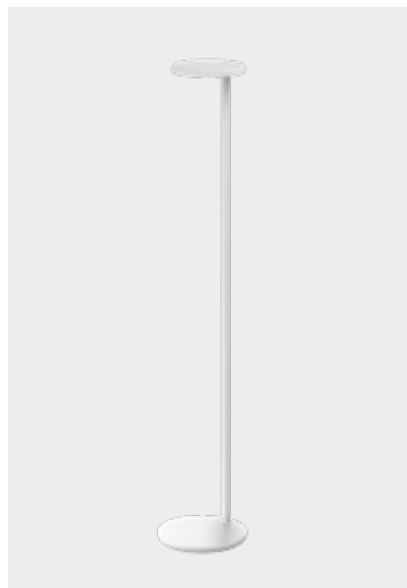



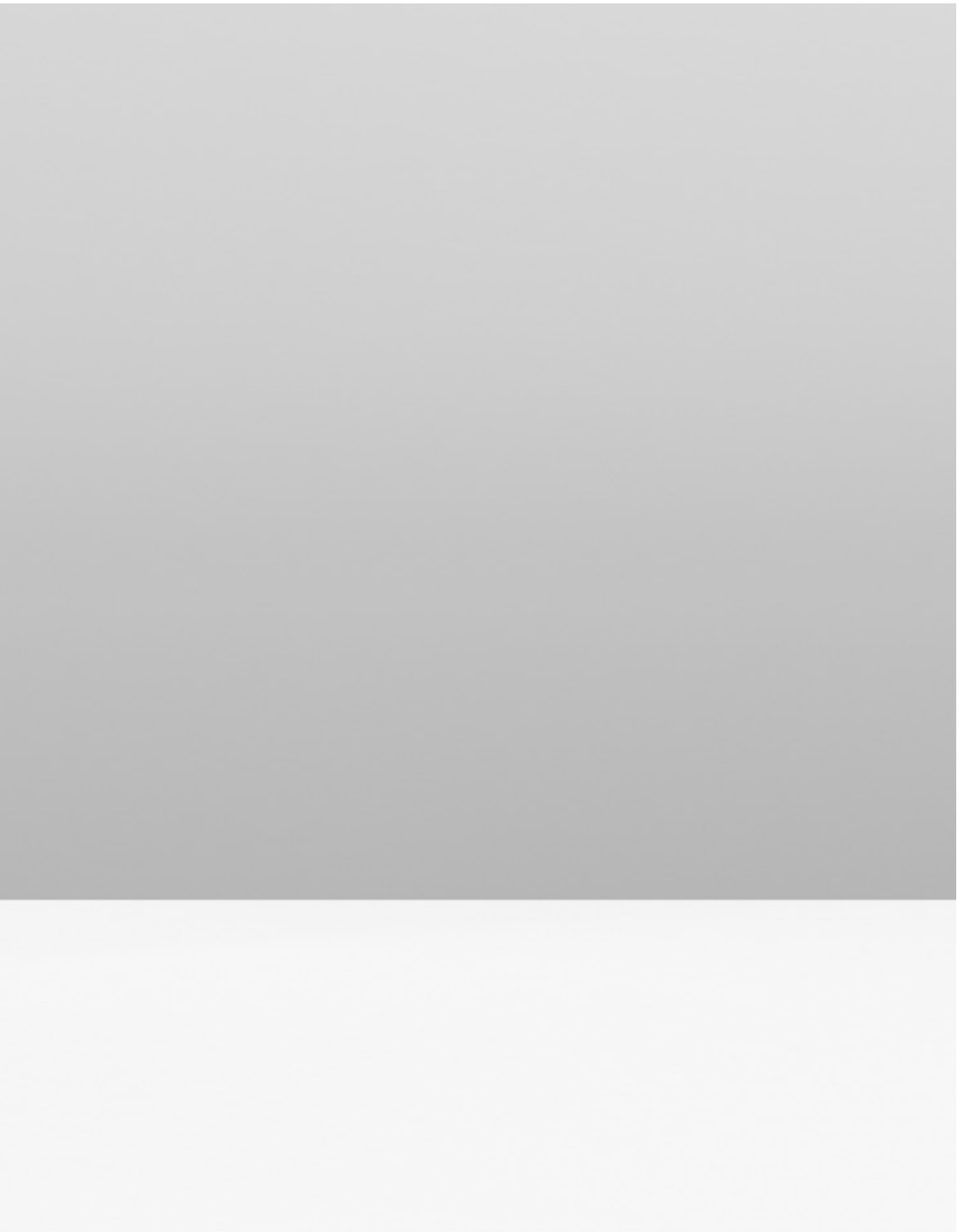

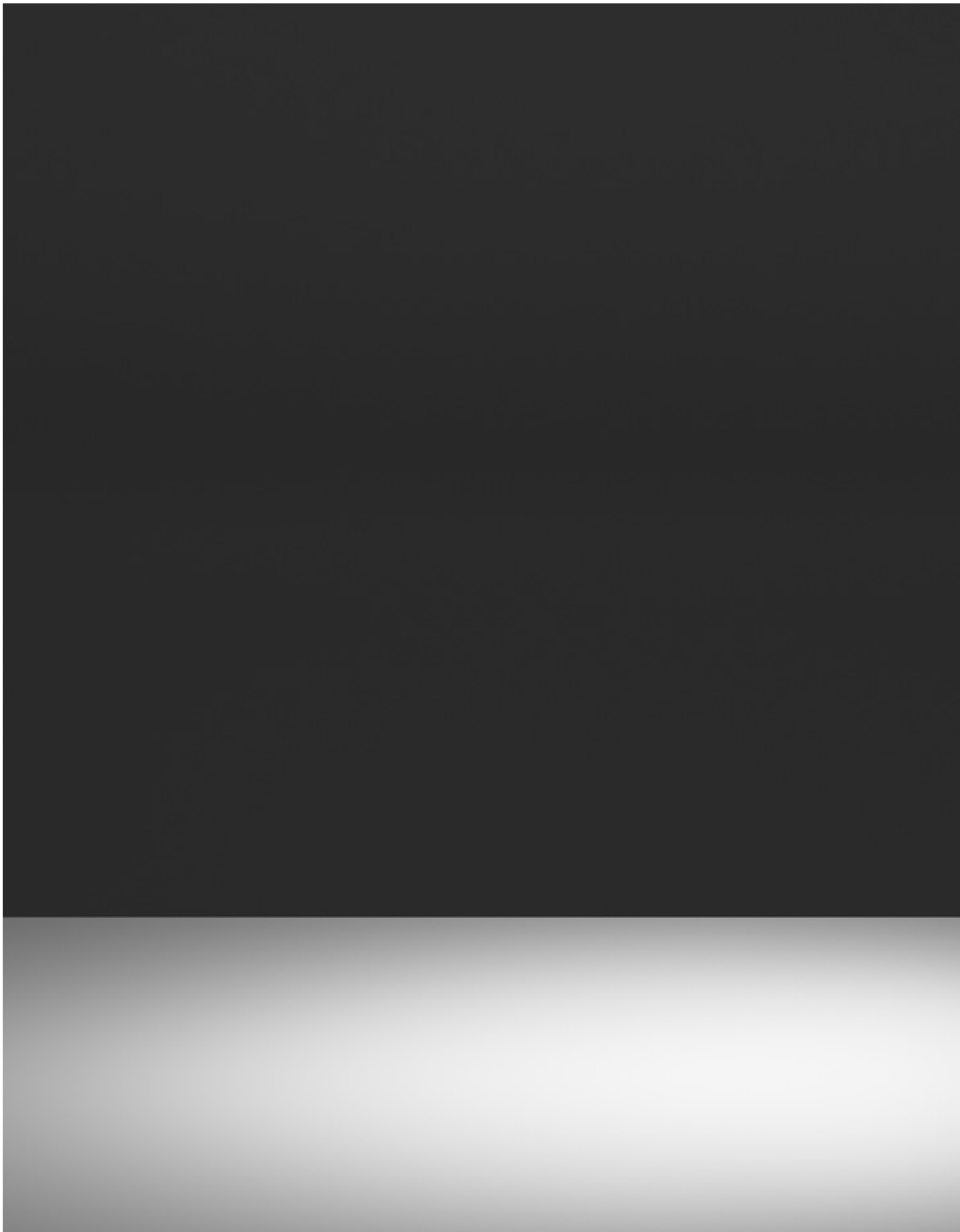





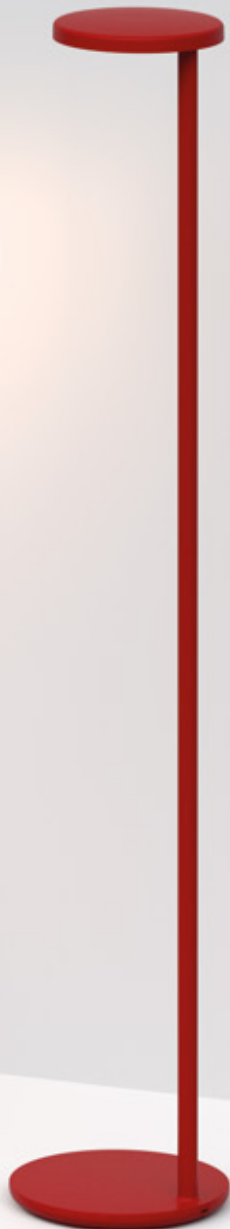

Oblique reformule l'éclairage de bureau dans les espaces de travail. Contrairement à l'archétype traditionnel du luminaire de bureau à bras articulé, Oblique est une pièce immobile, presque une sculpture. La lumière est projetée vers la zone de travail au moyen d'une émission asymétrique du faisceau, maintenant la nature statique de la pièce, sa pureté formelle et sa présence élégante. La technique de pointe et la beauté de Flos vont de pair. Oblique Floor suit la même philosophie et remplit sa fonction de manière similaire dans des applications d'éclairage d'appoint pour les fauteuils de lecture, les chaises longues et d'autres espaces, tant domestiques que professionnels.

Oblique reformulates tabletop lighting in workspaces. In contrast to the traditional archetype of the desktop luminaire with an articulated arm, Oblique is an immobile piece, almost a sculpture. The light is projected towards the work area by an asymmetrical emission of the beam, maintaining the static nature of the piece, its formal purity and its elegant presence. Technical avant-garde and Flos beauty go hand in hand.

The same philosophy is followed by Oblique Floor, which fulfills its function in an analogous way in task lighting applications for reading chairs, lounge chairs and other spaces, both domestic and professional.



Le cœur de cette lampe est le résultat d'un véritable défi technologique. Enfermées dans une épaisseur de seulement 5 mm, les LED et les lentilles sont capables de générer un faisceau lumineux extrêmement puissant et contrôlé.

The heart of this lamp is the result of a real technological challenge. The LEDs and lenses can generate an extremely powerful and controlled light beam from the inside of a just 5 mm thick space.



L'excellence du confort : UGR inférieur à 10 pour une protection anti-éblouissement exceptionnelle, une homogénéité de la distribution lumineuse et des performances en lux, conformément aux normes industrielles les plus strictes.

The excellence of comfort: UGR is lower than 10 for an exceptional anti-glare protection, homogeneity of light distribution and lux performance, in accordance to the strictest industry standards.







Lentille ultraplate brevetée avec une très haute efficacité à 97%. Tête plate arrondie pour une intrusion visuelle minimale.

Patented ultra-flat lens with a very high efficiency of 97%. Rounded flat head for minimum visual intrusion.

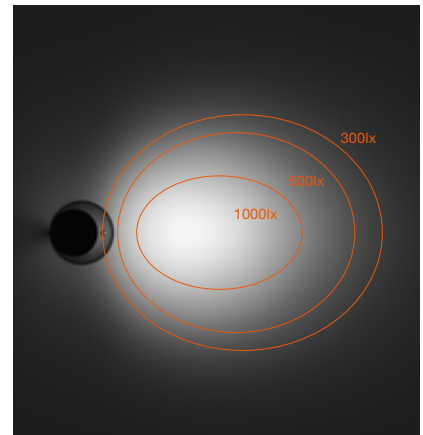

Base avec système de recharge sans fil intégré. Elle permet de charger votre smartphone sans encombrer votre bureau de fils et d'enchevêtrements peu esthétiques.

Base with integrated wireless charging system. Allows you to charge your smartphone while freeing your desk from unsightly crossed cables.



Oblique dispose toujours d'un port USB-C intégré à l'arrière de la base qui peut être utilisé pour charger des appareils supplémentaires.

Oblique always features a USB-C port integrated in the back of the base that can be used to charge additional devices.











Le bouton capacitif situé sur la partie inférieure de la tête du luminaire offre une interaction haptique de qualité supérieure et permet de contrôler le fonctionnement et la régulation d'Oblique Floor.

The capacitive button at the bottom of the luminaire head offers the highest quality haptic interaction and allows control of the functioning and dimming of Oblique Floor.

Grâce à son hauteur choisie et à l'angle asymétrique soigneusement conçu, Oblique Floor est un luminaire idéal pour l'éclairage d'appoint à côté de fauteuils ou de chaises de lecture.

Due to its chosen height and the studied asymmetrical angle of Oblique Floor, this is an ideal luminaire for reading lighting next to armchairs or reading chairs.

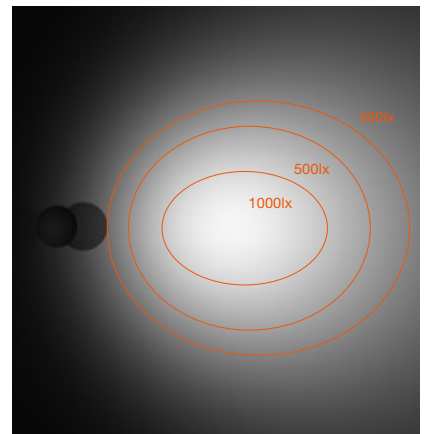

Collection disponible en différentes finitions allant du blanc, gris et anthracite classiques aux teintes pastel les plus sophistiquées, créées spécifiquement pour permettre la personnalisation de l'environnement de travail.

The collection is available in different finishes, from the classic white, grey and anthracite, to the most sophisticated pastel shades, specifically created to customize the working environment.

White / Grey / Rust / Brown / Anthracite / Salvia







OBLIQUE

OBLIQUE FLOOR



POWER LED
8W

POWER LED
8W

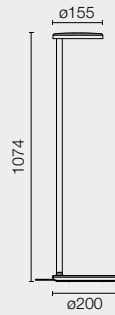
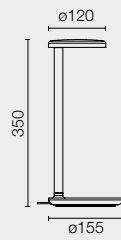

Blanc Mat
Matt White

Gris Brillant
Gloss Grey

Rouille Mat
Matt Rust

Marron Mat
Matt Brown

Anthracite Mat
Matt Anthracite

Salvia Brillant
Gloss Salvia

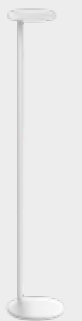

Asymmetric
Flood

DIVERSION
DIVER
DIVERSION
DIVERSION
DIVERSION
DIVERSION
DIVERSION
DIVER

Système novateur de profilés créé par Piero Lissoni. Il se caractérise par sa grande flexibilité et son minimalisme, et convient à des installations en surface et suspendues. Un rail multifonctionnel qui intègre des spots légers et de taille réduite, s'adaptant ainsi à tous les besoins architecturaux et permettant de créer des géométries à l'infini.

Innovative minimized profile system designed by Piero Lissoni for surface and suspended installation characterized by an extreme flexibility. A multifunctional rail integrating light and small spots to adapt to any architectural need allowing to create countless geometries.

DIVERSION







Les profilés peuvent se combiner pour obtenir d'innombrables options de configuration. Chaque détail a été conçu comme une partie d'un programme complet. Le résultat est une solution d'éclairage parfaitement équilibrée et très stylée, mais quasi invisible.

Profiles can combine to obtain endless configurations. Every detail has been conceived as part of a complete program, the result is a perfectly balanced, highly stylish yet almost invisible lighting solution.



- 1 SURFACE PROFILE
- 2 SUSPENSION PROFILE
- 3 ATOM SPOT









Le secret des géométries créatives et adaptables de Diversion est la rotule de connexion unique et brevetée permettant de configurer les profilés à 360° et d'en connecter facilement jusqu'à 8. Une révolution dans l'éclairage des systèmes.

The key for Diversion to achieve creative and versatile geometries is a unique patented connection joint that allows the profiles to create 360° configurations, easily connecting up to 8 profiles together. A revolution in system lighting.

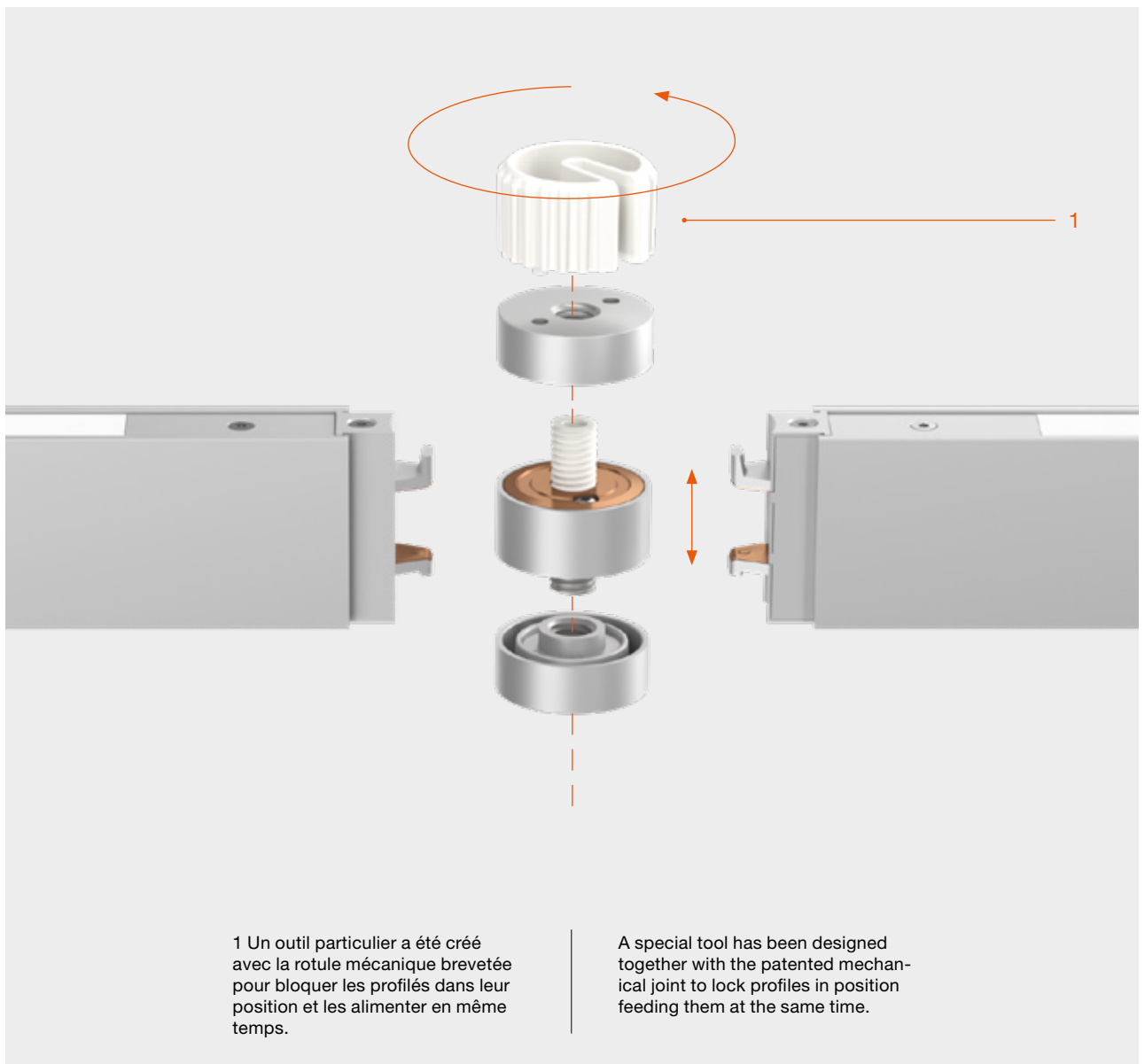

MINIMAL LINE



Une ligne minime de 34 mm de hauteur conçue grâce à la miniaturisation extrême des composants électroniques et des éléments optiques. Diversion offre une collection complète d'outils d'éclairage pour répondre à tous les besoins.

A minimal line only 34 mm height, achieved through the extreme miniaturization of the electronics and the optical bodies. Diversion offers a complete collection of lighting tools for any need.

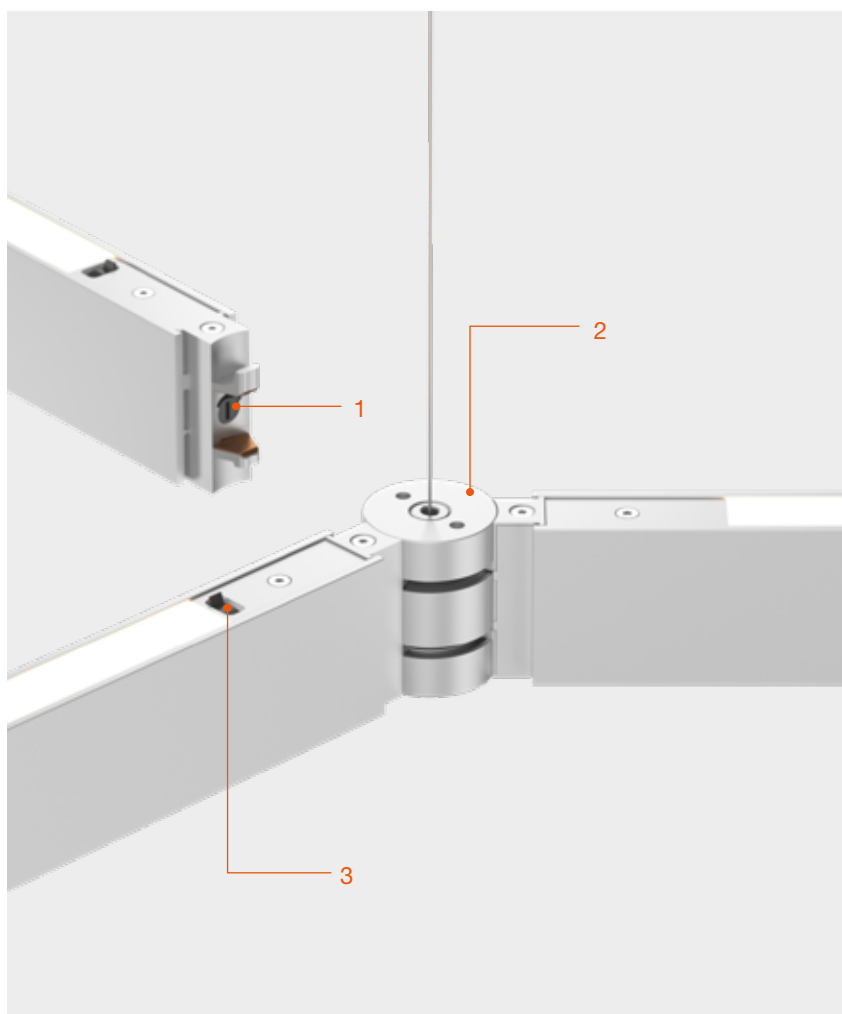

1 INTERRUPTEUR INTÉGRÉ : chaque profilé dispose d'un interrupteur intégré sur les deux extrémités. Il permet de bloquer le flux électrique, permettant ainsi d'alimenter une structure complexe depuis plusieurs points d'alimentation.
INTEGRATED SWITCH: each single profile features an embedded switch at both ends. This allows to block the electricity flow being able to feed a complex structure from multiple feeding points.

2 ROTULE BREVETÉE : le système de rotule exclusif bloque les profilés dans leur position et permet de combiner jusqu'à 8 profilés. L'électricité arrive dans les profilés redirigée par ce composant clé.
PATENTED JOINT: the special joint system locks the profiles into position allowing to combine up to 8 of them together. Electricity comes into the profiles redirected through this key component.

3 INTERRUPTEUR UPLIGHT : le système est entièrement contrôlé de façon simultanée. Néanmoins, les modules émettant de la lumière indirecte disposent d'un interrupteur sur le haut permettant de régler la lumière sur la partie haute à 50%.
UPLIGHT SELECTOR: the entire system is controlled simultaneously. Nevertheless, modules featuring indirect light emission have a top switch to dim uplight to 50%.



Les projecteurs, combinés avec la lumière douce émanant des profilés, peuvent changer de façon radicale pratiquement tous les lieux, permettant de jouer avec les contrastes et les accents de lumière.

Spotlights combined with the soft even emission that comes from all profiles can radically change the appearance of almost any scene, allowing designers to play with contrasts and highlights.

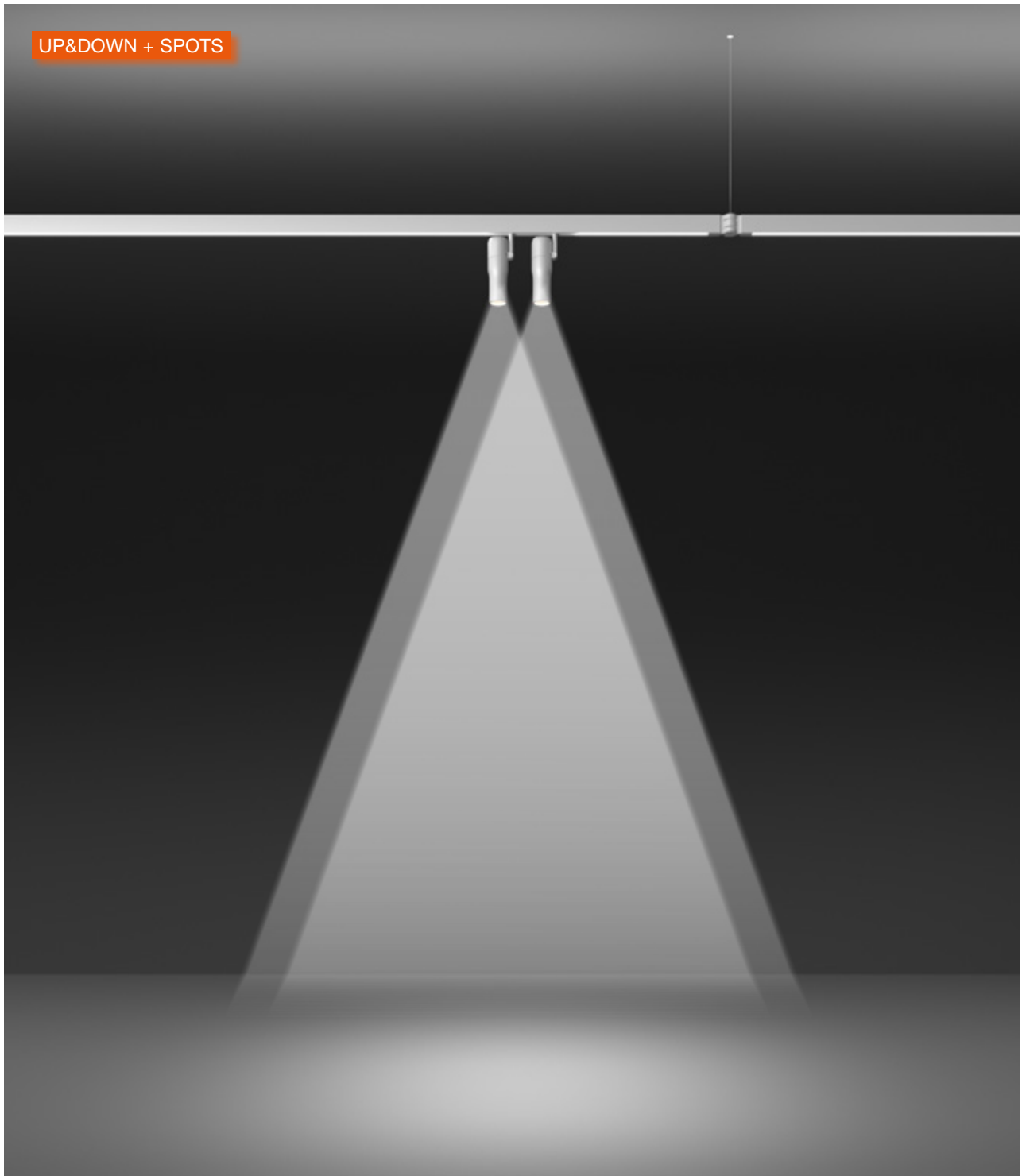

L'émission directe assure un confort visuel maximum grâce à la position très encastrée des sources LED, lesquelles restent dissimulées à la vue. L'émission indirecte offre une expérience visuelle encore plus confortable dans la pièce.

The direct emission ensures the utmost visual comfort thanks to a highly recessed position of the LED sources that remain hidden from view. The indirect emission provides an even more comfortable visual experience in the room.

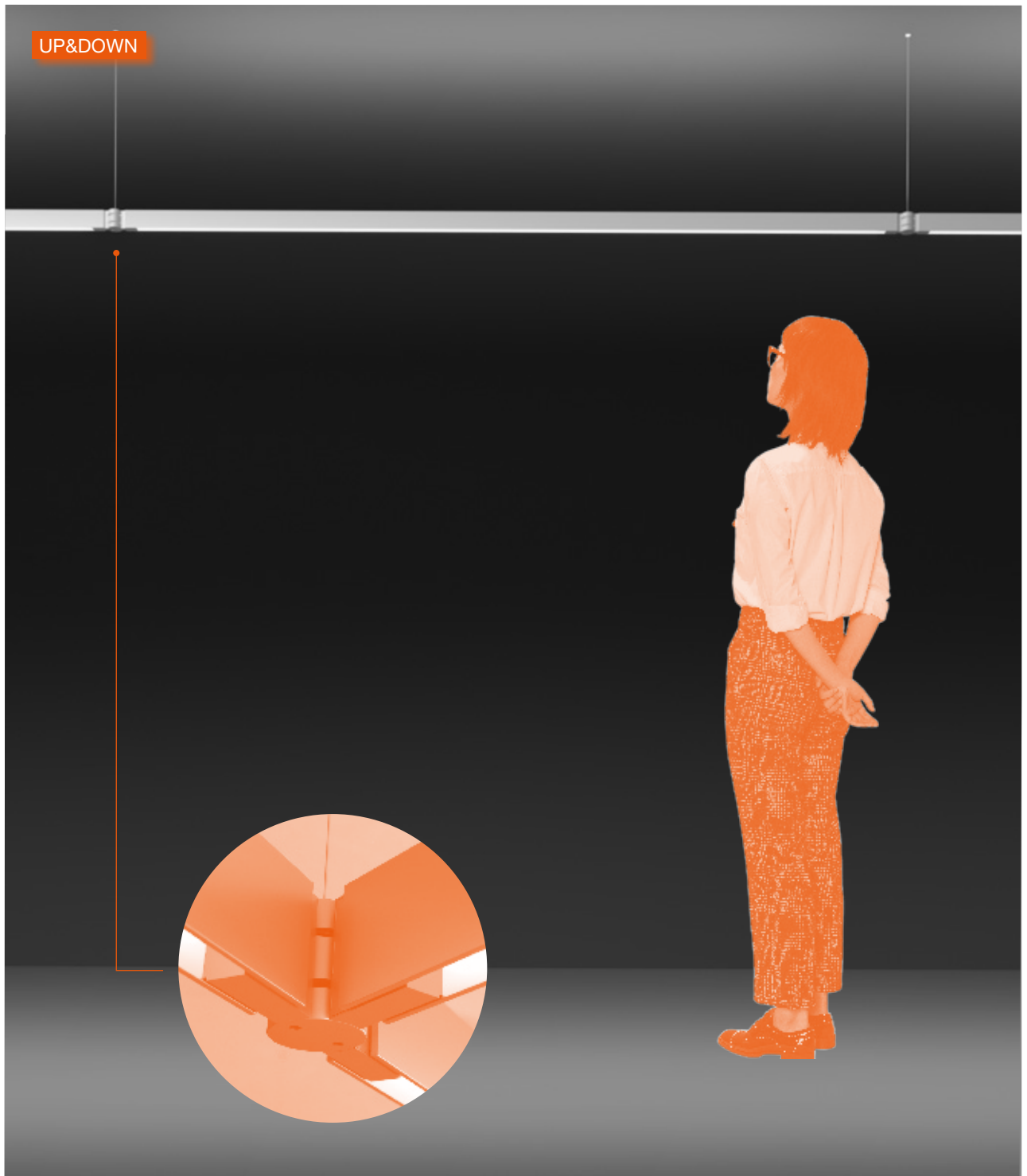

Diversion est disponible dans une gamme professionnelle complète avec deux profilés différents permettant une émission de lumière directe ou directe/indirecte. La longueur maximale disponible pour un seul profilé est de 2500 mm. Les deux versions peuvent aussi combiner l'éclairage d'accentuation grâce à une solution spécifique permettant d'intégrer jusqu'à deux spots Atom.

Diversion is available in a complete professional range including two different profiles that feature direct emission or direct/indirect emission. Maximum length available for a single profile is 2500 mm. Both versions can also combine accent lighting thanks to a dedicated solution allowing to integrate up to two Atom spots.

PROFILES + SPOTS

2500 mm



2000 mm



1500 mm



1000 mm



PROFILES

2500 mm



2000 mm

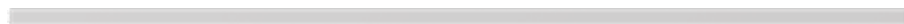

1500 mm



1000 mm



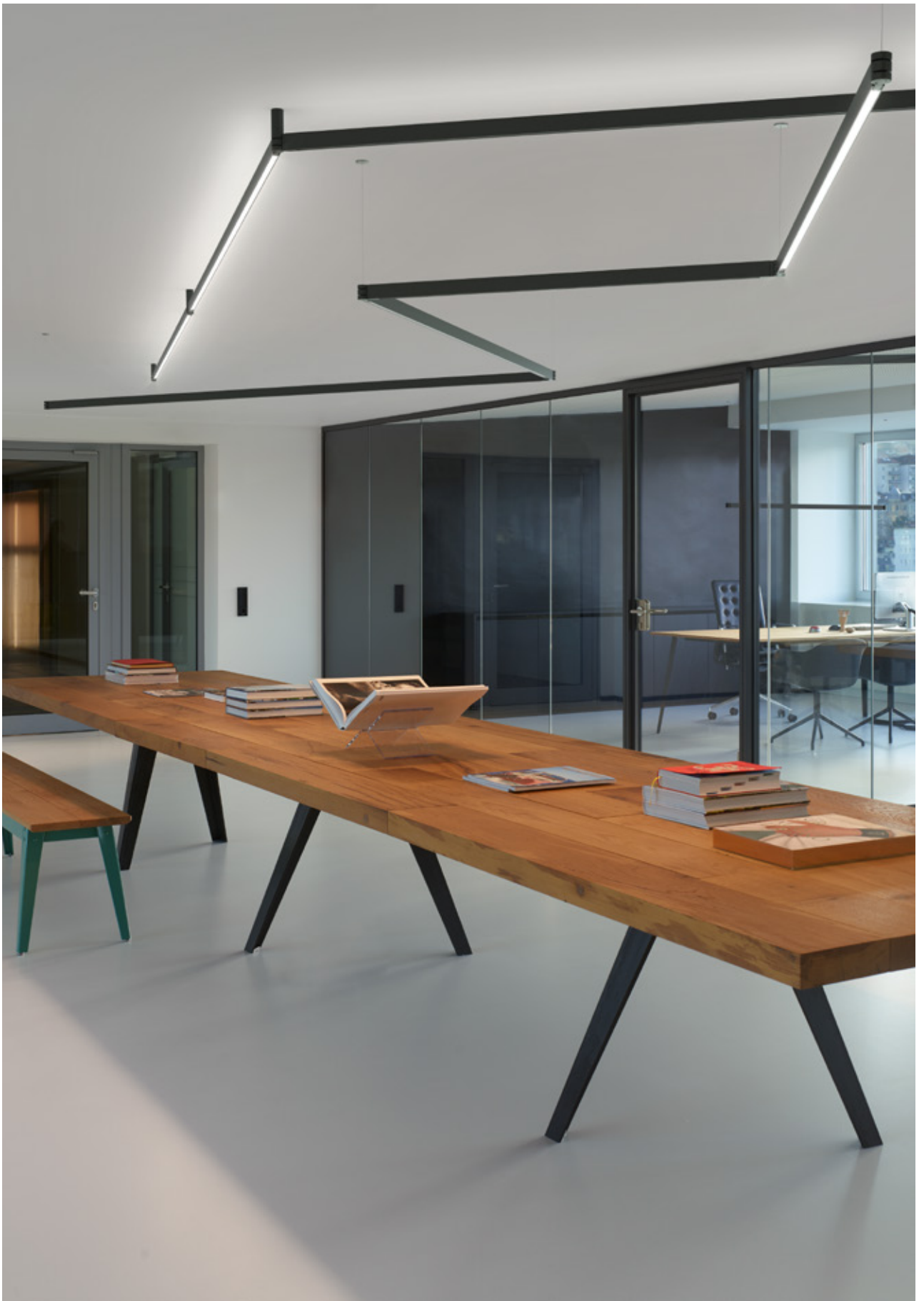



CONFIGURATION

Pratiquement toutes les configurations sont possibles grâce à l'adaptabilité du système. Des compositions purement géométriques jusqu'aux formes libres, en passant par la combinaison des modules Surfaces et Suspension pour obtenir une configuration 3D remarquable.

CONFIGURATION

Almost any kind of layout is achievable thanks to the versatility of the system. From pure geometric compositions up to free shapes, combining both Surface and Suspension modules to obtain an eye-catching 3D configuration.

EXAMPLE NO.1

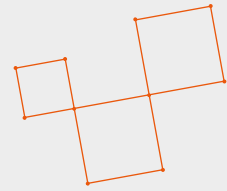

8 x Suspension Profile 1500mm
4 x Suspension Profile 1000mm

EXAMPLE NO.2

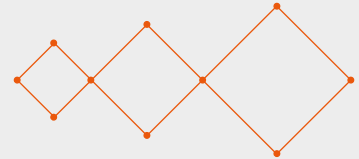

4 x Suspension Profile 2000mm
4 x Suspension Profile 1500mm
4 x Suspension Profile 1000mm

EXAMPLE NO.3

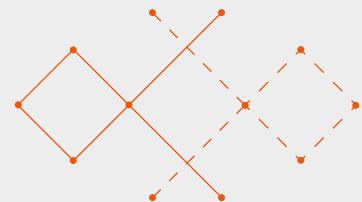

1 x Suspension Profile 2500mm
2 x Suspension Profile 1000mm
1 x Surface Profile 2000mm
2 x Surface Profile 1500mm
1 x Surface Profile 1000mm

EXAMPLE NO.4

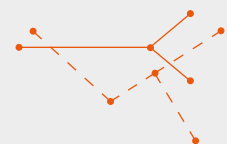

2 x Suspension Profile 2500mm
4 x Suspension Profile 1500mm
2 x Surface Profile 2500mm
4 x Surface Profile 1500mm

Suspension version ———

Surface version - - - - -



Tous les profilés Diversion pouvant intégrer la lumière d'accentuation peuvent recevoir jusqu'à deux projecteurs Atom. La lumière d'accentuation dispose d'un positionnement fixe à l'intérieur du profilé pour équilibrer la structure et assurer un nettoyage visuel maximal sur toutes les configurations.

All Diversion profiles preset to integrate accent lighting allow to install up to two Atom projectors. Accent lighting has a fixed positioning within the profile to balance the structure and assure maximum visual cleaning in all configurations.





	Différentes options de contrôle pour la régulation du Diversion, toutes disponibles pour une installation intégrée ou en surface.	Different control options for dimming Diversion, all available for remote recessed or surface installation.
PUSH DIMMING	Contrôle de la piste à travers un dispositif de régulation.	Control trough a simple pushbutton.
DALI	Protocole standard pour l'intégration avec tout système de contrôle.	Standard protocol for integration with any control system.
1-10V	Contrôle de la piste à travers un dispositif de régulation.	Track control trough a dimmer device.
CASAMBI	Contrôle sans fil de la piste via l'application FLOS Control®, disponible pour les appareils iOS et Android.	Track wireless control trough the FLOS Control® app, available iOS and Android devices.

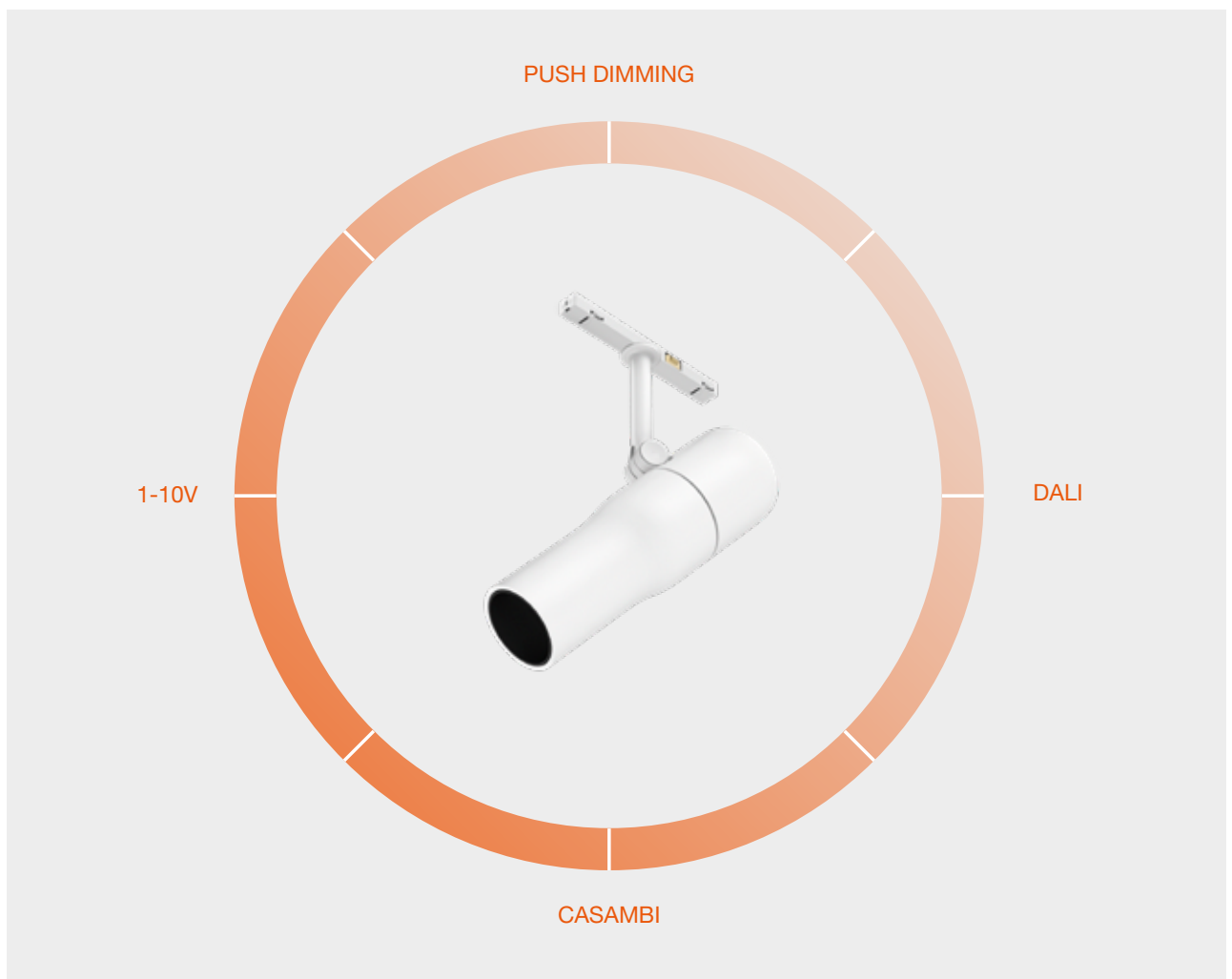

LIGHT MODULES STRUCTURES

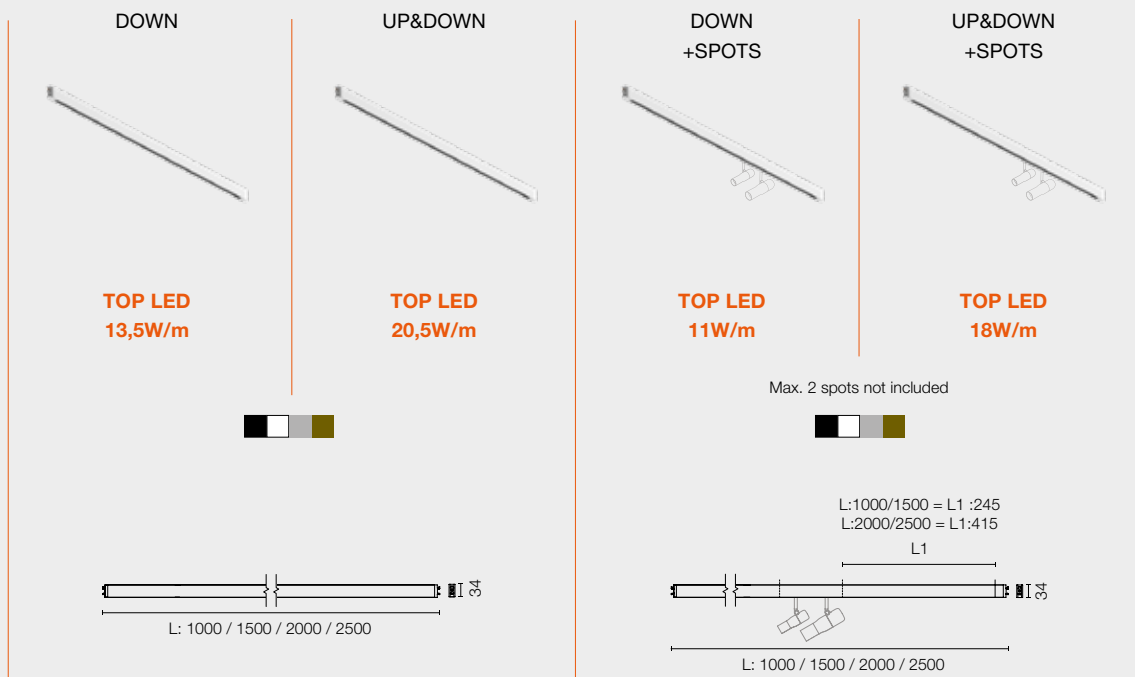

LIGHT MODULES

ATOM 90



POWER LED
5,5W

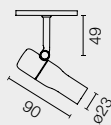

ATOM 120



POWER LED
8W

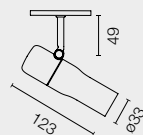

Spot



Medium

LIGHT MODULES

□ 40 Blanc
40 White

■ 1A Anodic Ice
1A Anodic Ice

■ 14 Noir
14 Black

■ CZ Bronze
CZ Bronze



FLOS
CONTROL BY CASAMBI



ZERO TRACK

ZERO TRAC

ZERO TRA

ZERO TR

ZERO T

ZERO

ZER

ZE

Z

Système de grille à basse tension (24 V) pour une mise en œuvre en surface qui, grâce à sa miniaturisation et sa simplicité géométrique, génère l'effet visuel d'affleurer le plafond/mur. Zero Track & Pro facilite l'application d'une structure superficielle avec l'élégance esthétique d'une installation encastrée.

Surface low voltage (24V) profile with a sleek, streamlined design to create a visual-flush solution for walls and ceilings. Zero Track & Pro combines the easy application of a surface structure with the sleek elegance of a flush installation.

ZERO TRACK & PRO





Restaurant Hert, Belgium





1. Blind End
2. Linear Conector Feed
3. Staight Connector
4. X Connector Feed
5. 90° Corner Feed
6. T Connector Feed
7. Power Supply Surface End
8. Power Supply Surface Middle
9. Inner Corner
10. Live End Feed

L'intégration parfaite avec l'architecture réalisée par Zero Track & Pro permet également une grande polyvalence des parcours et des lignes avec ses joints en forme de T, X, L et ses angles intérieurs dièdres pour les changements de plan plafond-mur, mur-mur et inversement.

Perfect integration with the Zero Track & Pro architecture also enables considerable versatility with tracks and lines with T, X and L joints, plus interior angles for ceiling-wall and wall-wall plane variations.

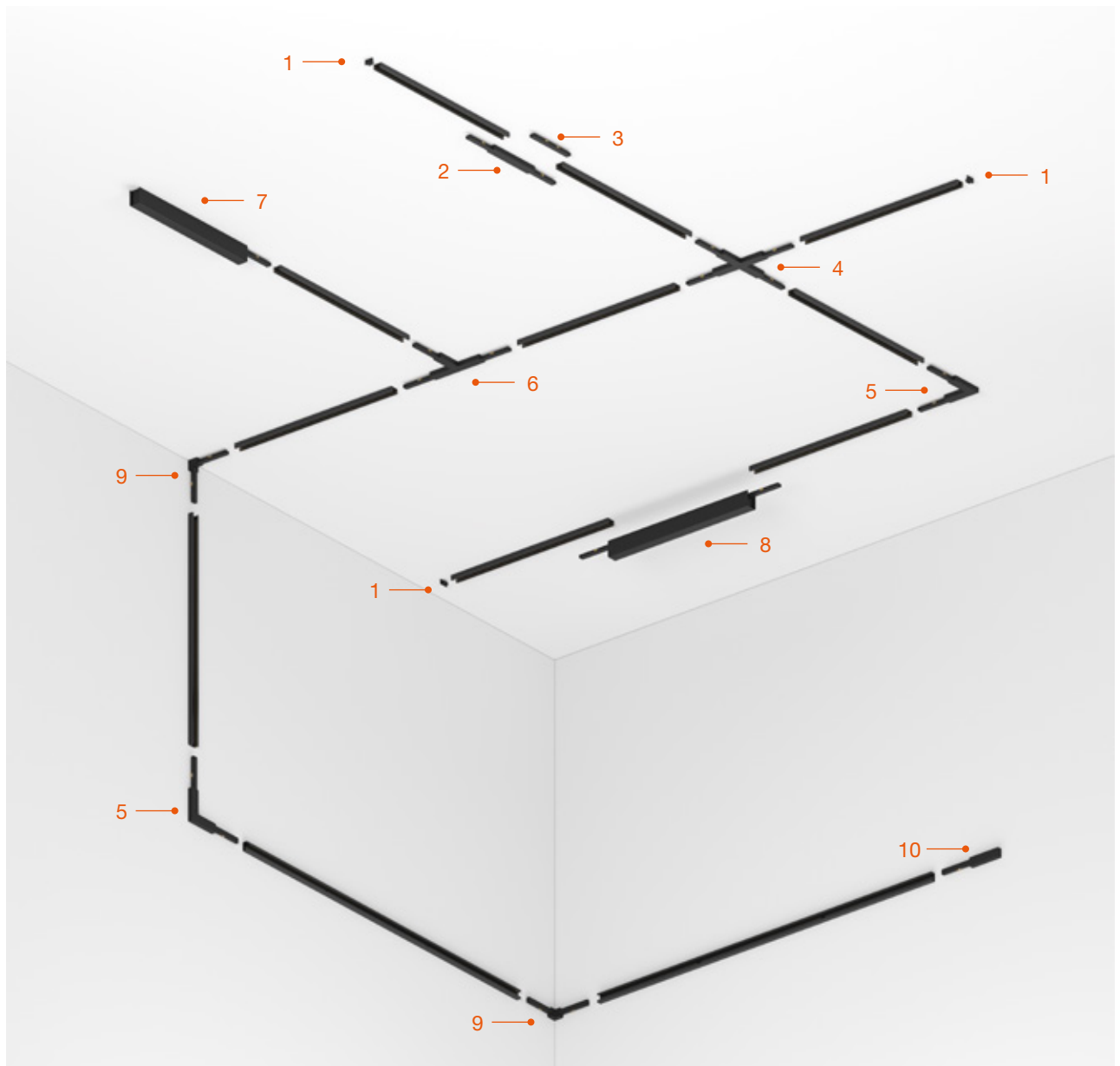





Les dimensions de Zero Track & Pro signifient que, visuellement, sa tridimensionnalité est presque invisible à la distance normale à laquelle on observe ce type de produit une fois installé. Ainsi, Zero Track & Pro est, esthétiquement, un profil d'apparence sans garniture.

The dimensions of Zero Track & Pro ensure that visually its three-dimensionality is almost not perceived at the normal distance at which this type of product is installed. The Zero Track & Pro solution therefore looks like a trimless profile.

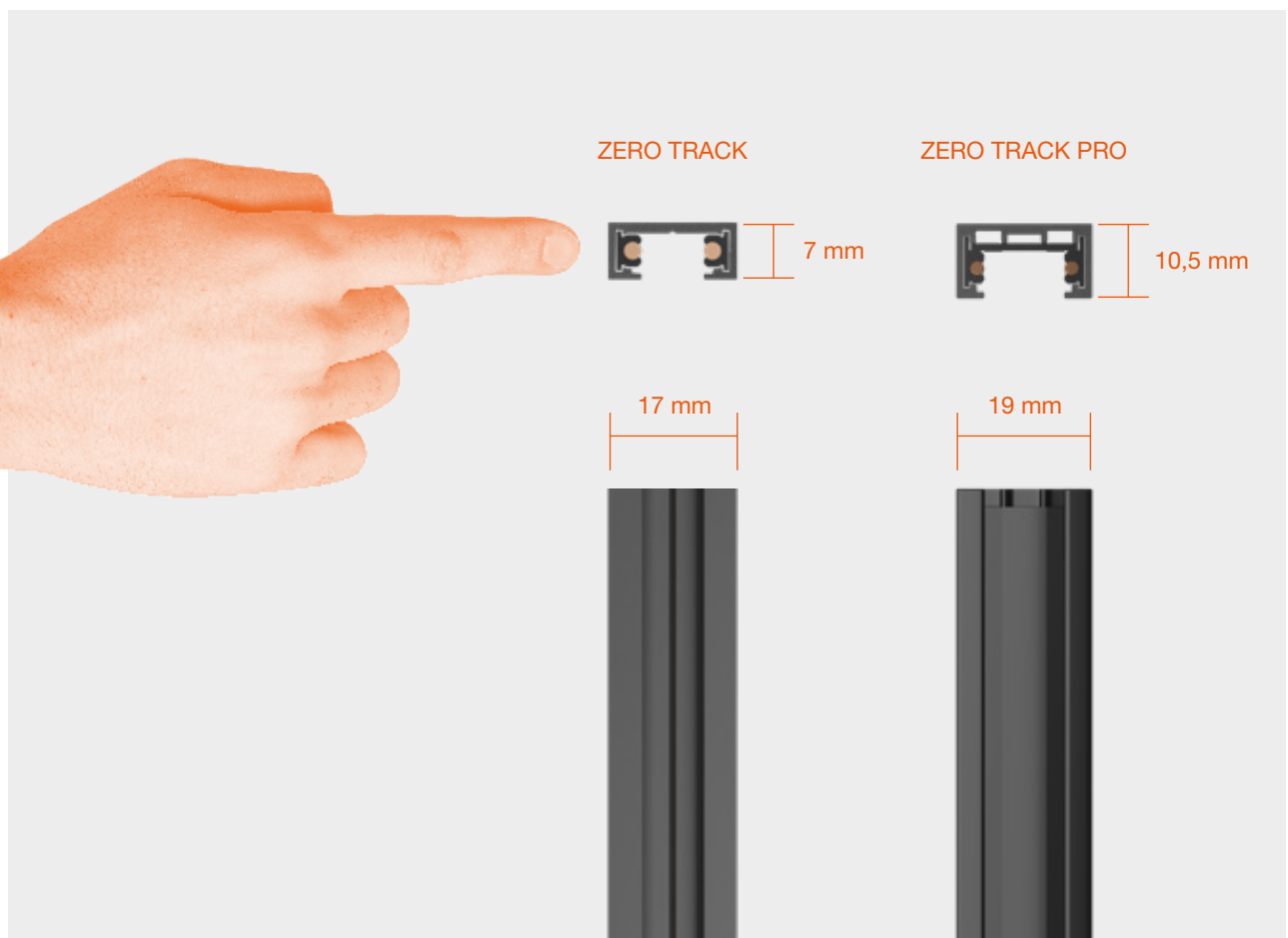



ZERO TRACK & PRO SYSTEM



1 BUS* pour la transmission des données.
Data transmission BUS*.

2 Conducteurs électriques basse tension.
Low voltage electric conductors.

3 Électronique de commande sans fil Casambi,
intégrée au luminaire. (* Consulter les modèles).
Casambi wireless control electronics, incorpo-
rated in the light. (* See models).

Zero Track Pro possède dans sa minuscule section des conducteurs électriques et des BUS* pour la transmission de données. Cela en fait une solution compatible avec les systèmes de contrôle les plus exigeants pour gérer les luminaires individuellement (point à point), soit sous le protocole DALI*, soit via le contrôle sans fil Casambi. De même, la gestion de diffusion 1-10 V* est possible.

Zero Track Pro features a small section with electric conductors and data transmission BUS*. The result is a compact solution with the most selective control system for managing lights individually (point to point) via DALI* protocol or wireless Casambi control. Similarly, 1-10V* broadcast control is possible.

TRADITIONAL SYSTEM

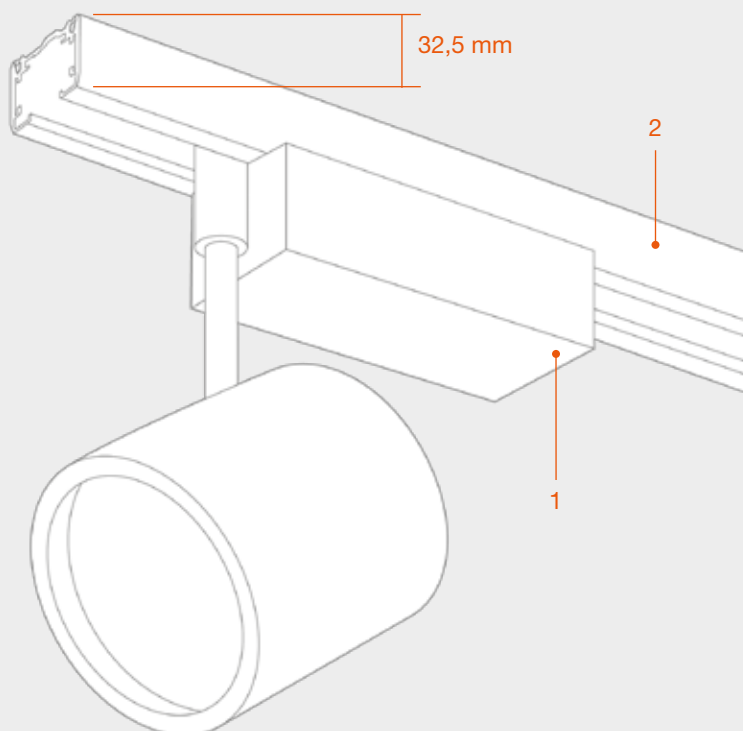

1 Moteur Traditionnel
Traditional Engine

2 Track Traditionnel
Traditional Track

En plus de l'option d'alimentation avec équipement à distance, Zero Track & Pro peut également alimenter le système à partir d'un équipement de surface à côté du rail, grâce au « Boîtier d'alimentation de surface » qui est proposé en accessoire.

In addition to the remote power supply option, Zero Track & Pro features an alternative with the system powered from a surface power supply box offered as an accessory.







FIND ME



La gamme de luminaires Zero Track & Pro comprend les spots Find Me, conçus par Jorge Herrera. Ce design innovant couvre trois tailles différentes, y compris le nouveau Find Me 0, qui fournit les designs les plus minimalistes de la collection Find Me.

The Zero Track & Pro luminaire range includes the Find Me spots designed by Jorge Herrera. This innovative design embraces three different sizes, including the new Find Me 0, which brings the minimal designs of the successful Find Me collection.

ATOM



Avec l'excellente touche design de Piero Lissoni, le système Zero Track & Pro propose la série Atom : des spots de trois tailles différentes, parfaits pour l'éclairage d'accentuation. Le système Zero Track & Pro offre le plus haut niveau de confort grâce à la position profonde de l'optique et des accessoires de filtrage inclus dans chaque spot, complétés par un luminaire de forme ronde pour un éclairage plus général.

With the exquisite design touch of Piero Lissoni, the Zero Track & Pro system offers Atom: a series of spotlights in three different sizes, perfect for an accent lighting. The Zero Track & Pro system provides the highest comfort level thanks to the deep position of the optic and the screening accessories included with each spot, completed by a round shape luminaire for a general lighting.









La technologie de grand confort visuel et de lentilles à double focale de la famille Light Shadow est également présente dans Zero Track Pro avec les tailles 30 et 45 de Light Shadow Spot.

The visual high-comfort technology and dual-focus lenses in the Light Shadow range are also available with Zero Track Pro Light Shadow Spot 30 and 45.



Avec Magic Stick, conçus par Jorge Herrera, et les lignes de lumière (qui sont intégrées à l'intérieur de Zero Track Pro), on obtient un éclairage général diffus et il est possible de créer des effets « d'éclairage graphique ».

With Magic Stick, designed by Jorge Herrera, and lines of light (incorporated in Zero Track Pro) general diffuse lighting can be achieved, in addition to graphic lighting effects.

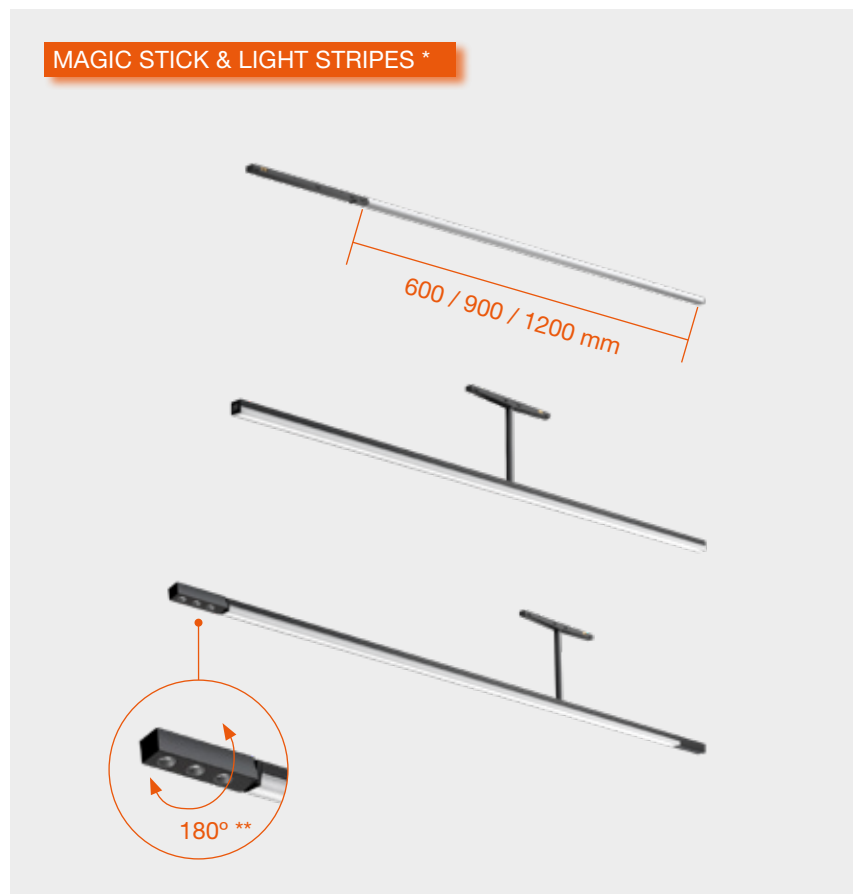

** Ensemble intégré de trois spots.
Éclairage inclinable et d'accentuation.

** Integrated three-spot set.
Accent lighting and tilting.

* Uniquement Zero Track Pro / * Only Zero Track Pro



Merci à Magic Stick, Zero Track Pro offre une expérience unique qui transforme n'importe quel espace, grâce à sa capacité à créer des compositions visuelles audacieuses et incomparables. Les exemples présentés ne représentent que quelques-unes de ses multiples possibilités.

Thanks to Magic Stick, Zero Track Pro provides a unique experience that transforms any space, through its ability to create bold and unparalleled visual compositions. The examples presented only represent some of its many possibilities.

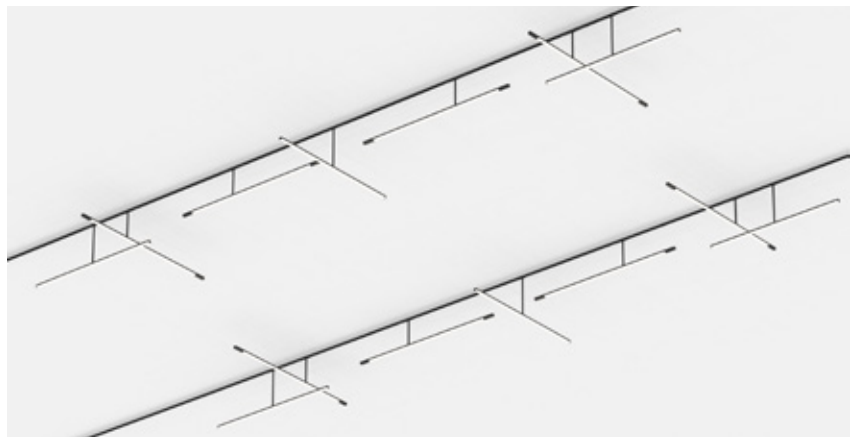

	Différentes options de contrôle pour la régulation du Zero Track & Pro, toutes disponibles pour une installation intégrée ou en surface.	Different control options for dimming the Zero Track & Pro, all available for remote recessed or surface installation.
DALI *	Protocole standard pour l'intégration avec tout système de contrôle.	Standard protocol for integration with any control system.
1-10V BROADCAST *	Contrôle de la piste à travers un dispositif de régulation.	Track control through a dimmer device.
CASAMBI	Contrôle sans fil de la piste via l'application FLOS Control®, disponible pour les appareils iOS et Android.	Track wireless control through the FLOS Control®, available iOS and Android devices.

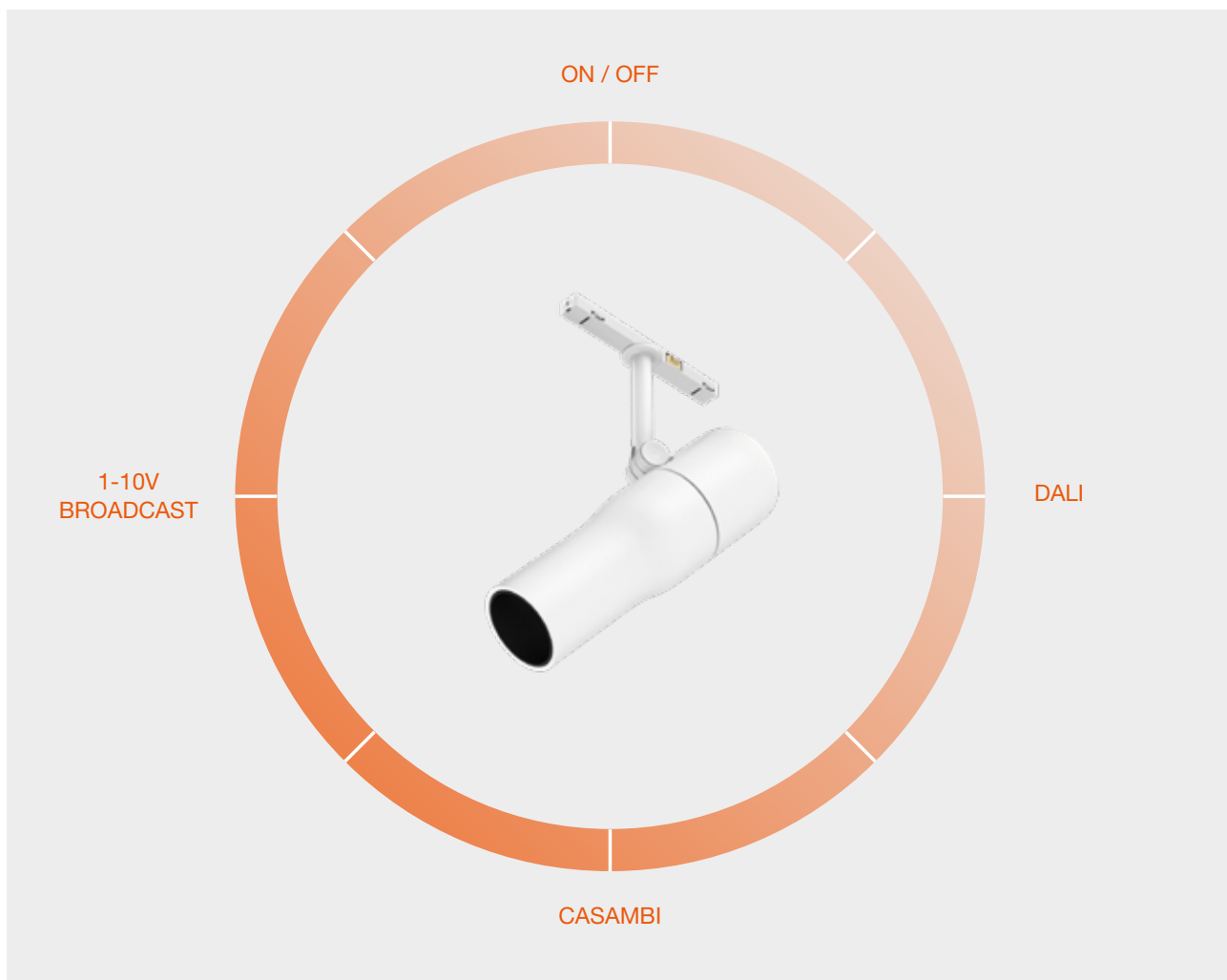



LIGHT MODULES

LIGHT STRIPE
600 / 900 / 1200



TOP LED
Up to 13,5W



MAGIC STICK



POWER LED
10,5W

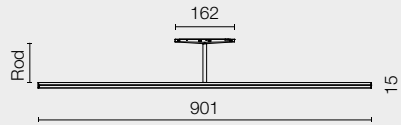

Rod: 100 / 145 / Custom

MAGIC STICK
ASYMMETRIC



POWER LED
12W

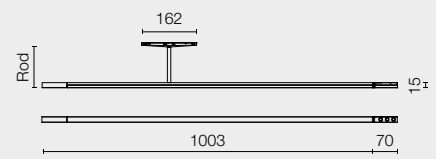

Rod: 100 / 145 / Custom

FIND ME 0



POWER LED
3,5W

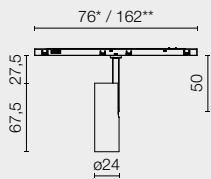

FIND ME 1



POWER LED
5,5W

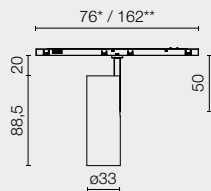

FIND ME 2



POWER LED
10,5W

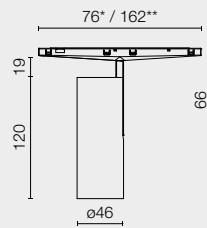

FIND ME 1
SUSPENSION



POWER LED
5,5W

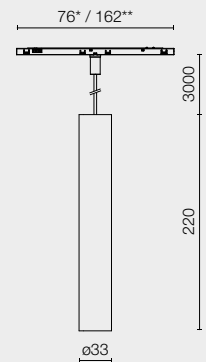

* Non Dimmable, Casambi / ** Dali, 1-10V



Spot



Medium



Flood



Wide Flood

LIGHT MODULES

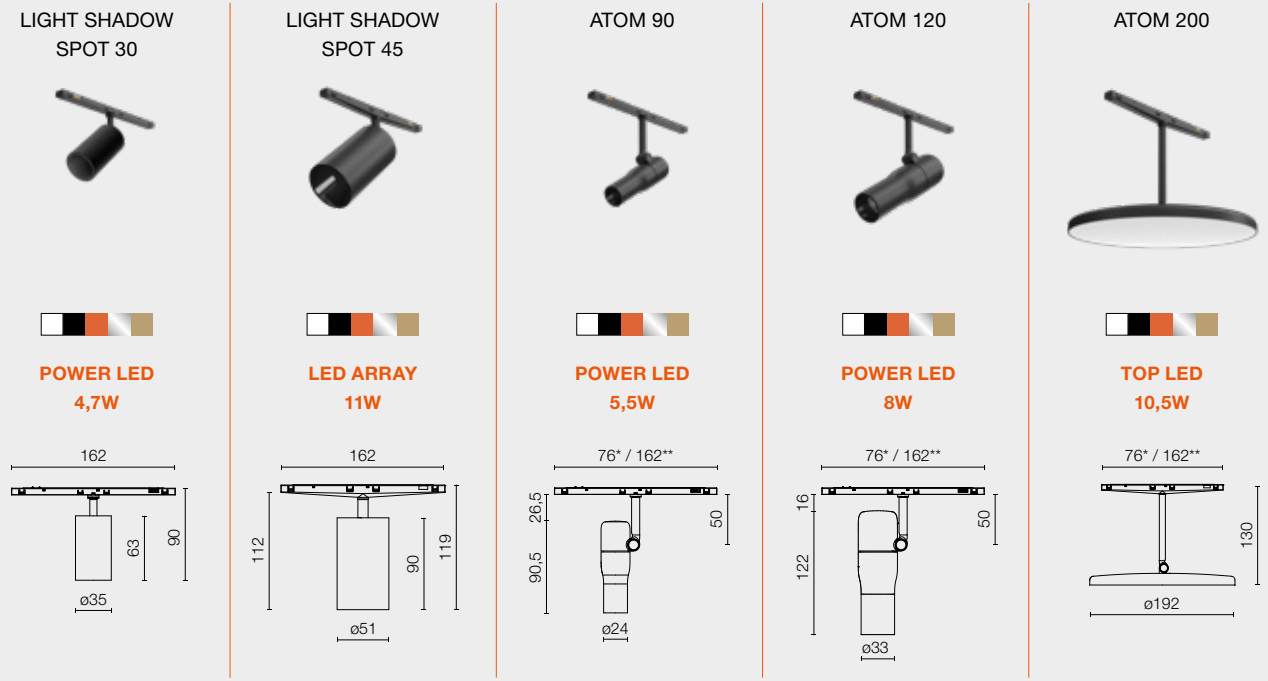

* Non Dimmable, Casambi / ** Dali, 1-10V

- 40 Blanc
40 White
- 14 Noir
14 Black
- EQ Cuivre Brossé*
EQ Brushed Copper*
- ER Acier Brossé*
ER Brushed Steel*
- ES Bronze Brossé*
ES Brushed Bronze*

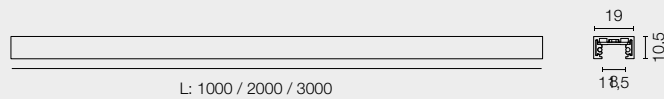

*Coming Soon - Metallic Colours

LIGHT MODULES

FIND ME 0



POWER LED
3,5W

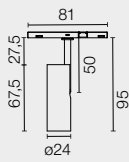

FIND ME 1



POWER LED
5,5W

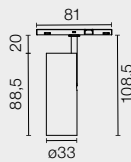

FIND ME 2



POWER LED
10,5W

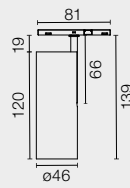

FIND ME 1
SUSPENSION



POWER LED
5,5W



ATOM 90

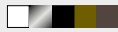

POWER LED
5,5W

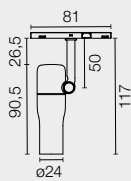

ATOM 120



POWER LED
8W

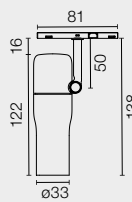

ATOM 200



POWER LED
10,5W

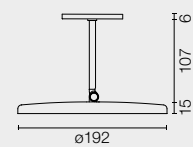

Spot



Medium



Flood

SURFACE PROFILES

□ 40 Blanc
40 White

◻ 06 Chromé
06 Chrome

■ 14 Noir
14 Black

■ CZ Bronze
CZ Bronze

■ 18 Deep brown
18 Deep brown

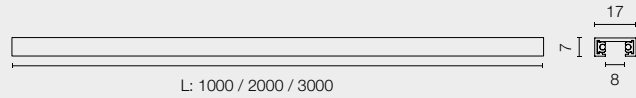

THE MICRO THE MICRO THE MICRO THE MICRO

RUNNING MAGNET

THE MICRO THE MICRO THE MICRO THE MICRO

RUNNING MAGNET

THE MICRO THE MICRO THE MICRO THE MICRO

RUNNING MAGNET

THE MICRO THE MICRO THE MICRO THE MICRO

RUNNING MAGNET

THE MICRO THE MICRO THE MICRO THE MICRO

RUNNING MAGNET

THE MICRO THE MICRO THE MICRO THE MICRO

RUNNING MAGNET

THE MICRO THE MICRO THE MICRO THE MICRO

RUNNING MAGNET

THE MICRO THE MICRO THE MICRO THE MICRO

RUNNING MAGNET

Programme innovant de structures ultra-miniaturisées en version encastrée et de surface. Compatible avec un vaste ensemble de solutions d'éclairage professionnel par fixation magnétique. La solution ultime pour l'éclairage d'expositions.

Innovative program of ultra-miniaturized structures in recessed and surface versions. Compatible with a wide range of professional lighting solutions by means of magnetic fixing. The ultimate solution for exhibition lighting.

THE MICRO RUNNING MAGNET







La quintessence de la lumière intégrée, obtenue grâce à un profilé de seulement 5 mm qui permet l'intégration totale de microdispositifs conçus pour être combinés avec la structure jusqu'à sa quasi-disparition.

The quintessence of integrated light, obtained thanks to a profile of only 5 mm that allows the total integration of micro-devices designed to be combined with the structure until they disappear almost completely.



1 RECESSED

2 SURFACE



La taille incroyablement petite du profilé qui caractérise le programme met en valeur la flexibilité de la lumière et sa relation avec l'architecture. Les corps d'éclairage sont installés au moyen d'un support magnétique situé à l'intérieur du profilé pour une facilité d'utilisation inégalée.

The incredibly small profile size that characterizes the program enhances the light's flexibility and its relationship with the architecture. The lighting bodies are installed by means of a magnetic support inside the profile, providing an unparalleled ease of use.

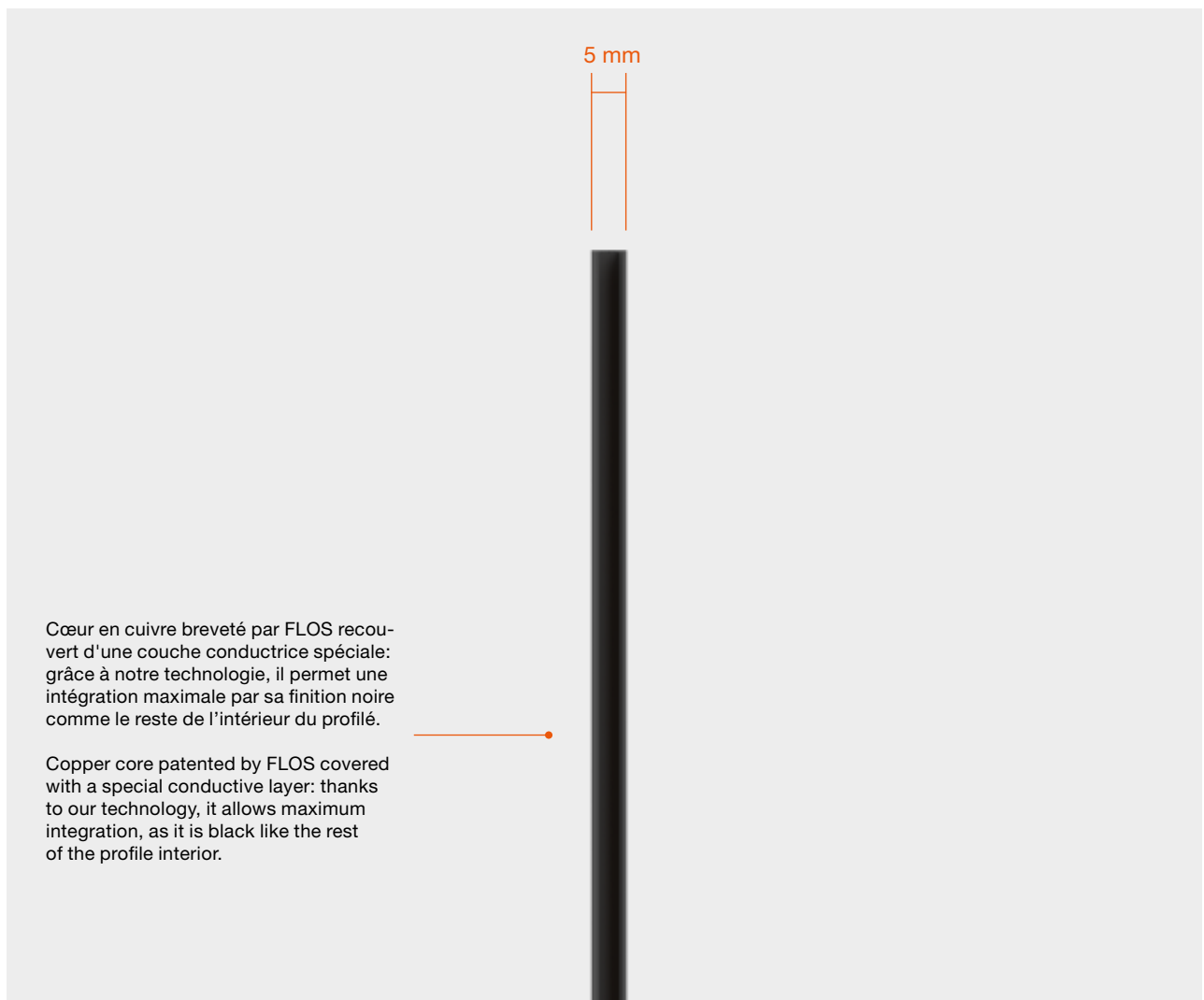



Sergio Rossi, London



La fixation magnétique des luminaires permet leur manipulation à chaud. Les corps d'éclairage peuvent être déplacés lorsqu'ils sont allumés, ce qui permet d'obtenir une grande flexibilité et une adaptabilité de la configuration à tout moment.

Magnetic fixing of the luminaries, which allows hot handling. The lighting bodies can be moved when they are still on, achieving enormous flexibility and adaptability in the configuration at any time.

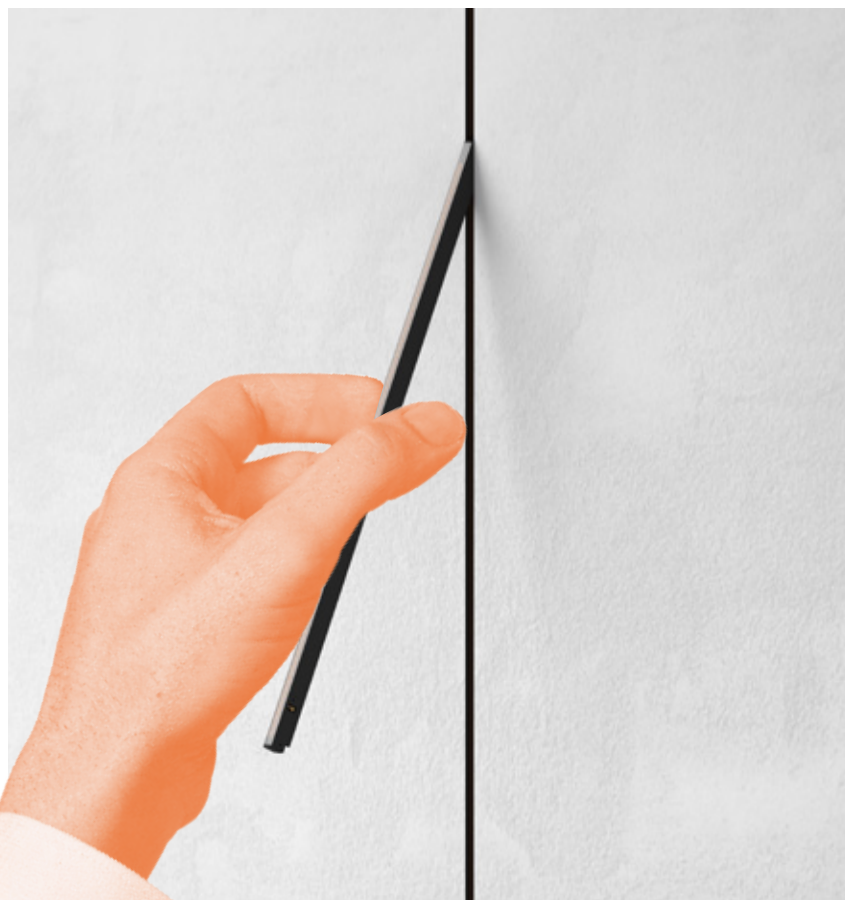







NANO SPOT

Avec un diamètre de seulement 12 mm, cet incroyable projecteur garantit des valeurs de haute intensité et permet de trouver facilement une solution pour les focalisations les plus complexes tout en restant invisible même à courte distance.

With a diameter of only 12 mm, this incredible projector guarantees high intensity values and allows you to easily resolve the most complex focal points while remaining invisible even from short distances.



SPOT MODULES

Gamme complète de microprojecteurs disponibles dans des différentes puissances et tailles. Tous les modèles comprennent des microlentilles professionnelles stabilisées en acrylique pour un contrôle maximal des effets lumineux.

Complete range of micro-projectors available in various powers and sizes. They all include professional acrylic stabilized micro-lenses for a maximum control of lighting effects.



LIGHT SHADOW SPOT

Ce projecteur ultracompact utilise le même groupe optique que le Light Shadow. Source invisible, cut-off intégré pour une élégance formelle et un confort visuel inégalés.

This ultra-compact projector uses the same optical unit as Light Shadow. Invisible source, integrated cut-off for unparalleled visual comfort and formal elegance.

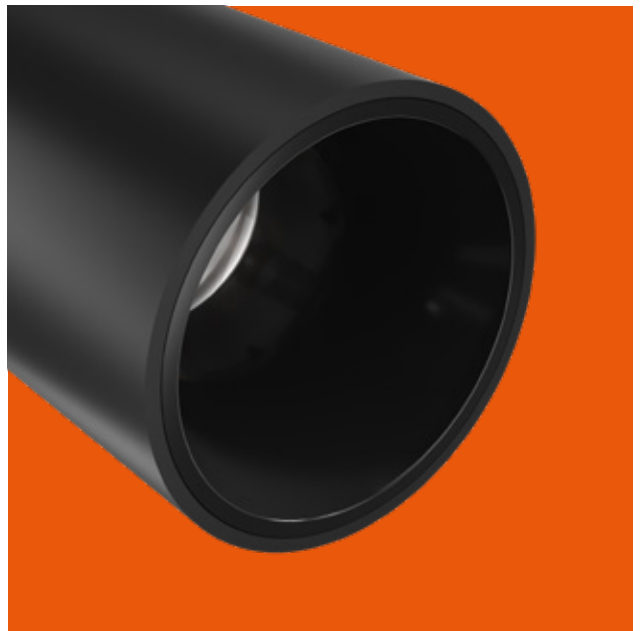

FIND ME

Projecteur d'éclairage intérieur avec source lumineuse LED, constituée d'un corps cylindrique qui, en position haute, fait office de downlight et, en position basse, devient un projecteur orientable.

Interior lighting projector with LED light source, consisting of a cylindrical body that acts as a downlight when set in its upper position and becomes an adjustable projector when set in its lower position.



LIGHT STRIPE DIFFUSED / WALL-WASHER

Profilé microlinéaire avec optique wall-washer miniature intégrée. La lentille spéciale brevetée émet un éclairage vertical extrêmement uniforme et enveloppant. Elle est idéale pour créer un arrière-plan lumineux doux et sans contrastes dans une niche d'exposition.

Linear micro-profile with an integrated miniature wall-washer optic. The special patented lens emits an extremely uniform and enveloping vertical lighting. It is ideal for creating a soft, non-contrasting light background within an exhibition niche.

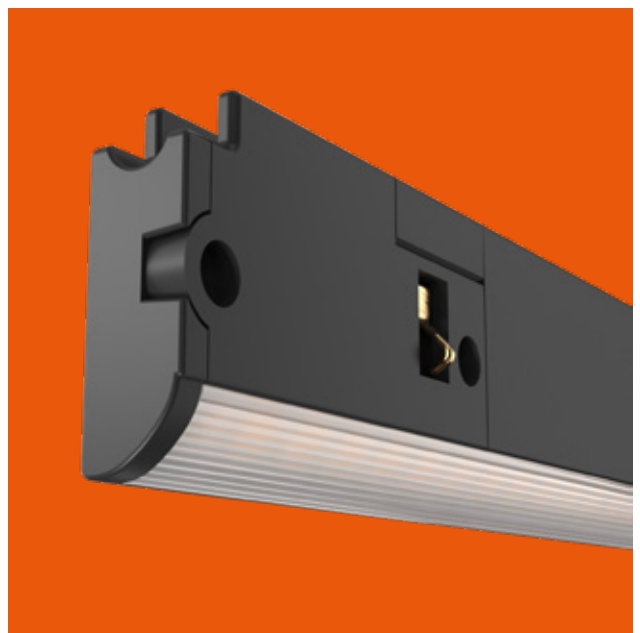

CONNECTIONS (RECESSED)

Le profilé encastré garantit un résultat final impeccable grâce aux bords latéraux spéciaux permettant de terminer l'installation avec des détails de haute qualité.

The recessed profile guarantees a flawless final result thanks to the special blocking sides that allow the installation to be finished with high-quality details.

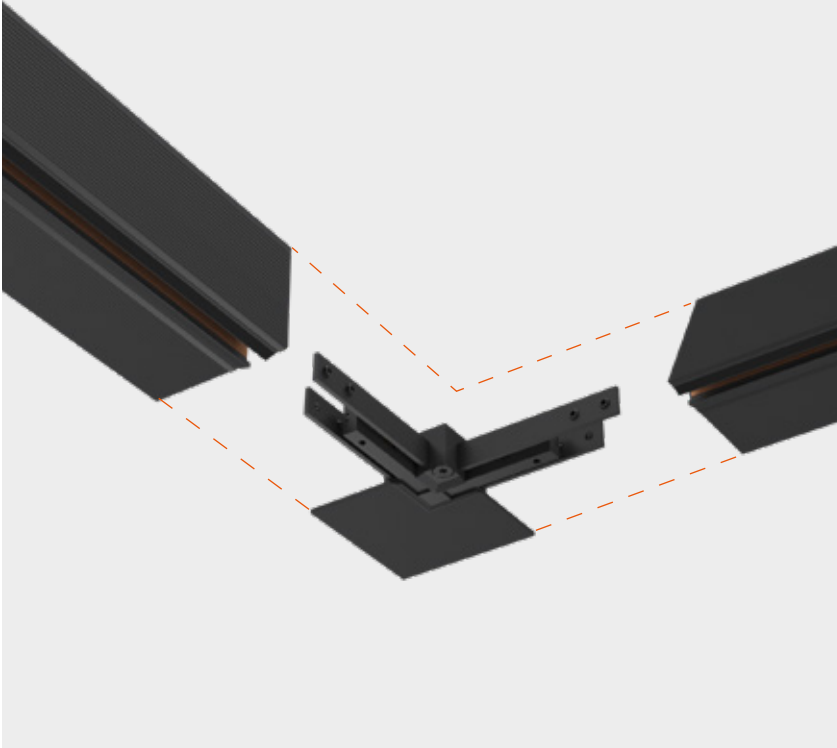

CONNECTIONS (SURFACE)

Installé en surface, le profilé est si petit qu'il disparaît de la vue, laissant seulement une ligne très fine qui traverse les pièces et permet de les distinguer avec des effets lumineux sophistiqués qui envahissent les murs, les plafonds, les couloirs et les vitrines.

Installed on the surface, the profile is so small that it disappears from the eye, becoming a very thin line that crosses the rooms and characterizes them with sophisticated lighting effects that invade walls, ceilings, corridors and showcases.





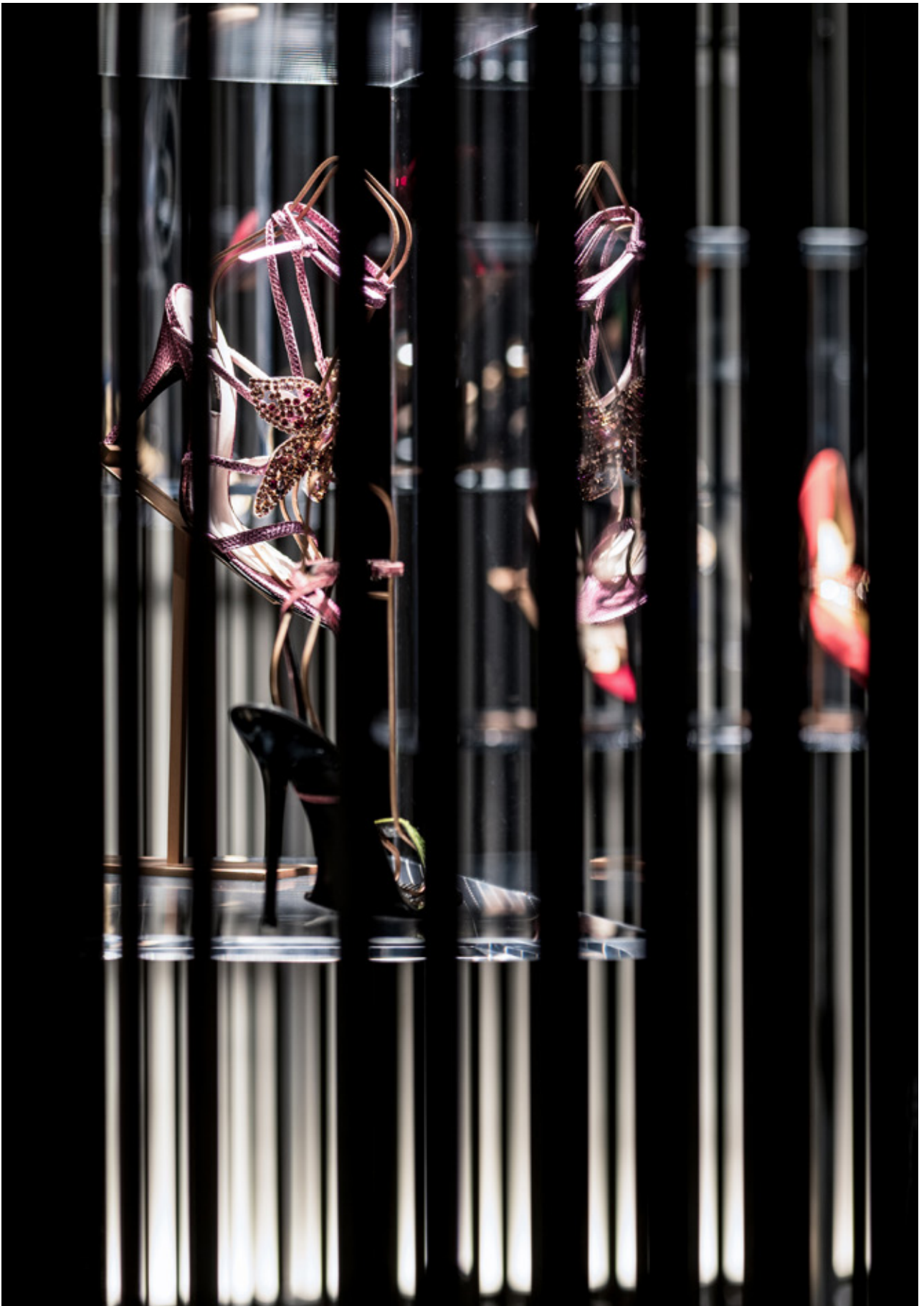

Sergio Rossi Showroom,
Milan



Sergio Rossi Showroom,
Milan

The Micro Running Magnet est la solution ultime pour l'éclairage d'expositions. Un programme complet et professionnel qui, en plus d'avoir des dimensions réduites, offre une lumière équilibrée et attractive pour mettre en valeur chaque objet de la meilleure façon possible et à 360°.

The Micro Running Magnet is the ultimate solution for exhibition lighting. A complete and professional program that, in addition to its reduced dimensions, provides a balanced and attractive light to highlight each object in the best way and in 360°.

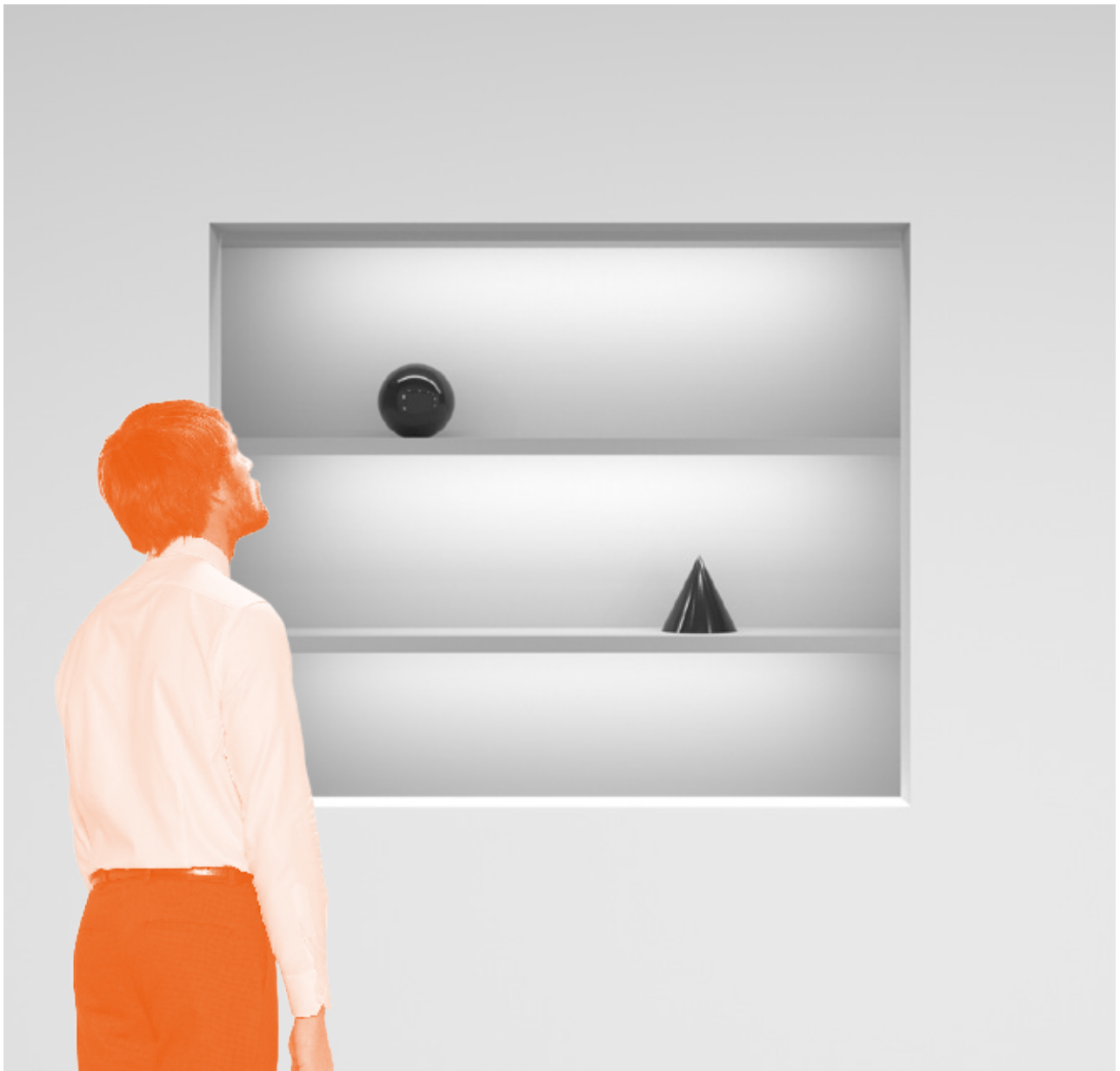

1 Microprojecteurs LED avec des solutions cut-off intégrées et des lentilles dédiées pour créer des contrastes et des accents lumineux.

LED micro-projectors with integrated cut-off solutions and dedicated lenses to create contrasts and light accents.

2 Profilé microlinéaire complet avec écran diffuseur opale pour des détails de lumière diffuse.

Complete linear micro-profile with opal diffuser screen for diffused light details.

3 Microprofil wall-washer linéaire avec lentille brevetée pour des effets lumineux asymétriques contrôlés.

Linear wall-washer micro-profile with patented lens for controlled asymmetric light effects.





New Kvadrat Soft Cells
Showroom, London

	Différentes options de contrôle peuvent être adaptées à n'importe quel besoin.	Different control options that can be adapted to any need.
DALI	Contrôle broadcast de chaque luminaire.	Broadcast control of each luminaire.
1-10V	Contrôle à distance en broadcasting (variation de tous les luminaires dans un seul groupe).	Broadcasting remote control (dimming of all the luminaires in a single group).
CASAMBI	Contrôle individuel et broadcast par application pour tablette ou smartphone (FLOS Control®).	Individual & Broadcast control through a tablet or smartphone application (FLOS Control®).

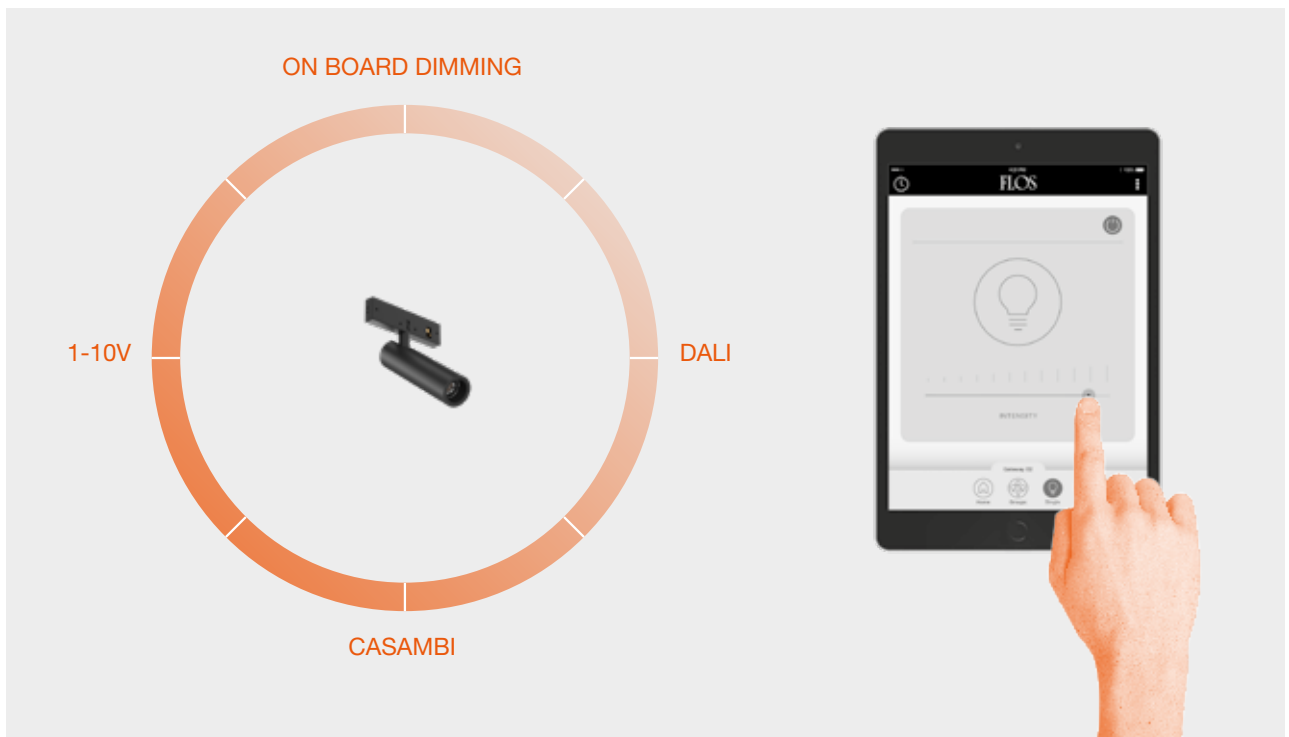

FLOS CONTROL® BY CASAMBI

L'application FLOS Control® permet de contrôler les appareils d'éclairage du système en contrôlant les scènes et la programmation.

Il suffit d'une installation électrique traditionnelle et du Gateway connecté par Bluetooth pour obtenir un contrôle total de l'espace.

Disponible pour IOS et Android

The FLOS Control® application allows you to control the system's luminaires controlling scenes and programming.

With a traditional electrical installation and the Gateway connected by Bluetooth, you obtain total control of the ambience.

Available for iOS and Android

FLOS
CONTROL BY CASAMBI





LIGHT MODULES

NANO SPOT

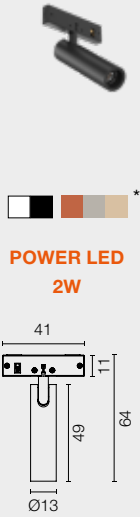

MICRO SPOT



SPOT



LIGHT SHADOW SPOT



FIND ME 0

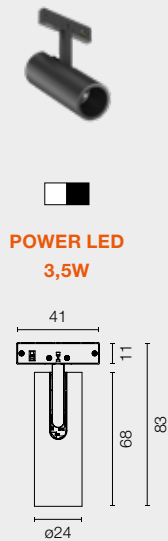

FIND ME 1



LIGHT STRIPE
DIFFUSED

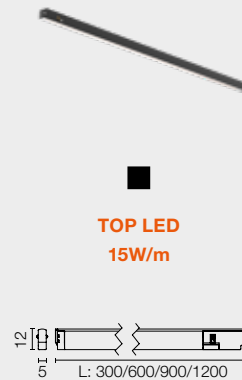

LIGHT STRIPE
WALL-WASHER

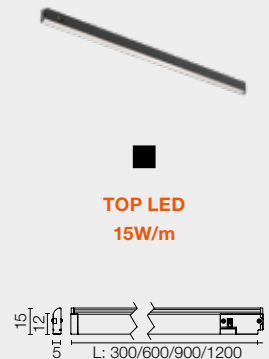

Spot



Medium



Flood



Wall-Washer



Diffused

RECESSED



■ 14 Noir
■ 14 Black

SURFACE



□ 40 Blanc
□ 40 White
■ 14 Noir
■ 14 Black

THE RUNNING

MAGNET

THE RUNNING

MAGNET

THE RUNNING

MAGNET

THE RUNNING

MAGNET

Programme de structures en versions encastrées, en surface et suspendues. Il accueille une large gamme de luminaires par fixation magnétique. Réglage et variation par protocoles universels et à travers l'application FLOS Control®.

Program of structures in recessed, surface and suspended versions. A wide range of light fixtures is housed inside it using magnetic fastening. Regulation and control with universal protocols and using the FLOS Control® application.

THE RUNNING MAGNET

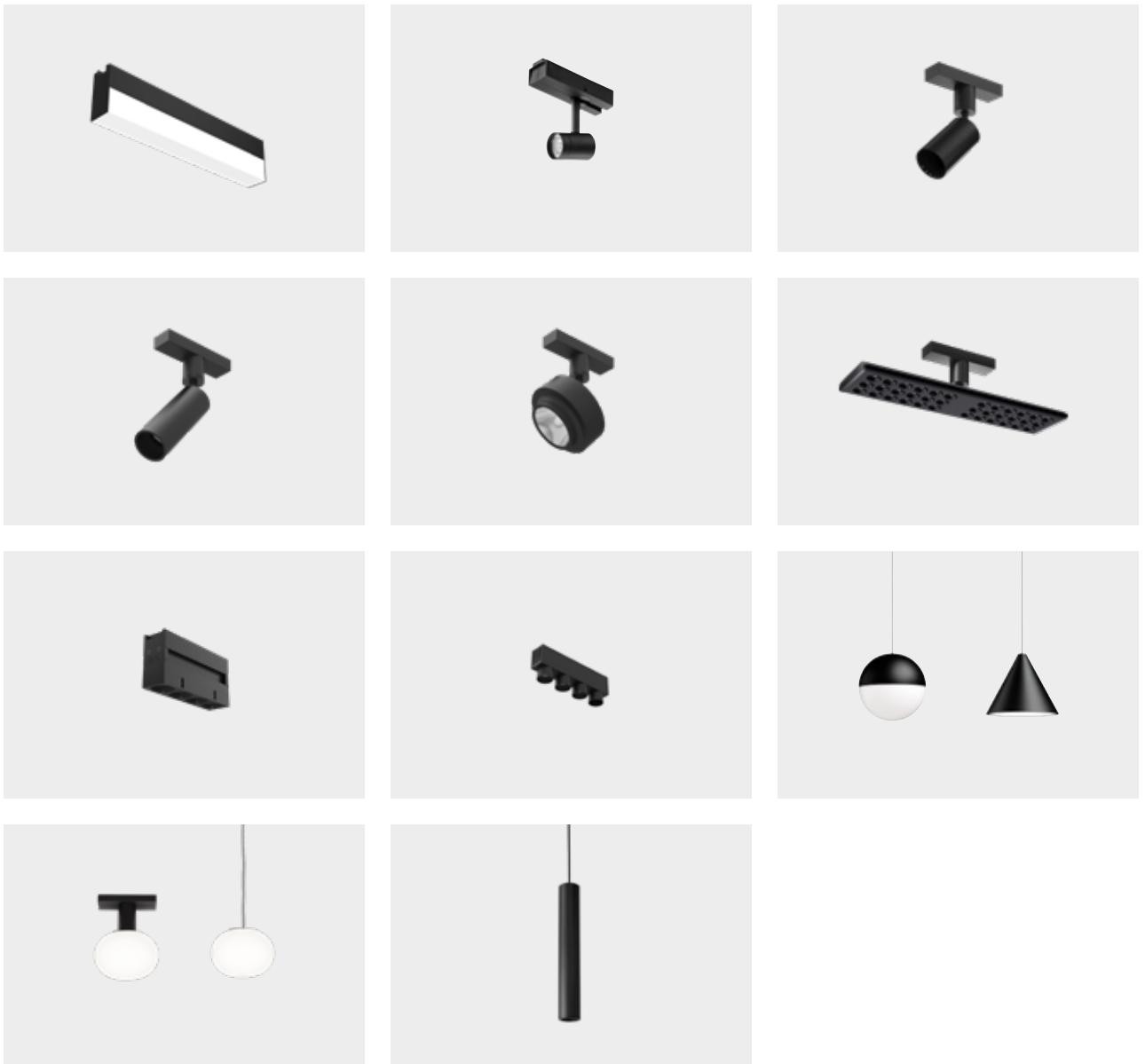





La gamme est composée de profilés magnétiques spéciaux, alimentés en 24V et sur lesquels sont placés les modules d'éclairage LED. Les profilés conviennent à une installation en surface, suspendue ou encastrée dans des murs ou des plafonds en placoplâtre. Le Running Magnet est complété par des modules d'éclairage d'ambiance et d'accentuation avec diverses optiques, ainsi que par une sélection d'accessoires d'éclairage décoratifs extraits et adaptés de la FLOS Home Collection.

The range consists of special 24V-powered magnetic profiles on which the LED lighting modules are placed. The profiles are suitable for surface, suspended or recessed installations in walls or plasterboard ceilings. The Running Magnet is completed by ambient and accent lighting modules with different optics, plus a selection of decorative lighting accessories originating and adapted from the FLOS Home Collection.



- 1 RECESSED
- 2 SURFACE
- 3 SUSPENSION DOWN
- 4 SUSPENSION UP&DOWN

4

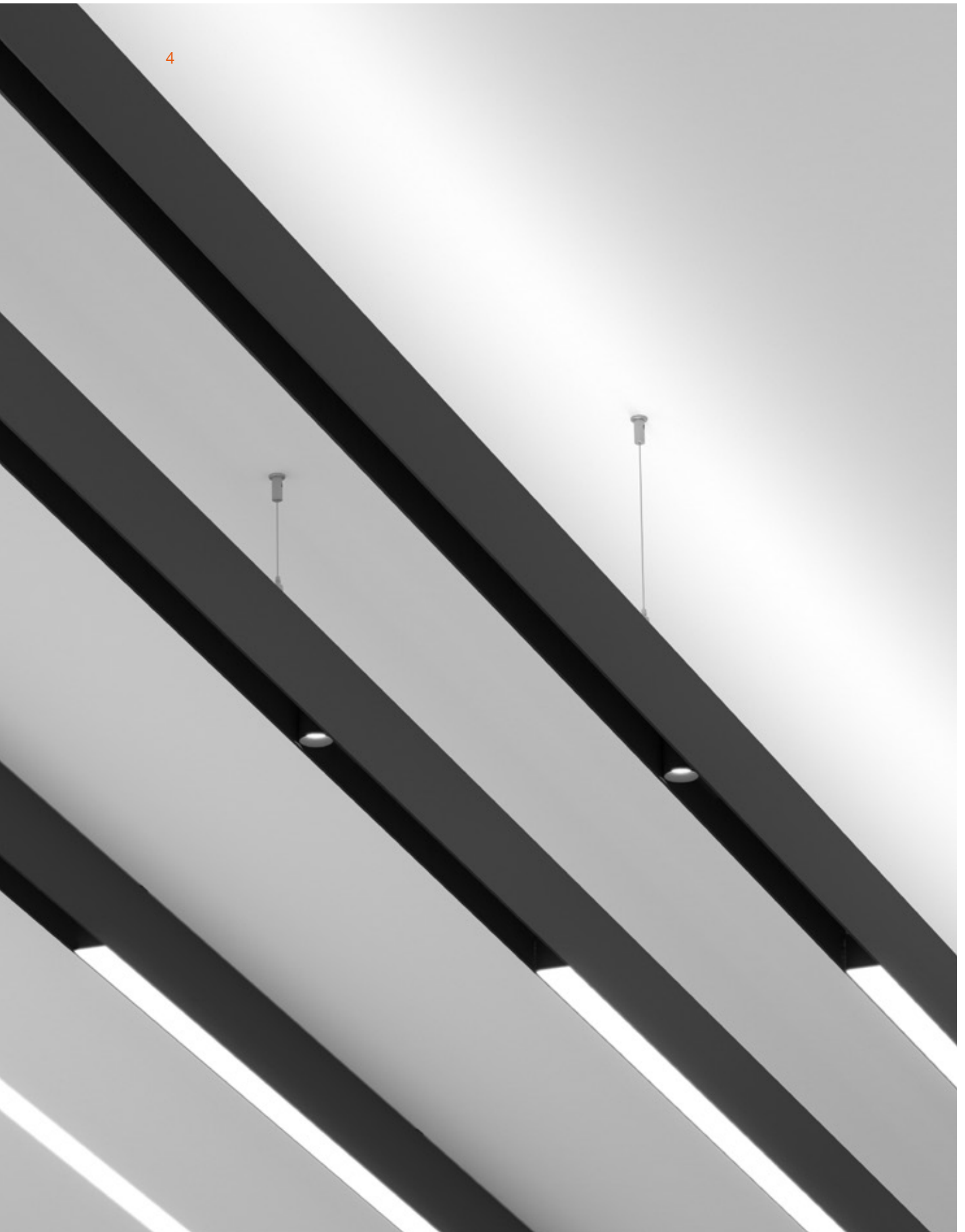





La solution pour une fusion totale avec l'architecture, réalisée grâce à l'intégration totale des luminaires qui disparaissent à l'intérieur des surfaces. Son installation magnétique simplifie la conception de l'éclairage dans l'espace. Compatible avec tous les principaux systèmes de variation et FLOS Control®.

The solution for a total fusion with architecture, achieved thanks to the total integration of luminaires that can disappear inside surfaces. Its magnetic installation offers super easy way to design the light in space. Compatible with all main control systems and FLOS Control®.

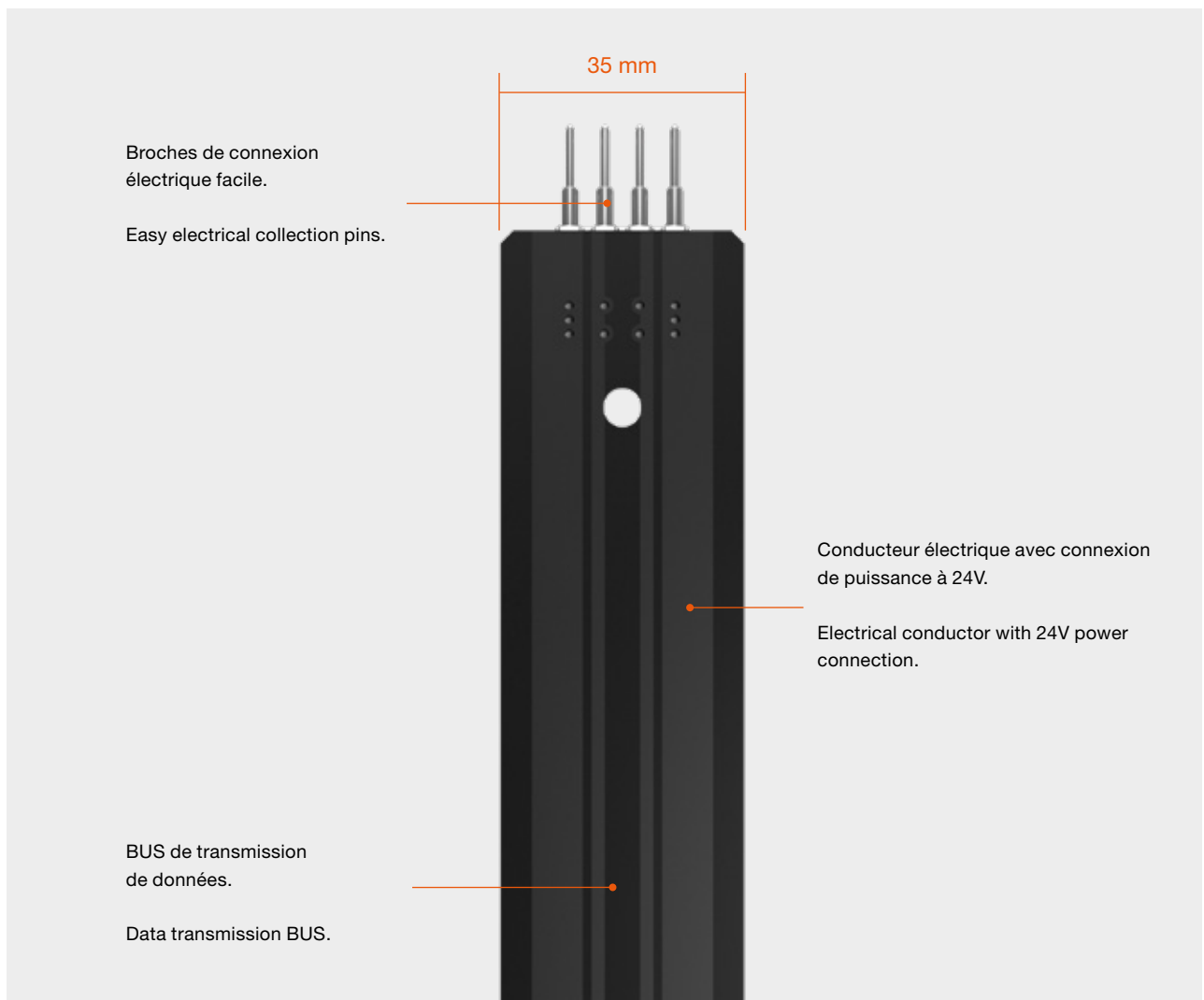



Boutek Offices, Italy







Fixation magnétique des luminaires qui permet de les manipuler même à chaud, de les déplacer lorsqu'ils sont allumés, offrant une flexibilité et une souplesse d'adaptation de la configuration à tout moment.

Magnetic fixing of the luminaires, which allows hot handling. They can be moved while they are still on, achieving enormous flexibility and adaptability in the configuration at any time.





Cassina + Siematic
Showroom, Japan

SPOT MODULE

Module spot avec lentille reculée pour un confort visuel optimal.

Spot module with far back positioned lens for optimal visual comfort.

1 Cylindre de blindage externe.
Exterior shield cylinder.

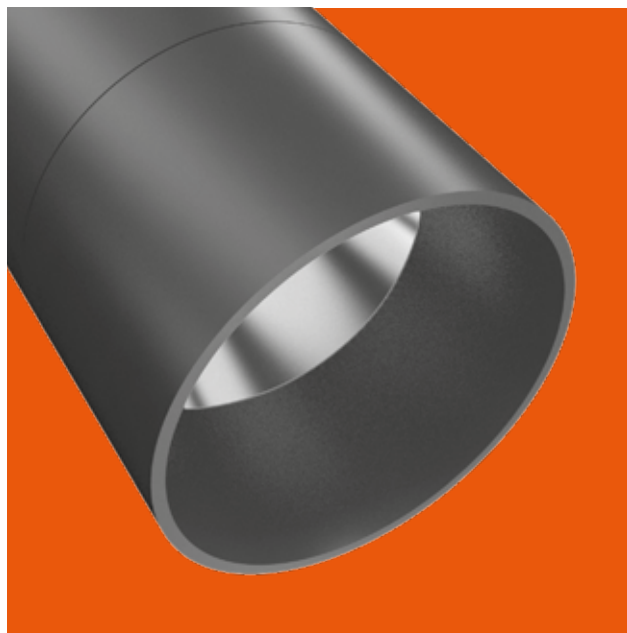

1

LIGHT SHADOW SPOT 30 / 45

Grâce à la solution optique exclusive et brevetée, le Light Shadow Spot contrôle des angles cut-off extrêmes sans compromettre la haute efficacité et l'incroyable polyvalence du produit.

Thanks to the unique patented optical solution, Light Shadow Spot controls extreme cut-off angles without altering the high efficiency and incredible versatility of the product.

2 Lentille à double foyer développée par FLOS spécifiquement pour ce produit. Elle assure un contrôle optique maximal et une homogénéité exceptionnelle du faisceau lumineux.
Dual-focus lens developed by FLOS specifically for this product. It ensures maximum optical control and exceptional light beam homogeneity.

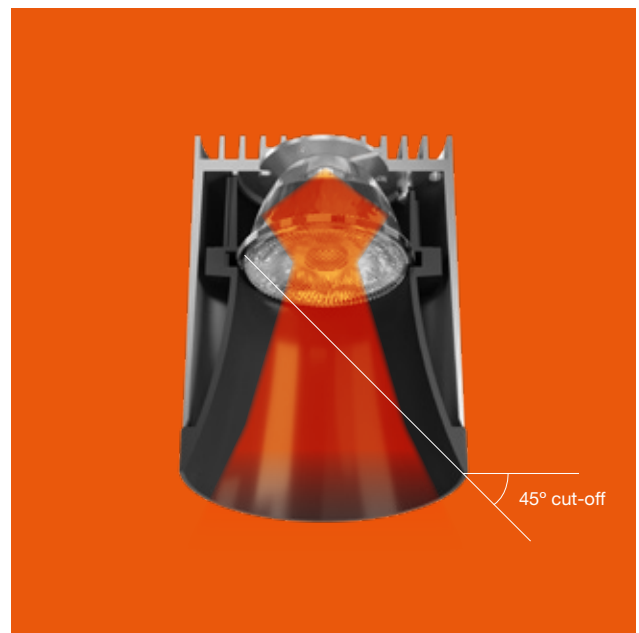

2

SPOT 120

Projecteur de puissance au design minimaliste.
Confort visuel maximal.

Power projector with minimal design.
Maximum visual comfort.

3 Accessoires de blindage disponibles pour tous les projecteurs, offrant un confort visuel maximal.
Shielding accessories available in all projectors, to always offer maximum visual comfort.

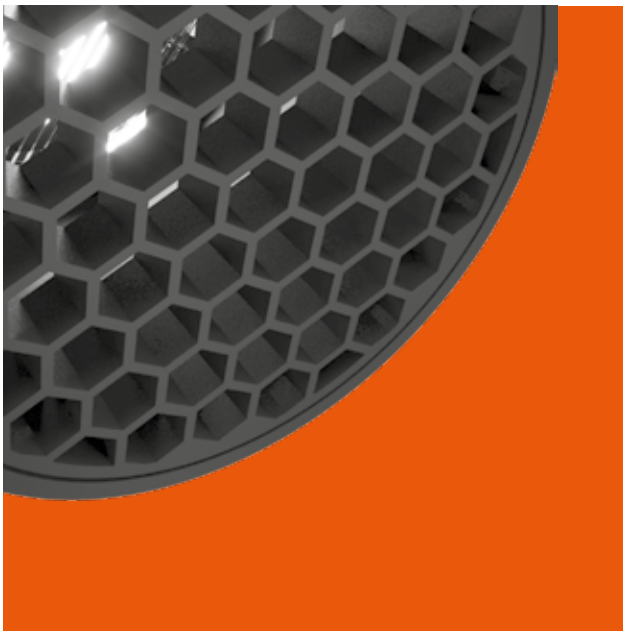
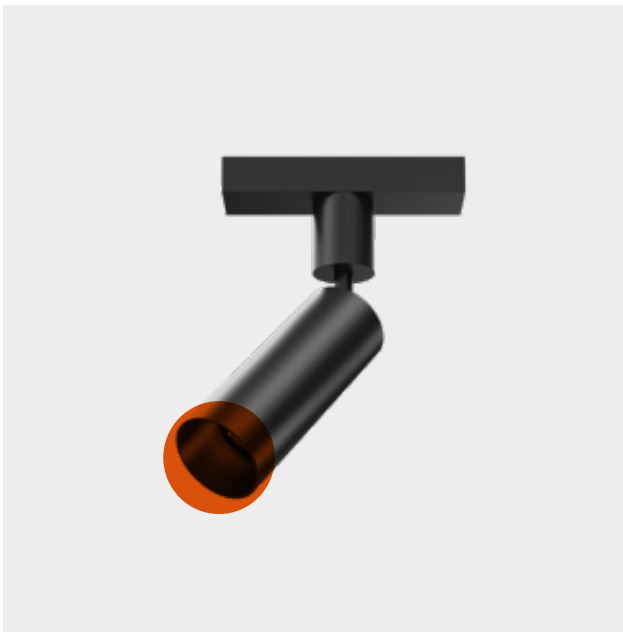

3

ANTHONY SPOT

Anthony Spot conçu par Antonio Citterio :
une forme avec une touche de design avant-gardiste, à la fois simple et élégant, qui se distingue des modèles traditionnels.

Anthony Spot designed by Antonio Citterio: a form with a touch of avant-garde design, simple yet elegant, which is distanced from traditional looks.

4 Design innovant du dissipateur de chaleur.
Novel heat dissipater design.



4



Estee Lauder
Headquarters, UK



Parc 51, Belgium
Bottom

1410 Broadway,
New York
Top

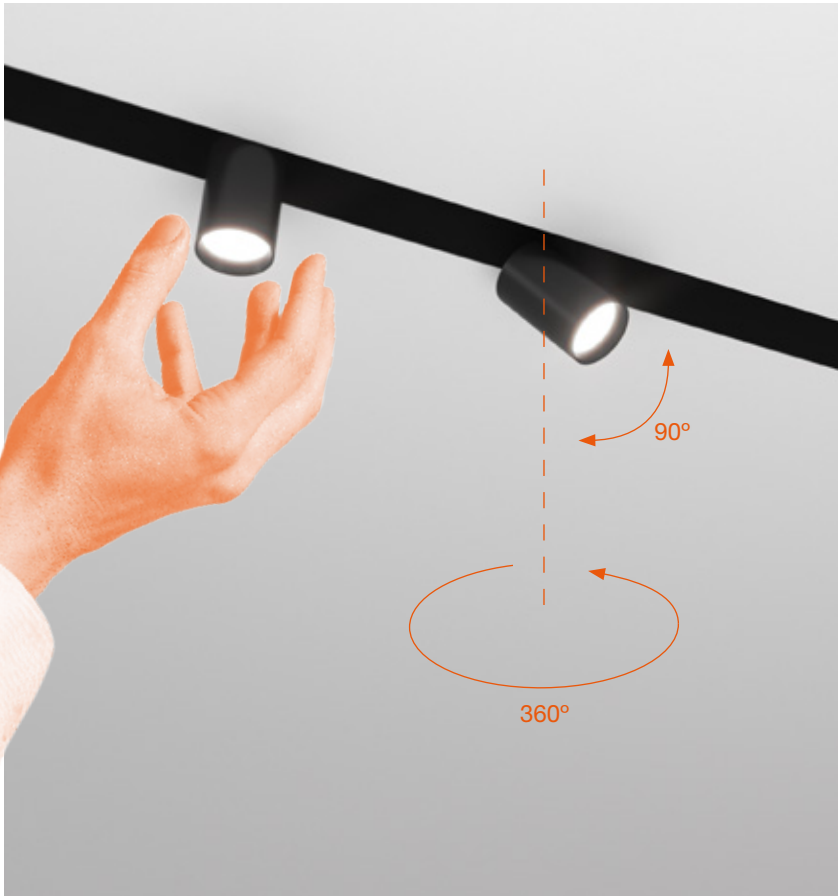

SPOT MODULE

Projecteur créé pour un maximum de flexibilité et d'intégration grâce à une installation affleurant le profilé. Lumière zénithale ou son extraction et orientation à 360 degrés et basculement à 90 degrés.

Projector created for maximum flexibility and integration, as it can be fitted flat to the profile. Zenithally light or its extraction and orientation to 360 degrees and tilting to 90 degrees.



SPOT SUSPENSION

Module de suspension sobre et extrêmement compact, idéal pour les effets de lumière à fort contraste.

Extremely compact and subtle suspension module, ideal for high-contrast lighting effects.







Barre lumineuse magnétique disponible en plusieurs longueurs raccordables entre elles sans effet de GAP même dans les angles (effet qui élimine l'interruption lumineuse sur la jonction). Le diffuseur opale conçu spécialement garantit à la fois l'efficacité et l'homogénéité dans l'intégration architecturale.

Magnetic light bar available in different lengths, which offers the possibility of joining and eliminating the gap effect, even in corners. The specially developed opal diffuser guarantees both efficiency and homogeneity in architectural integration.



LIGHT STRIPE

303 mm



603 mm



903 mm



1203 mm

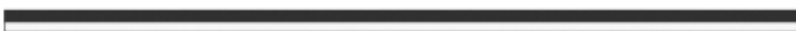





	Différentes options de contrôle peuvent être adaptées à n'importe quel besoin.	Different control options that can be adapted to any need.
ON BOARD DIMMING	Chaque luminaire possède son variateur intégré, pour un contrôle direct et individuel.	Each luminaire has its own integrated dimmer for direct and individual control.
DALI	Contrôle individuel de chaque luminaire.	Individual control of each luminaire.
1-10V	Contrôle à distance en broadcasting (variation de tous les luminaires dans un seul groupe).	Broadcasting remote control (dimming of all the luminaires in a single group).
CASAMBI	Disponible avec contrôle individuel de chaque luminaire avec une application sur tablet ou smartphone (FLOS Control®).	Individual control of each luminaire directly through a tablet or smartphone application (FLOS Control®).

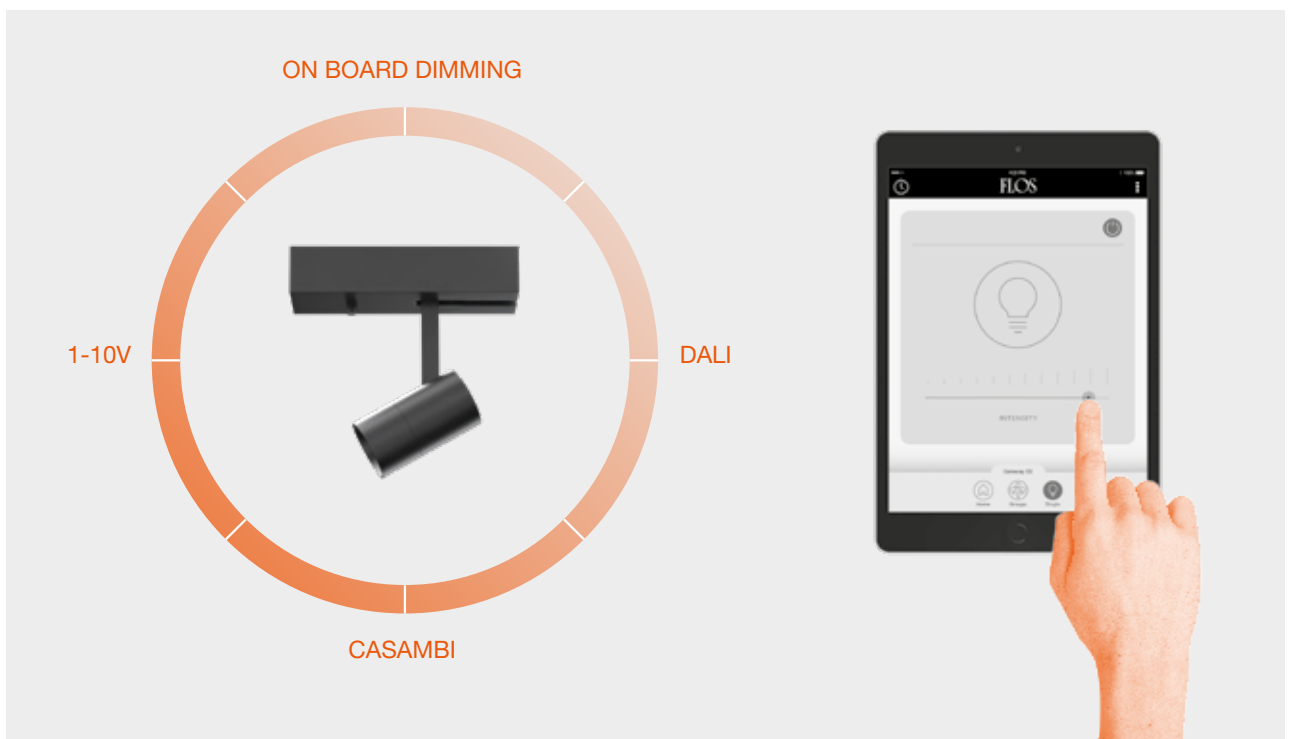

FLOS CONTROL®
BY CASAMBI

L'application FLOS Control® permet de contrôler les appareils d'éclairage du système individuellement ou par groupe, en contrôlant les scènes et la programmation.

Il suffit d'une installation électrique traditionnelle et du Gateway connecté par Bluetooth pour obtenir un contrôle total de l'espace.

Disponible pour IOS et Android

The FLOS Control® application allows you to control the system's luminaires individually or as a group, controlling scenes and programming.

With a traditional electrical installation and the Gateway connected by Bluetooth, you obtain total control of the ambience.

Available for iOS and Android

LIGHT MODULES

LIGHT STRIPE



TOP LED
25W/m



SPOT MODULE



POWER LED
8W

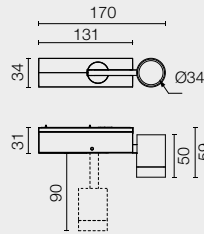

SPOT 120



POWER LED
12,5W/14W DALI

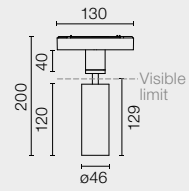

LIGHT SHADOW SPOT 30



POWER LED
4W

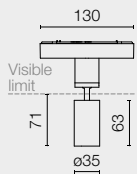

LIGHT SHADOW SPOT 45



LED ARRAY
10W

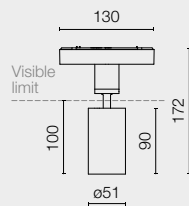

ANTHONY SPOT TRACK



POWER LED
14W

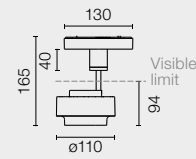

LIGHT MODULES

WORKMATES SMALL



TOP LED
Up to 10,5W

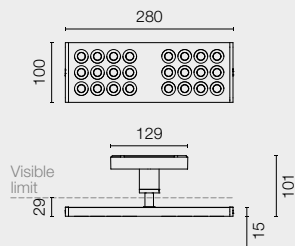

WORKMATES LARGE



TOP LED
Up to 13,5W

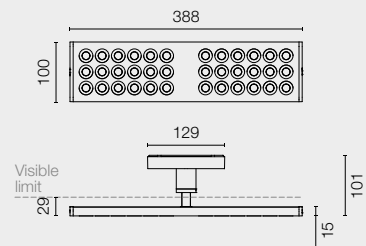

MULTI SPOT 4



POWER LED
10W

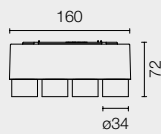

LIGHT SHADOW



POWER LED
10,8W

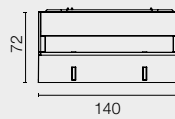

LIGHT SHADOW
WALL-WASHER



POWER LED
10,8W

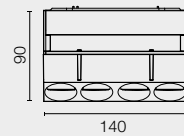

LIGHT MODULES

STRING LIGHT



POWER LED
14W

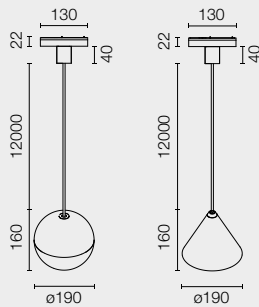

MINI GLO-BALL



POWER LED
3,5/7W

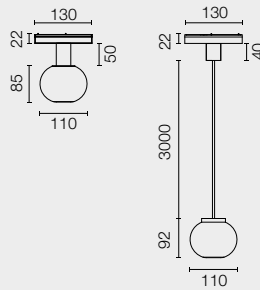

FIND ME
SUSPENSION



POWER LED
8W

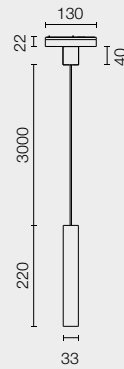

Spot



Medium



Flood



Wide Flood



Oval



Wall-Washer



Diffused

PROFILES

RECESSED



■ 14 Noir
14 Black

SURFACE



□ 40 Blanc
40 White

SUSPENSION
UP&DOWN / DOWN

■ 14 Noir
14 Black

MULTIFUNCTION
SMART DEVICE

FLOS CONTROL®
by Casambi

FLOS
CONTROL BY CASAMBI



THE TRACKING

MAGNET

WAGNIEL

MAGNET

WAGNIEL

MAGNET

WAGNIEL

Profilé compact et compatible avec des luminaires à fixation magnétique. Le programme comprend des versions encastrées, en surface et suspendues. Réglage et variation par protocoles universels et à travers l'application FLOS Control®.

Compact profile, compatible with magnetic fastening light fixtures. The program has recessed, surface and suspended versions. Regulation and control with universal protocols and using the FLOS Control® application.

THE TRACKING MAGNET

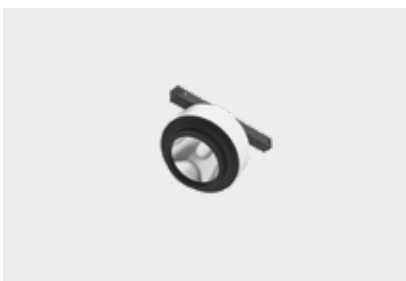
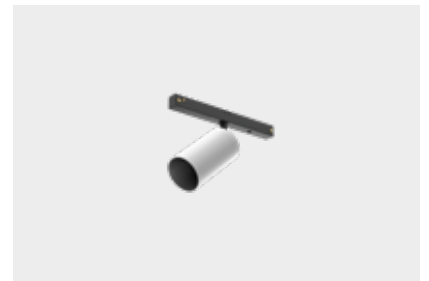
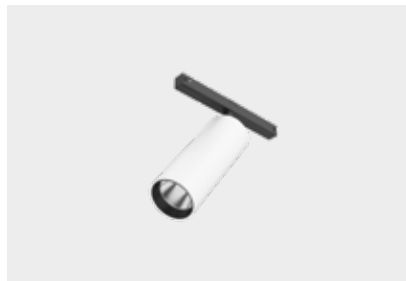





Le système est composé de profils magnétiques alimentés en 48V où sont placés les modules d'éclairage LED. Les profils conviennent à une installation en surface, suspendue ou encastrée dans des murs ou des plafonds en placoplâtre. Le Tracking Magnet est complété par des modules d'éclairage d'ambiance et d'accentuation avec diverses optiques, ainsi qu'un module spécial pour l'éclairage ponctuel au mur.

The system consists of magnetic profiles powered at 48V where the LED lighting modules are placed. The profiles are suitable for surface, suspended or recessed installations in walls or plasterboard ceilings. The Tracking Magnet is completed by ambient and accent lighting modules with different optics, as well as by a special module for spot lighting on walls.



- 1 RECESSED
- 2 SURFACE
- 3 SUSPENSION DOWN
- 4 SUSPENSION UP&DOWN

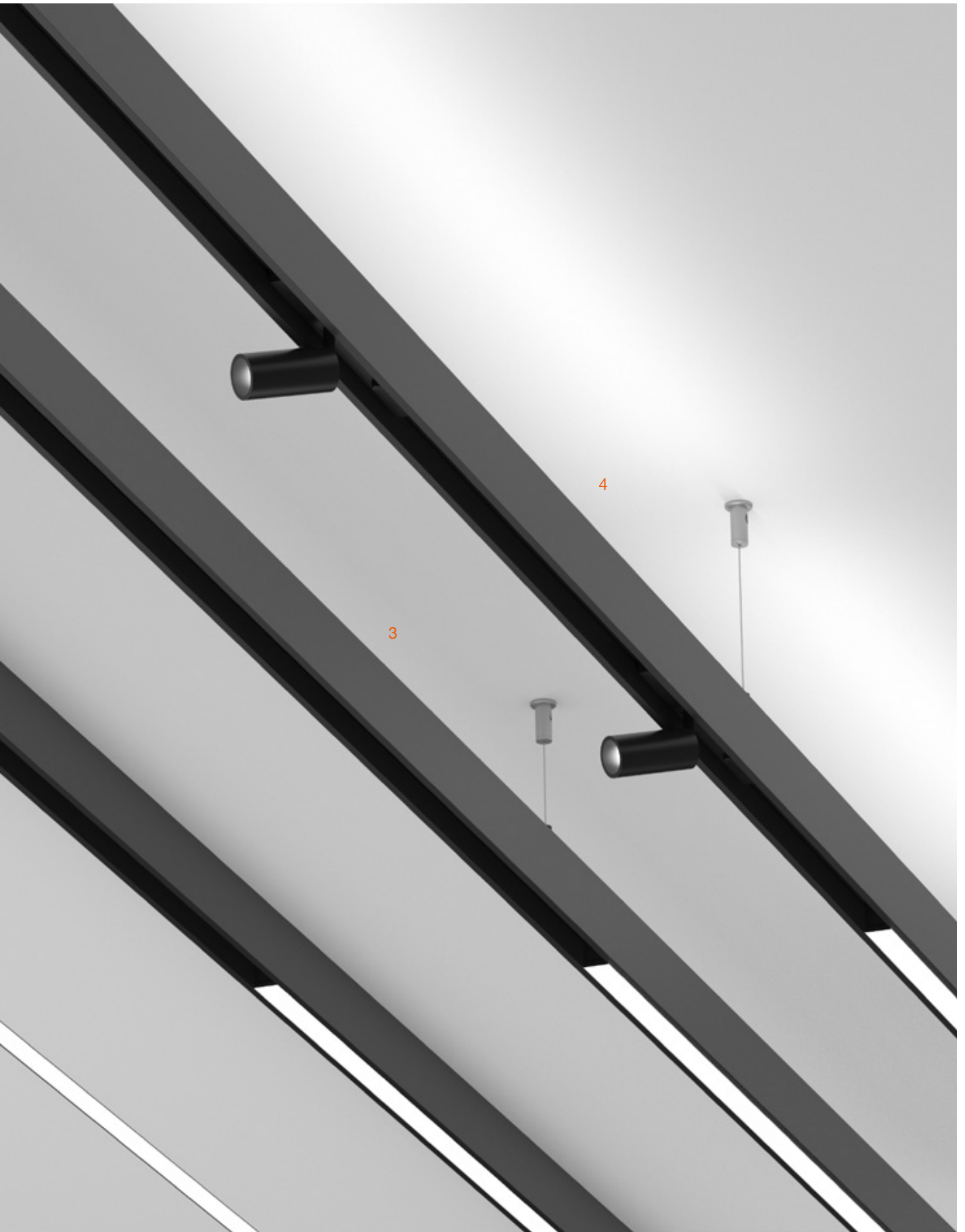









Une ligne minimale de seulement 15mm de largeur, réalisée grâce à la miniaturisation extrême des composants électroniques et des corps optiques. Le Tracking Magnet offre une gamme complète de produits adaptés à tous les besoins, compatibles avec tous les principaux systèmes de variation et FLOS Control®. Son installation magnétique permet une entière liberté de configuration dans l'espace.

A minimal line only 15 mm wide, achieved through the extreme miniaturization of the electronics and the optical bodies. The Tracking Magnet offers a complete collection of lighting tools for any need, compatible with all main control systems and FLOS Control®. Its magnetic installation gives total freedom to be configured in space.

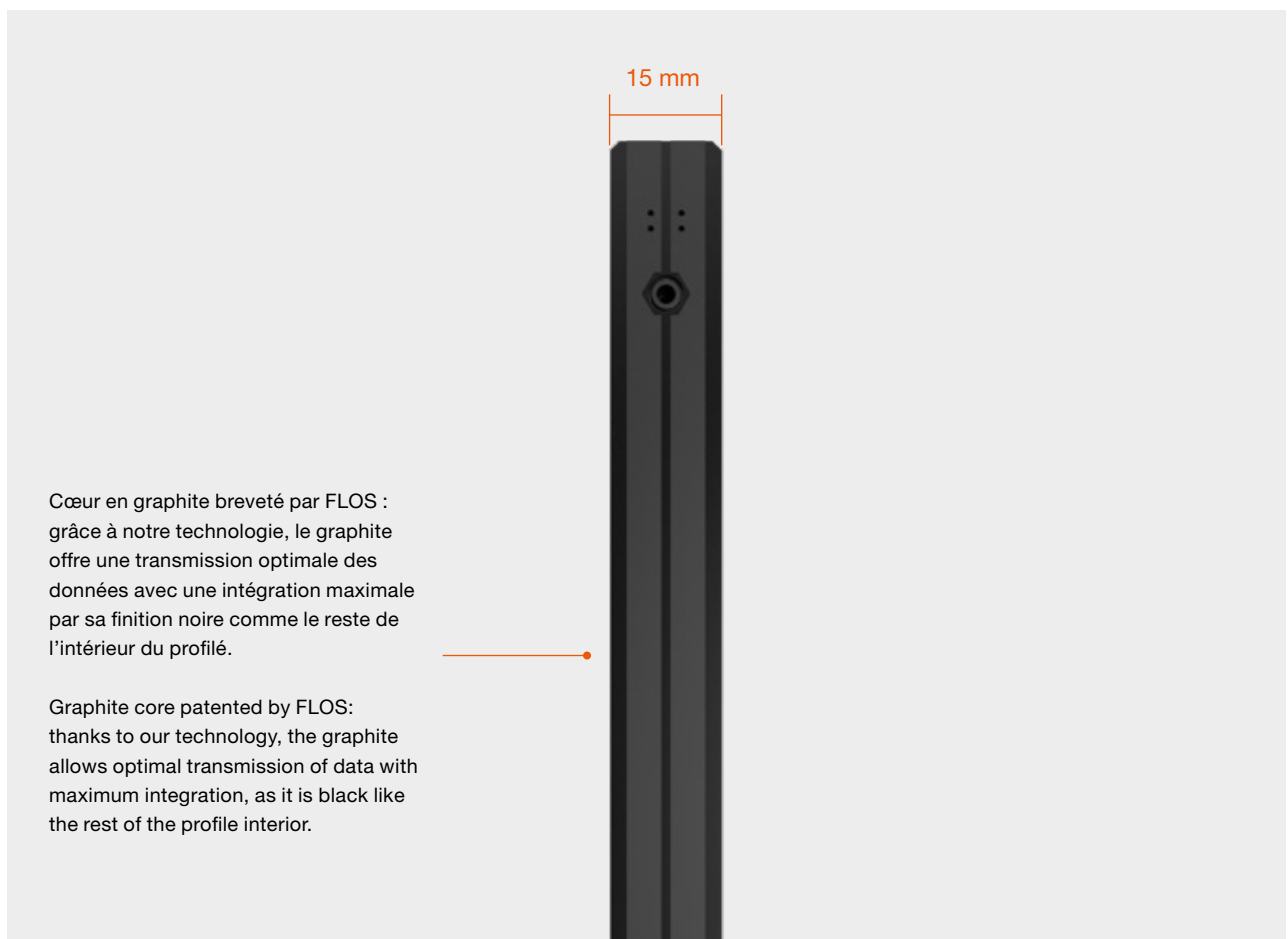









Fixation magnétique des luminaires qui permet de les manipuler même à chaud, de les déplacer lorsqu'ils sont allumés, offrant une flexibilité et une souplesse d'adaptation de la configuration à tout moment.

Magnetic fixing of the luminaires, which allows hot handling. They can be moved while the track is connected, achieving enormous flexibility and adaptability in the configuration at any time.





Bulb Millenium Offices,
Czech Republic

Barre lumineuse magnétique disponible en plusieurs longueurs raccordables entre elles sans effet de GAP même dans les angles (effet qui élimine l'interruption lumineuse sur la jonction). Le diffuseur opale conçu spécialement garantit à la fois l'efficacité et l'homogénéité dans l'intégration architecturale.

Magnetic light bar available in different lengths, which offers the possibility of joining and eliminating the gap effect, even in corners. The specially developed opal diffuser guarantees both efficiency and homogeneity in architectural integration.



303 mm

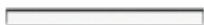

603 mm



903 mm



1203 mm



1503 mm





Carbonado Energy, South
Africa

LIGHT SHADOW SPOT 30 / 45

Grâce à la solution optique exclusive et brevetée, le Light Shadow Spot contrôle des angles cut-off extrêmes sans compromettre la haute efficacité et l'incroyable polyvalence du produit.

Thanks to the unique patented optical solution, Light Shadow Spot controls extreme cut-off angles without altering the high efficiency and incredible versatility of the product.

1 Lentille à double foyer développée par FLOS spécifiquement pour ce produit. Elle assure un contrôle optique maximal et une homogénéité exceptionnelle du faisceau lumineux.
Dual-focus lens developed by FLOS specifically for this product. It ensures maximum optical control and exceptional light beam homogeneity.

SPOT TRACKING 50 / 90 / 120 / 150

Famille de projecteurs de différentes puissances et optiques pour répondre à toutes les contraintes.

Family of spots with different powers and optics for any need.

2 Versions spot 120 et 150 avec optique à réflecteurs pour des faisceaux lumineux plus ouverts et plus de puissance.
Spot versions 120 and 150 with reflector optics available, to offer wider and more powerful light beams.

LIGHT SHADOW SPOT 30

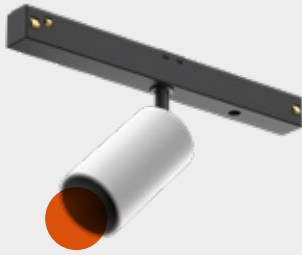

SPOT 150

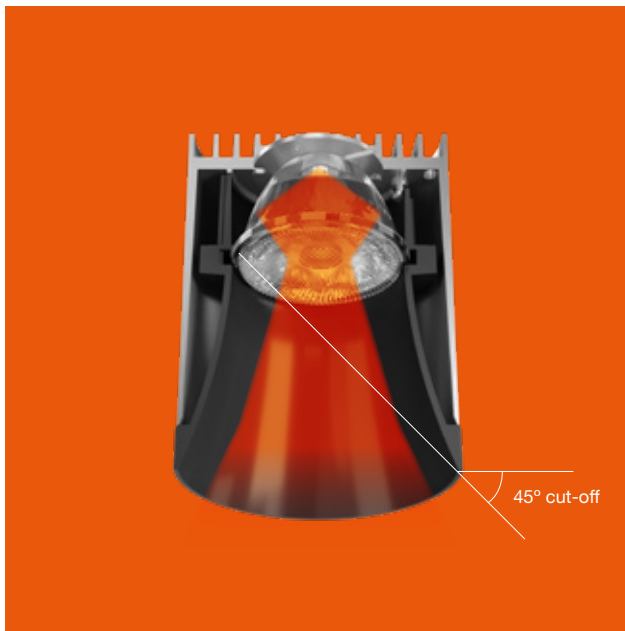

1



2

WALLEE

Luminaire conçu par Niels Bendtsen pour l'éclairage spécifique des tableaux et des murs, grâce à sa distribution homogène et élégante de la lumière de haute qualité.

Luminaire designed especially by Niels Bendtsen for lighting frames and walls, thanks to its homogenous and elegant distribution of high-quality light.

3 Tête orientable à 50 degrés pour un parfait réglage de l'éclairage.
Head adjustable to 50 degrees for the perfect light setting.

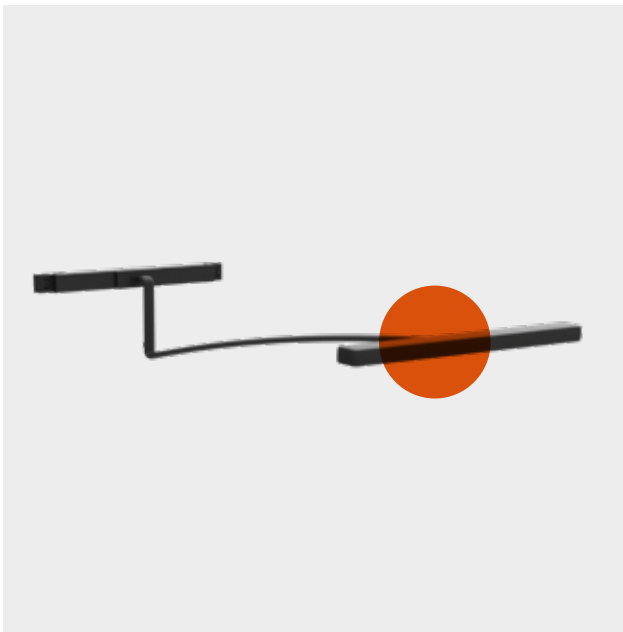

3

ANTHONY SPOT

Anthony Spot conçu par Antonio Citterio: une forme avec une touche de design, à la fois simple et élégante, qui se distingue des modèles traditionnels.

Anthony Spot designed by Antonio Citterio: a form with a touch of avant-garde design, simple yet elegant, which is distanced from the traditional looks.

4 Design innovant du dissipateur de chaleur.
Novel heat dissipater design.

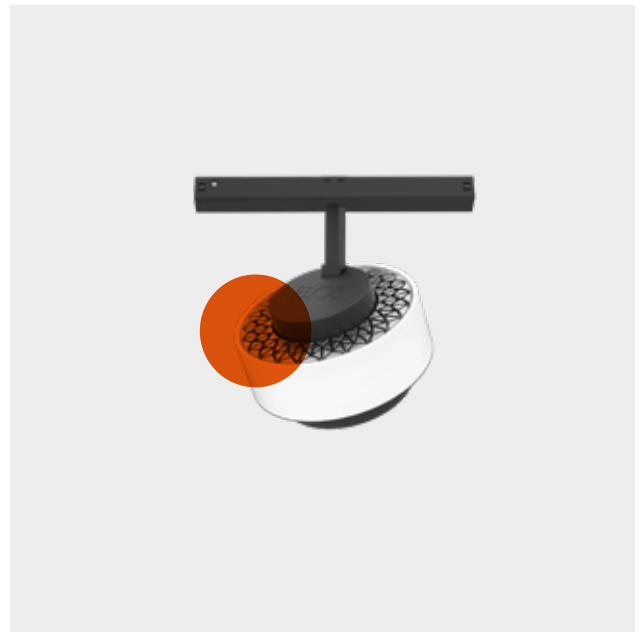

4



Sergio Rossi, London

	Différentes options de contrôle peuvent être adaptées à n'importe quel besoin.	Different control options that can be adapted to any need.
ON BOARD DIMMING	Chaque luminaire possède son variateur intégré, pour un contrôle direct et individuel.	Each luminaire has its own integrated dimmer for direct and individual control.
DALI	Contrôle individuel de chaque luminaire.	Individual control of each luminaire.
1-10V	Contrôle à distance en broadcasting (variation de tous les luminaires dans un seul groupe).	Broadcasting remote control (dimming of all the luminaires in a single group).
CASAMBI	Disponible avec contrôle individuel de chaque luminaire avec une application sur tablet ou smartphone (FLOS Control®).	Individual control of each luminaire directly through a tablet or smartphone application (FLOS Control®).



FLOS CONTROL®
BY CASAMBI

L'application FLOS Control® permet de contrôler les appareils d'éclairage du système individuellement ou par groupe, en contrôlant les scènes et la programmation.

Il suffit d'une installation électrique traditionnelle et du Gateway connecté par Bluetooth pour obtenir un contrôle total de l'espace.

Disponible pour IOS et Android

The FLOS Control® application allows you to control the system's luminaires individually or as a group, controlling scenes and programming.

With a traditional electrical installation and the Gateway connected by Bluetooth, you obtain total control of the ambience.

Available for iOS and Android





LIGHT MODULES

LIGHT STRIPE



TOP LED
20W/M

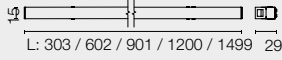

SPOT 50



POWER LED
3,5W

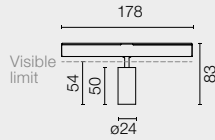

SPOT 90



POWER LED
8,5W

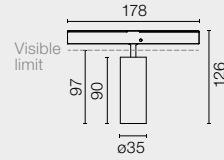

SPOT 120



POWER LED
12W

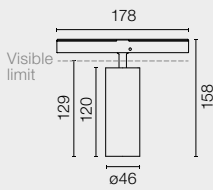

SPOT 120



LED ARRAY
12,5W

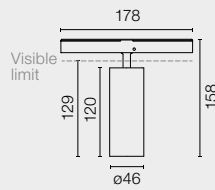

SPOT 150



LED ARRAY
22,5W

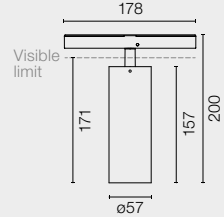

LIGHT SHADOW SPOT 30



POWER LED
4,5W

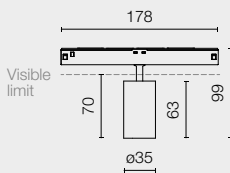

LIGHT SHADOW SPOT 45



LED ARRAY
10W

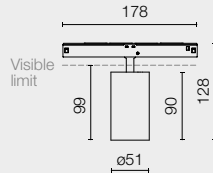

LIGHT SHADOW SPOT 60



LED ARRAY
Up to 20W

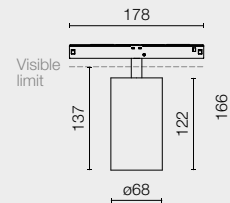

Super Spot



Spot



Medium



Flood



Wide Flood

LIGHT MODULES

WALLEE



TOP LED
10W

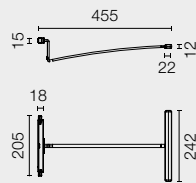

ANTHONY SPOT TRACK



LED ARRAY
16,5W

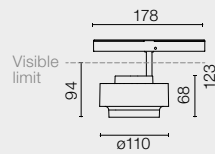

RECESSED



■ 14 Noir
■ 14 Black

SURFACE



□ 40 Blanc
□ 40 White

SUSPENSION
UP&DOWN / DOWN



■ 14 Noir
■ 14 Black

MULTIFUNCTION
SMART DEVICE



FLOS CONTROL®
by Casambi



THE TRACKING

P

PO

POW

POWE

POWER

Rail triphasé aux dimensions réduites en version encastrée et en surface. Compatible avec une famille de luminaires compacts et puissants. Réflecteurs à haut rendement.

3-phase rail with reduced dimensions in its recessed and surface version. Compatible with a compact and powerful light fixture program. High efficiency reflectors.

THE TRACKING POWER

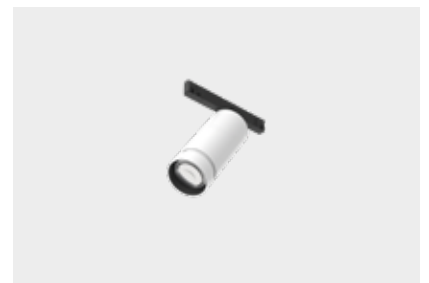
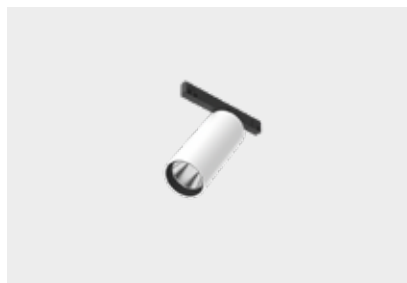
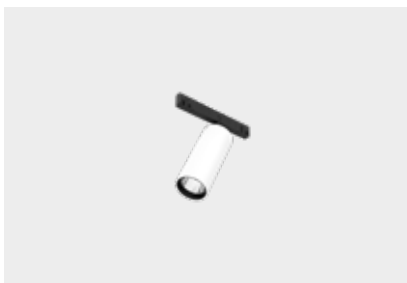



Issey Miyake Store,
Germany



Le Tracking Power est équipé de pistes électriques sur lesquelles les luminaires sont installés grâce à un système de fixation exclusif de Flos. Après l'installation du rail, seule une fine ligne de 15 mm d'épaisseur est visible.

The Tracking Power is equipped with electric tracks on which the luminaires are installed through an exclusive Flos fixing system. After installing the track, only a thin, 15 mm thick line will be visible.





Versace Boutique, Miami

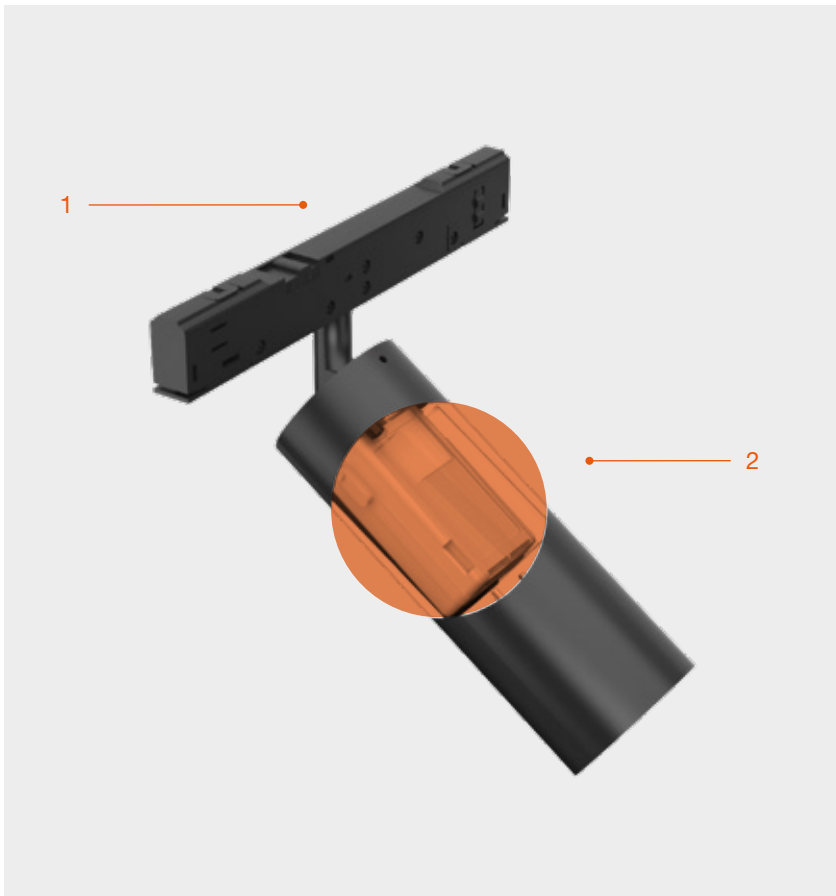

Le rail triphasé selon Flos. Grâce à son système d'ancrage miniaturisé, il est capable d'accueillir, dans un espace de seulement 15 mm, une gamme complète d'appareils d'éclairage haute puissance pour des applications professionnelles.

The three-phase rail according to Flos. Thanks to its miniaturized anchorage system it is capable to host in a space of only 15 mm a complete range of high power lighting tools for professional applications.

UT SPOT MODULES

1 Rail au design révolutionnaire qui permet une intégration totale dans la ligne de 15 mm.
Revolutionary track design that allows total integration in the 15mm line.

2 Electronique de contrôle totalement intégrée dans la tête du projecteur.
Control electronics totally integrated into the projector head.

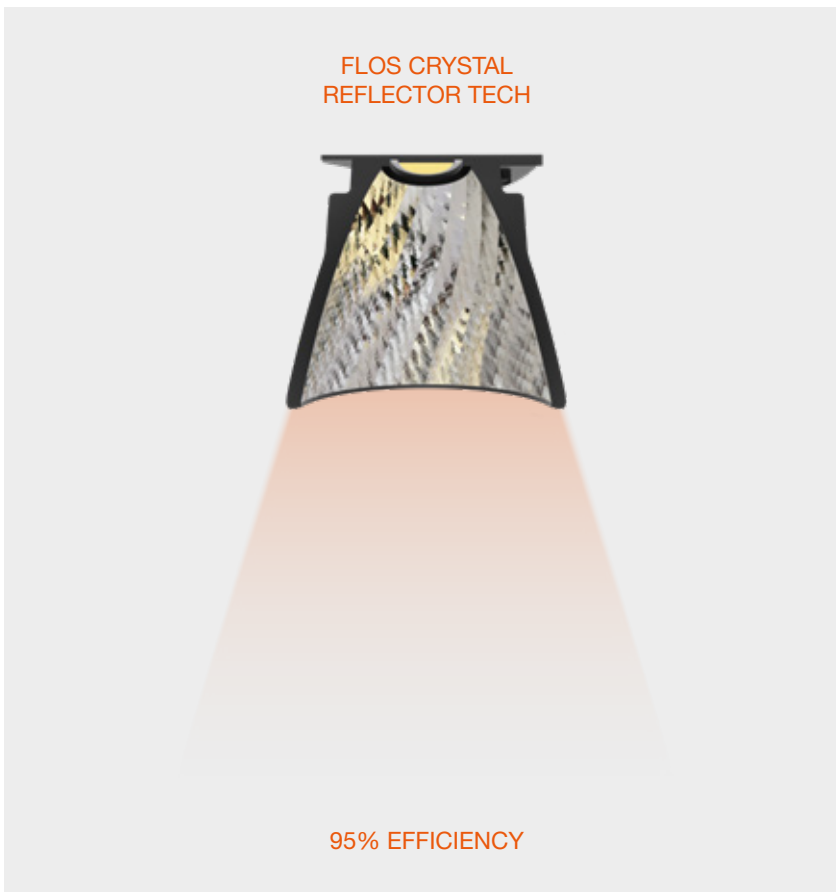

Réflecteur en verre borosilicate révolutionnaire qui offre un rendement lumineux jusqu'à 95%. Grâce à ses facettes, il garantit un contrôle total du faisceau de lumière.

Revolutionary reflector in borosilicate glass that offers light efficiency of up to 95%. Thanks to its faceting, it guarantees total control of the light beam.



Ce projecteur contient un innovant système réglable à double lentille bifocale qui permet de contrôler l'angle d'ouverture du faisceau lumineux de 13 à 56 degrés, en maintenant de hauts niveaux d'efficacité.

This projector incorporates an innovative adjustable system with double bifocal lenses, which allows the light beam opening angle to be controlled from 13 degrees to 56 degrees, while maintaining high levels of efficiency.



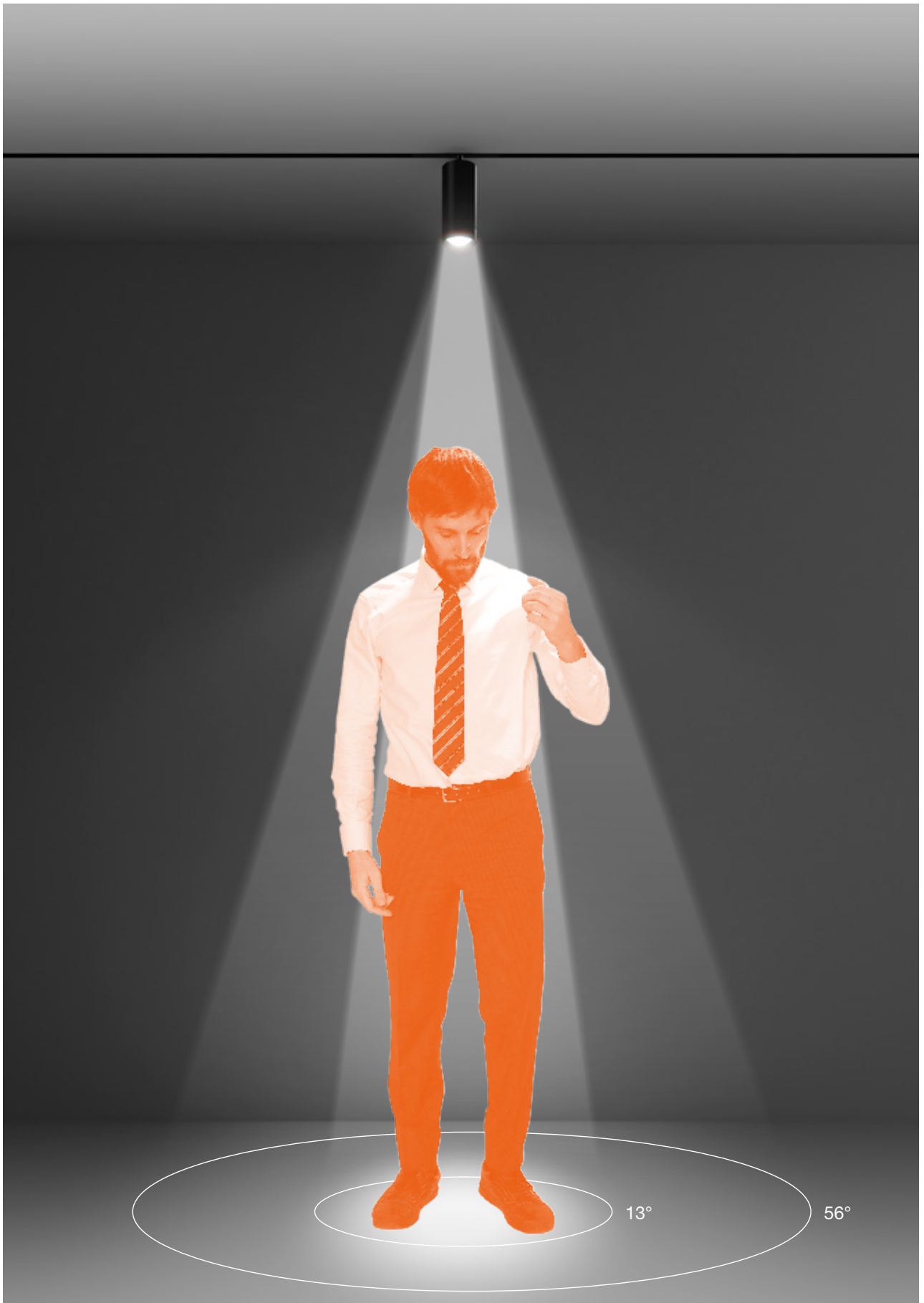





SPOT 150 / SPOT 175

Projecteurs au design minimaliste qui s'intègrent dans tous les espaces offrant différentes options d'angle et de puissances.

Projectors with minimal design which can be integrated into all aesthetics and with different angle and power options.

1 Potentiomètre embarqué pour le contrôle individuel de l'intensité de chaque appareil d'éclairage.
On-board Dimming for individual intensity control for each luminaire.

2 Accessoires de blindage fournis pour tous les projecteurs.
Shielding accessories available for all projectors.



SPOT 175 LENS

Projecteur à double lentille bifocale ajustable, qui permet de régler l'angle de 13 à 56 degrés.

Projector with adjustable double bifocal lenses, which allows angle adjustment from 13 to 56 degrees.

3 Lentille ajustable bifocale avec anneau de blindage.
Adjustable bifocal lenses with shielding ring.



3

WALL WASHER

Nouveau wall-washer qui, grâce à son réflecteur conçu par FLOS, offre une dimension extra compacte et des niveaux d'homogénéité lumineuse parfaits.

New wall-washer which, thanks to its reflector designed by FLOS, offers an extra compact size together with impeccable levels of light homogeneity.

4 Source lumineuse pour rétroprojection pour un confort visuel et une homogénéité maximum.
Back projection light source for maximum visual comfort and homogeneity.

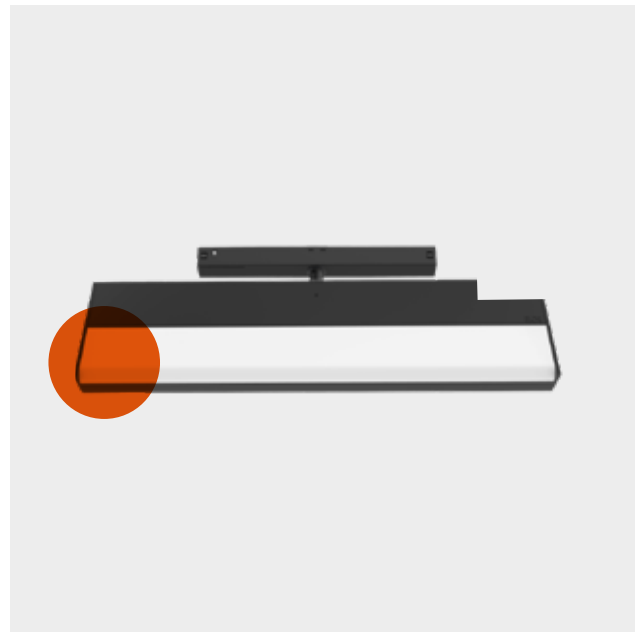

4



Kvadrat Showroom,
Copenhagen



Bombas Gens, Spain

RECESSED

SURFACE



■ 14 Noir
■ 14 Black

□ 40 Blanc
□ 40 White

■ 14 Noir
■ 14 Black

LIGHT MODULES - TRACKING POWER INSTALLATION

UT PRO 150



LED ARRAY
21W

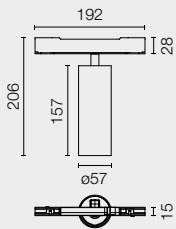

UT PRO 175



LED ARRAY
35,3W

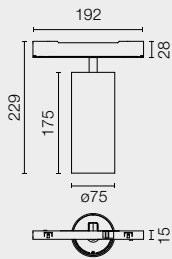

UT PRO 175 LENS



LED ARRAY
35,3W

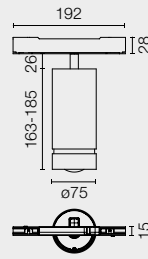

UT PRO WALL-WASHER

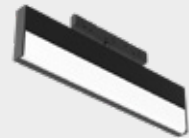

TOP LED
25,5W

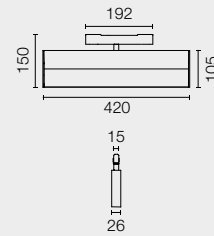

+ Info chapitre UT / + Info UT chapter



Spot



Medium



Flood



Wall-Washer

LIGHT MODULES - TRACKING POWER INSTALLATION

CAMERA Ø60



LED ARRAY
UP to 20W

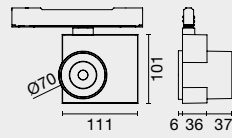

CAMERA Ø90



LED ARRAY
UP to 32W

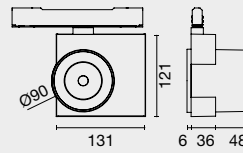

+ Info chapitre Camera / + Info Camera chapter

□ 40 Blanc
40 White

■ 14 Noir
14 Black



Super Spot



Spot



Medium



Flood



Wide Flood

FLOS
CONTROL BY CASAMBI



**THE
THE
THE
THE**

**FAST
FAST
FAST
FAST**

**TRACK
TRACK
TRACK
TRACK**

Système capable de déplacer et d'orienter des projecteurs motorisés le long d'une structure. Versions à haut rendement avec optiques de superspot à flood. Manipulation facile au moyen de l'exclusif FLOS Control®.

A system capable of moving and guide motorised projectors along a structure. High efficiency versions with optics from superspot to flood. Easy handling through the exclusive FLOS Control®.

THE FAST TRACK







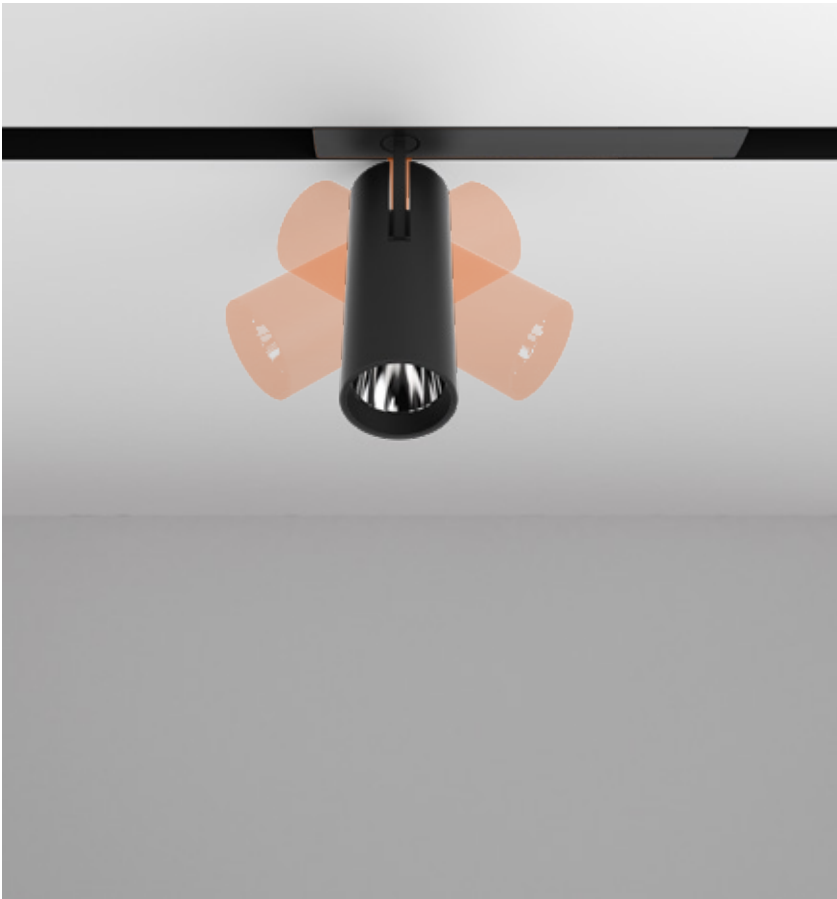

Produit révolutionnaire qui permet de gérer le mouvement sur trois axes : rotation, inclinaison, déplacement.

Revolutionary product that allows movement management in the three axes: rotation, tilting and translation.



Contrôle facile de la lumière avec l'application FLOS Control® disponible en versions IOS et Android. Connexion facile par Bluetooth.

Easy light control from the FLOS Control® application available for IOS and Android. Friendly interface with bluetooth connection.





Flos accède à un niveau sans précédent.
Mouvement de déplacement et d'orientation
exclusif d'un système de projecteurs program-
 mable et variable à distance avec FLOS Control®.
 Technologie extrême et simplicité du service.

Flos moves to an unprecedented level. Exclusive
translation and orientation movement of a projec-
 tors system capable of being programmed and
 controlled remotely with FLOS Control®. Extreme
 technology & simplicity of service.

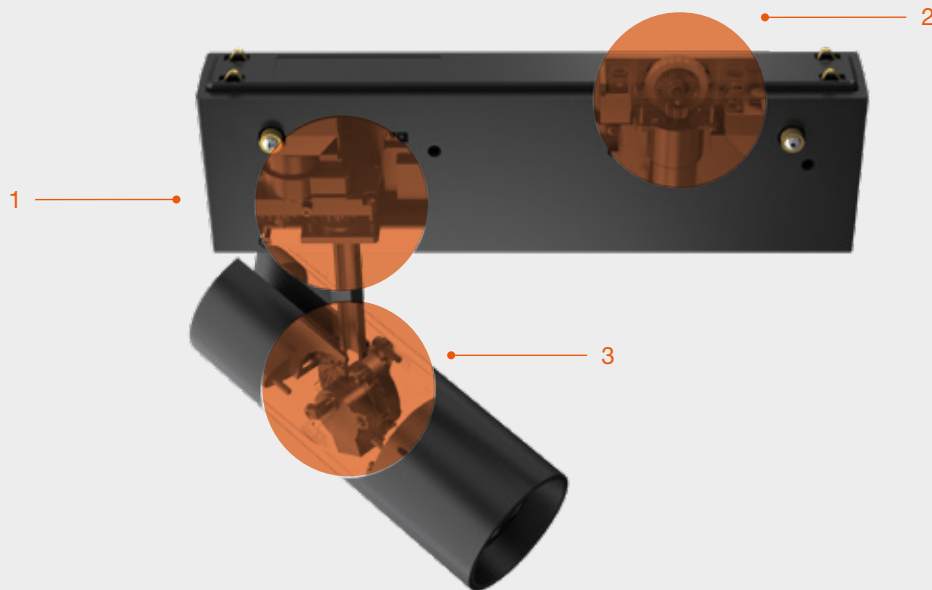

1 Moteur de rotation. Capteur
 optique qui détecte la position du
 spot sur le profilé à tout moment.
 Rotation motor. Optical sensor that
 detects the spot position in the
 profile at any time.

2 Moteur de déplacement.
 Roulement en caoutchouc équipé
 d'un amortisseur qui assure un
 contact permanent avec le profilé
 pour un déplacement parfait.
 Translation motor.
 Rubber bearing equipped with
 a shock absorber that ensures
 constant contact with the profile for
 an excellent translation.

3 Moteur de basculement.
 Capteur de fin de course.
 Tilt motor.
 Limit switch sensor.

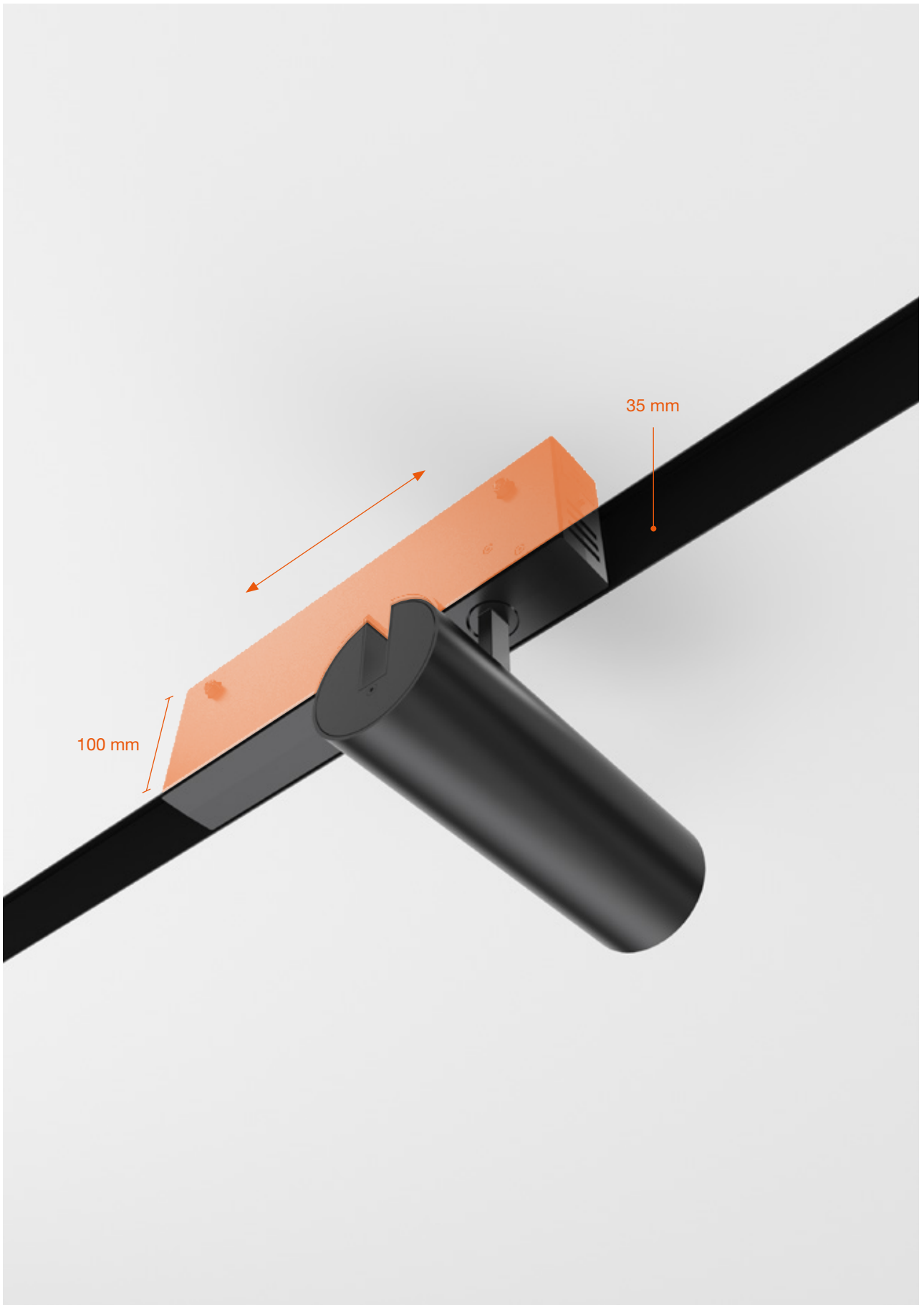



THE FAST TRACK 100

Une gamme complète de projecteurs professionnels: diverses options de puissance, et optique de super spot à flood.

A complete range of professional spotlights: various power options, and optic from super spot to flood.

1 Versions avec optique multi-lentilles à haut rendement avec angles à 4 degrés.
Versions with high-efficiency multi-lens optics with up to 4-degree angles are available.



1

THE FAST TRACK 150

2 Accessoire à nids d'abeille anti-éblouissement pour un parfait contrôle visuel.
Honeycomb accessory for a perfect visual control and shielding.

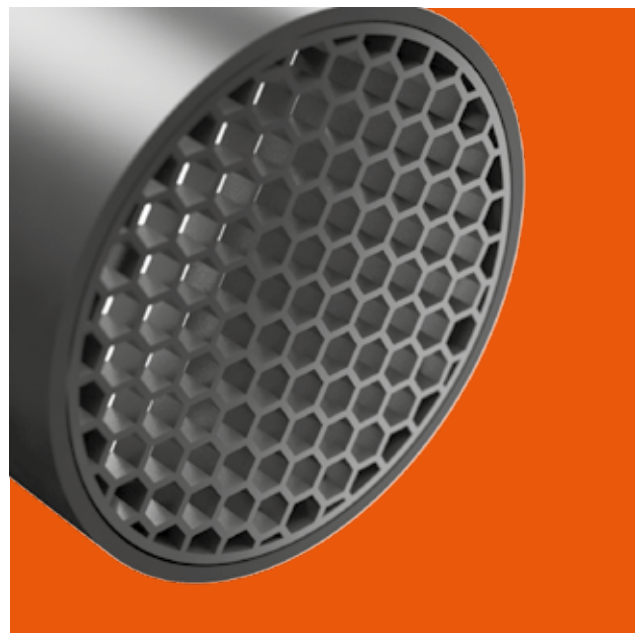

2



Grâce à l'application, vous pouvez configurer chacun des luminaires, enregistrer son orientation et générer un scénario d'éclairage personnalisé.

Thanks to the application you can set up each luminaire, save their orientation and generate a lighting scenario.

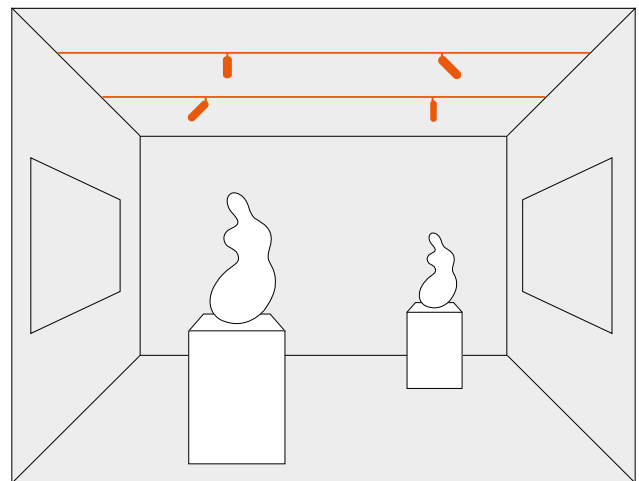
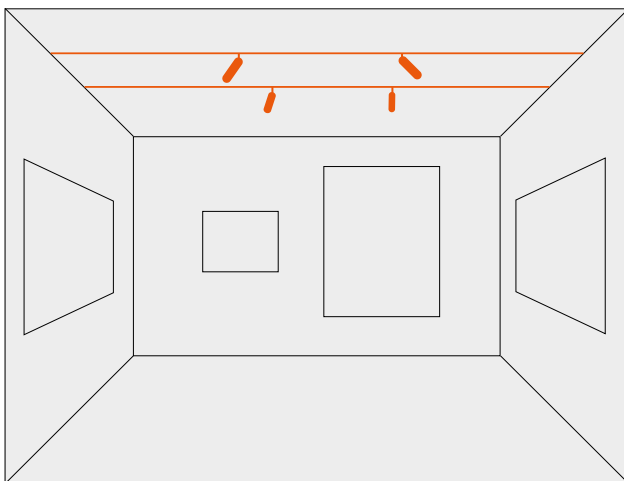

L'application offre également la possibilité de scénario et de gestion et d'activation planifiée.

The application also offers the possibility of scenario management and scheduled activation.

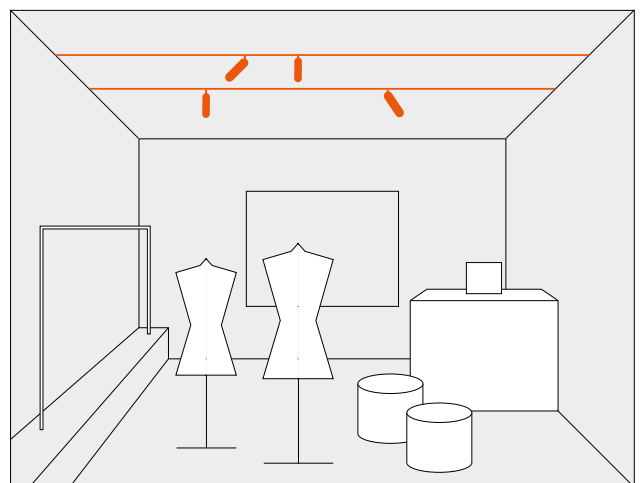
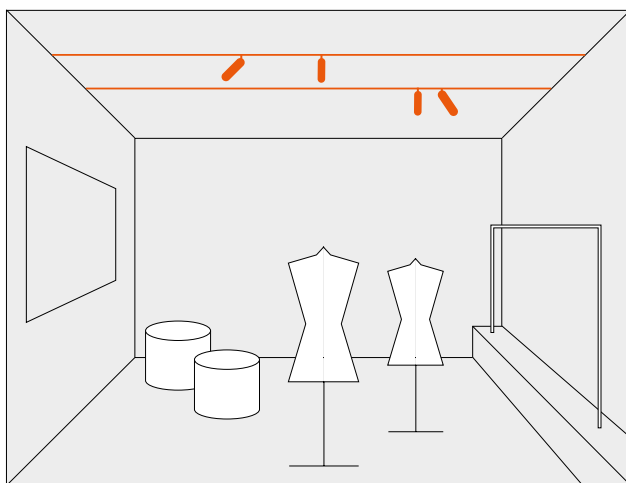
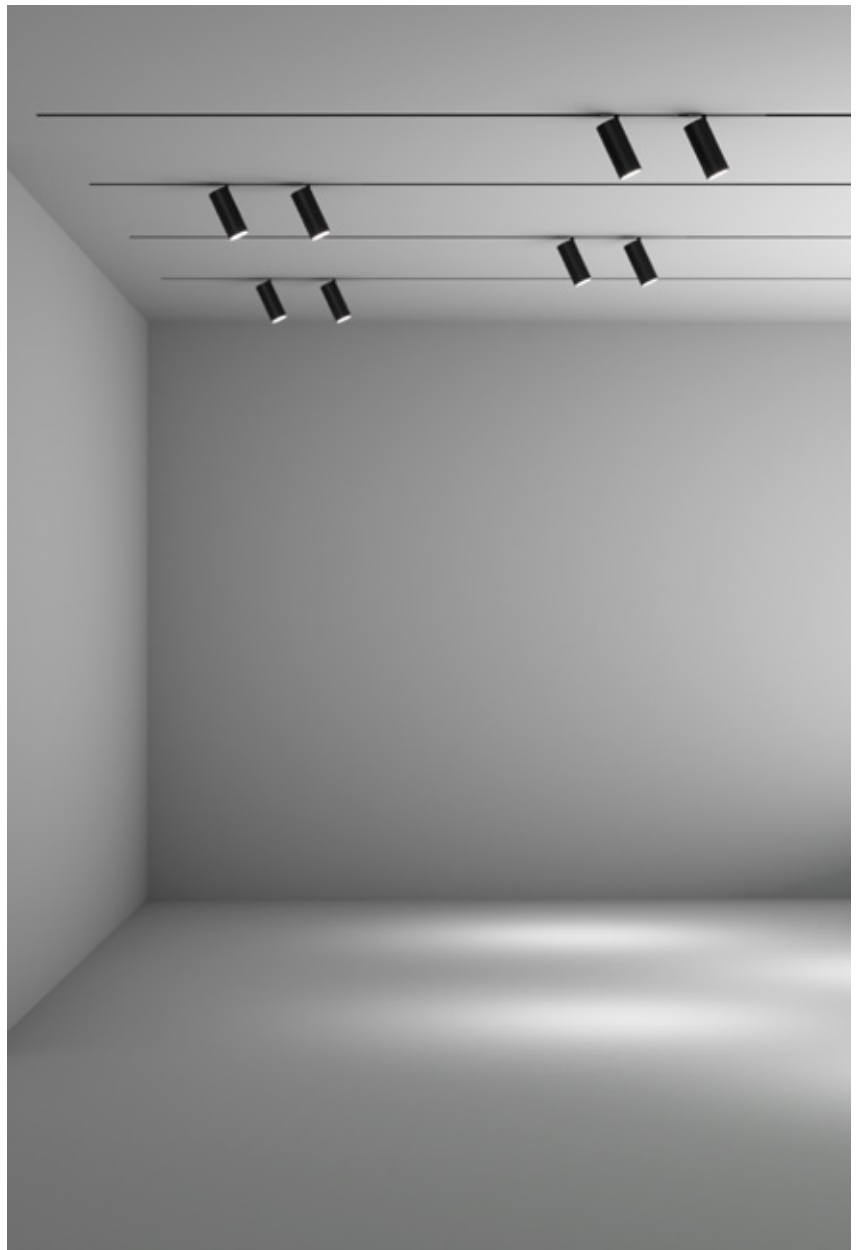



Arclinea Showroom, Italy

LIGHT MODULES

THE FAST TRACK
SPOT 100



POWER LED
13W

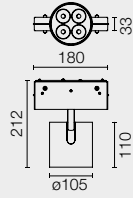

THE FAST TRACK
SPOT 150



LED ARRAY
25,5W

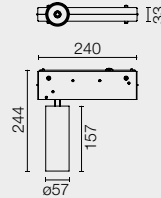

Super Spot



Spot



Medium



Flood

RECESSED



■ 14 Noir
14 Black

SURFACE



□ 40 Blanc
40 White ■ 14 Noir
14 Black



■ 14 Noir
14 Black



□ BW Blanc
BW White

MULTIFUNCTION
SMART DEVICE



FLOS CONTROL®
by Casambi

**W
WORKMATES
M**

Le paradigme du bureau classique n'est plus le *statu quo* pour les espaces professionnels. Les nouveaux modèles de travail hybrides ont redéfini leurs architectures, leurs usages et leurs fonctionnalités. Workmates est l'écosystème d'éclairage Flos pour les nouveaux espaces de travail contemporains et multidisciplinaires.

The traditional office paradigm is no longer the *statu quo* for professional spaces. New hybrid models of working have redefined their architectures, uses and functionalities. Workmates is Flos' luminaire ecosystem for new contemporary and multidisciplinary work spaces.

WORKMATES

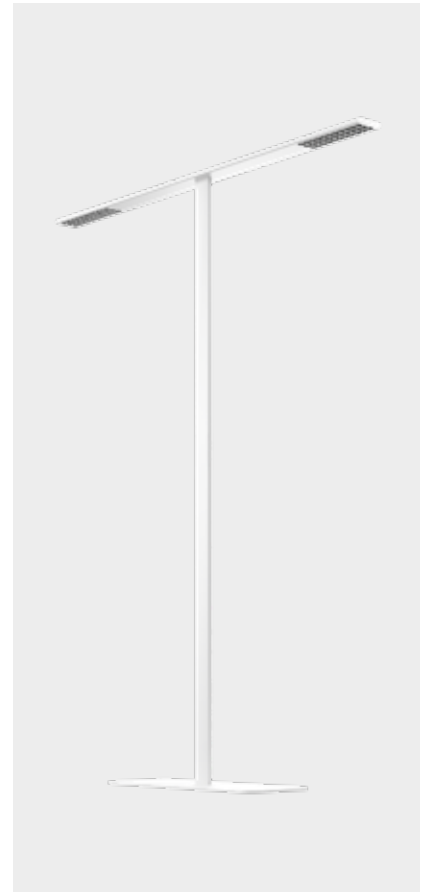
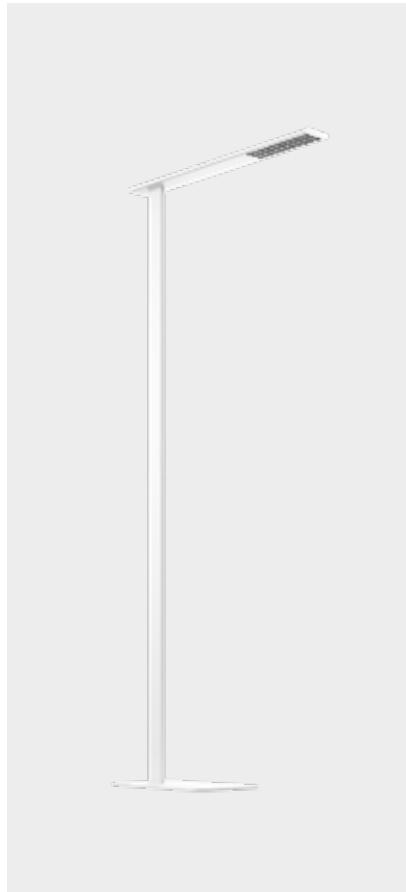
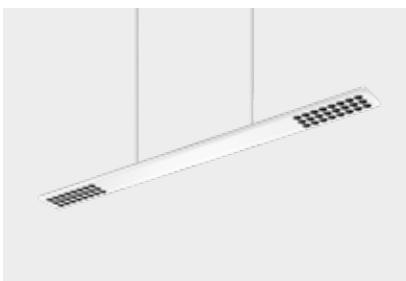

Une collection de produits conçus pour répondre avec polyvalence à tous les besoins d'éclairage. Un concept d'éclairage qui place le bien-être de la personne au centre de son développement technique et ajoute une attention particulière à l'esthétique et aux détails qui émane de l'identité différentielle du design Flos. Workmates se décline en 4 options d'installation (plafond, suspension, sol et rail), pour s'adapter aux besoins d'installation de tous les espaces.

A collection of products designed to answer any lighting need with versatility. A lighting concept that places personal well-being at the very core of its technical development and adds careful attention to the aesthetics and details that emanate from the differential identity of the Flos design. Workmates comes in 4 installation options (ceiling surface, suspension, floor and track), in order to adapt to the installation requirements of any space.

- 1 CEILING
- 2 TRACK
- 3 SUSPENSION
- 4 FLOOR DOUBLE
- 5 FLOOR SINGLE

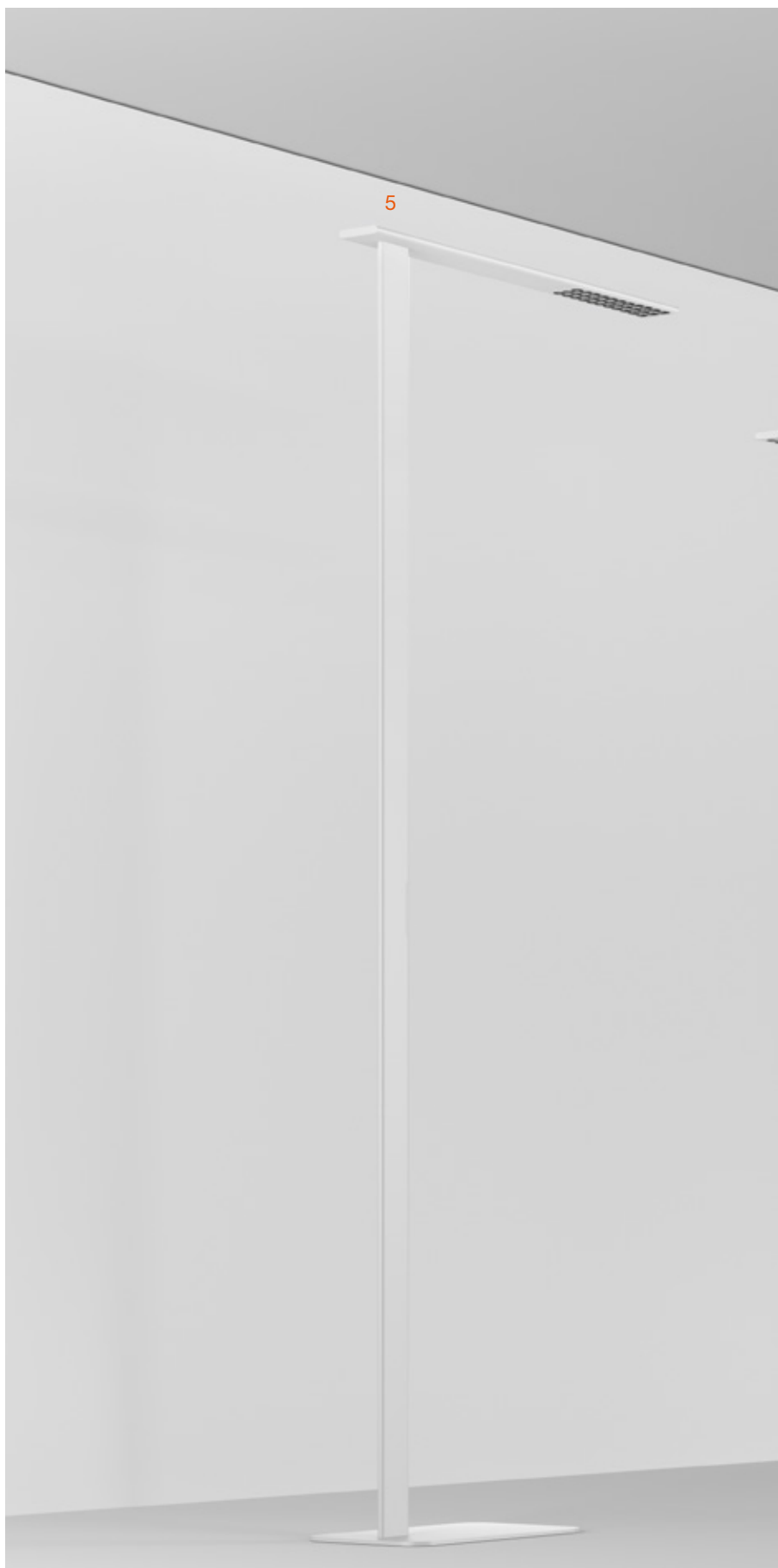



L'espace de travail n'est plus en contradiction avec la beauté du meilleur design. Les détails comptent, c'est pourquoi Workmates est du pur Flos. D'une présence magnétique, il est élancé, minimaliste, subtil... Workmates est proposé dans une gamme de finitions sélectionnées : All White, White et Black. De plus, dans tous les modèles sauf celui du sol, la belle finition Anodized Silver est proposée.

The workspace is no longer at odds with the beauty of optimal design. Details matter, and that is why Workmates is pure Flos. With its magnetic presence, it is slim, minimalist, subtle... Workmates comes in a range of select finishes: All White, White and Black. In addition, the attractive Anodized Silver finish is available in all models except the floor option.





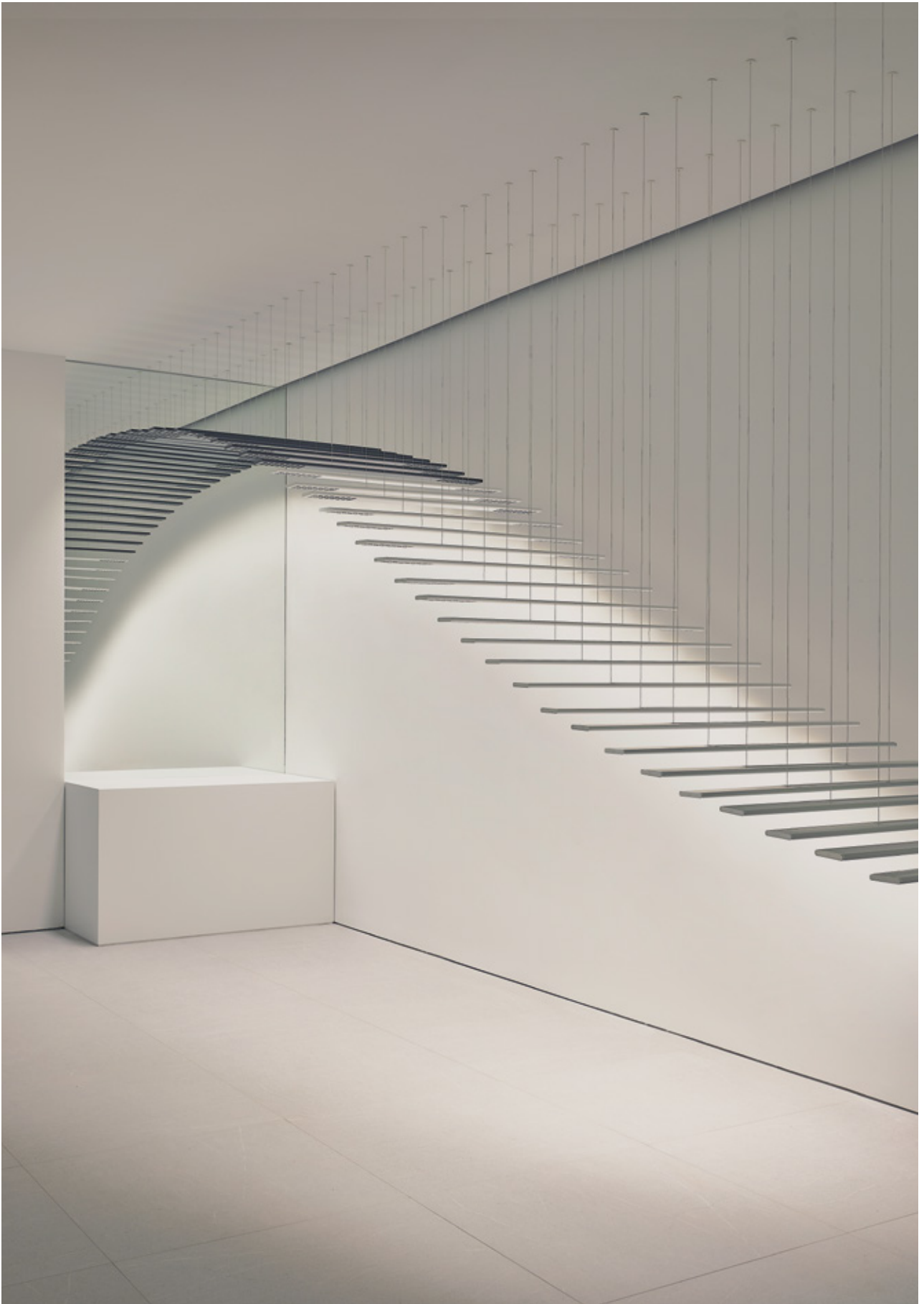











HUMAN CENTRIC LIGHTING

Les modèles *Smart*, à émission indirecte de CCT variable *Tunable White*, permettent la modulation intelligente de la température de couleur de la lumière pour s'adapter au rythme circadien en fonction de l'heure de la journée et favoriser le bien-être et la santé au travail.

Smart models with indirect *Tunable White* variable CCT emission enable the *Smart* modulation of the light's colour temperature to assist with circadian entrainment depending on time of day, promoting well-being and health at work.

VISUAL COMFORT · OFFICE REGULATIONS COMPLIANCE

Workmates est conforme aux réglementations les plus strictes en matière de confort visuel dans les bureaux. Ainsi, dans l'angle de 65° (position normale d'une personne assise au bureau par rapport à la lampe), l'intensité ne dépasse pas 3000 cd/m².

Workmates meets the strictest standards in terms of visual comfort for offices. So at a 65° angle (the normal position of someone sitting at a desk compared with a lamp), the intensity does not exceed 3,000 cd/m².

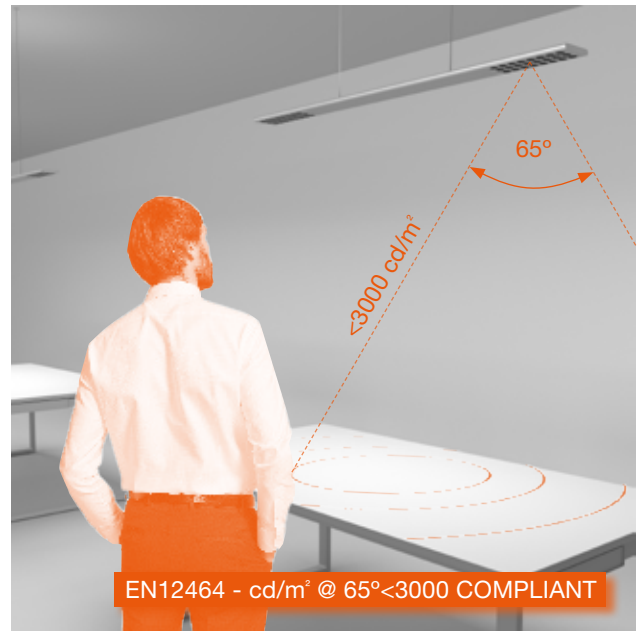
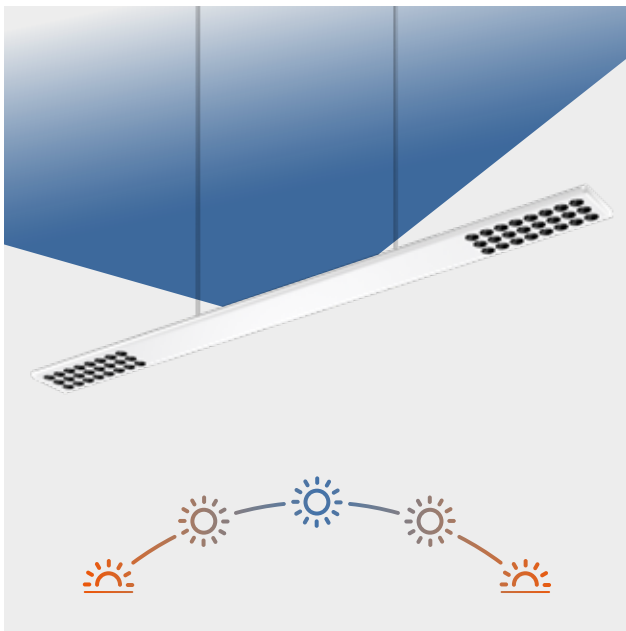



SMART LIGHTING

Avec les systèmes de contrôle *Dali* et sans fil *Casambi*, Workmates dispose de capteurs intégrés ou externes pour activer les scènes d'éclairage souhaitées pour chaque situation. Le tout, en réponse à la détection de présence¹, d'absence¹ ou des seuils de luminosité² souhaités.

With its *Dali* and wireless *Casambi* control systems, Workmates has built-in or external sensors to activate the desired lighting scenarios for each situation. All of it triggered by presence¹ or absence¹ detection, or the desired brightness² thresholds.

DEDICATED LIGHT EMISSION

Chaque modèle Workmates offre les formes de distribution lumineuse nécessaires aux applications requises dans les espaces de travail. Selon le modèle, il existe des distributions *Wide flood*, *ovales* ou *asymmetric* pour l'émission *Down* et *Extra Wide flood* pour l'émission *Up*.

Each Workmates model offers of the necessary light distribution forms for applications that are required in workspaces. Depending on the model, *wide flood*, *oval* or *asymmetric* distributions are available for *Down* emission, and *Extra Wide flood* for *Up* emission.

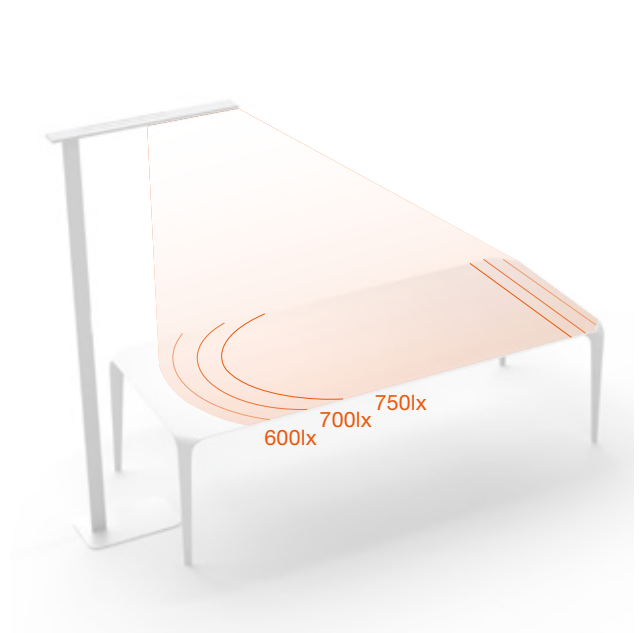
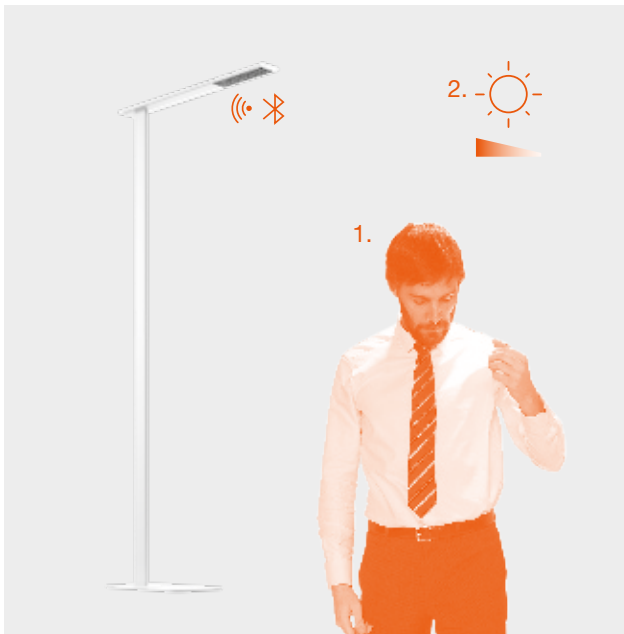









Toutes les lampes de l'écosystème Workmates sont équipées de sources lumineuses LED à *High Efficiency* et *Full Spectrum*. La première permet d'obtenir une excellente efficacité en termes de Lm/W, tandis que l'option *Full Spectrum* permet d'obtenir un indice *NLAS* (*Natural Light Average Secondment*) parfait.

Dans le spectre visible des radiations lumineuses, la lumière naturelle décrit une trajectoire très précise. L'option LED « *Full Spectrum* », disponible pour Workmates, reflète le comportement plus fidèle de la lumière artificielle par rapport au comportement de la lumière naturelle. Elle contribue ainsi à l'amélioration du bien-être humain et au respect des rythmes circadiens naturels de l'éclairage.

All the lights in the Workmates ecosystem are fitted with *High Efficiency* and *Full Spectrum* LED light sources. With the former, you get excellent performance in terms of lm/W, while with the *Full Spectrum* option, you get the perfect *NLAS* (*Natural Light Average Secondment*) index.

Natural light sets a very precise path within the visible light spectrum. The "*Full Spectrum*" LED option, available for Workmates, reflects the most accurate behaviour of artificial light compared with the performance of natural light. It therefore helps improve human well-being and respect the natural schemes of circadian lighting.

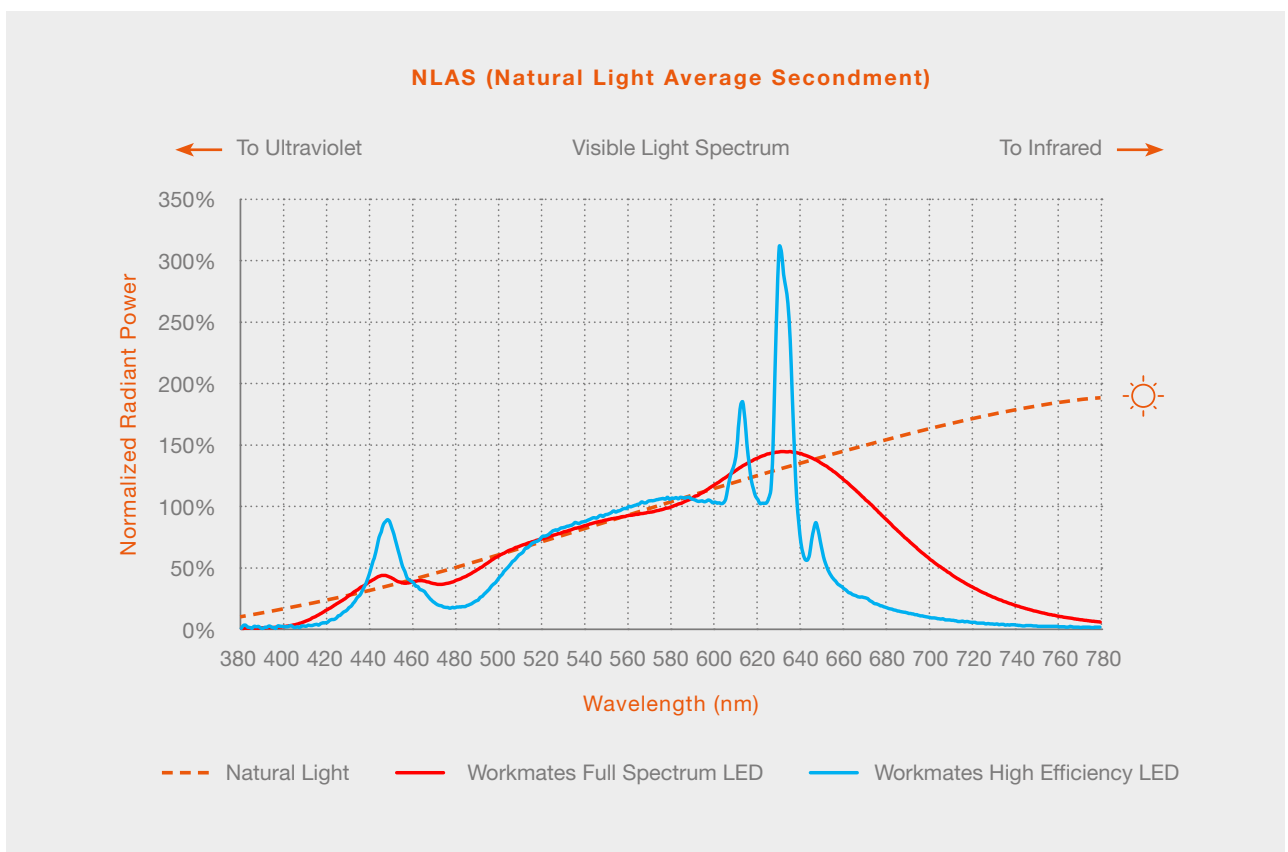



Différentes options de contrôle pour la régulation du WORKMATES.

Different control options for dimming WORKMATES.

Touch Dimming

Les versions au sol ont un clavier capacitif intégré pour contrôler le luminaire.

The floor versions have an integrated capacitive keypad to control the luminaire.

DALI

Protocole standard pour l'intégration avec tout système de contrôle.

Standard protocol for integration with any control system.

CASAMBI

Contrôle avec une application sur tablet ou smartphone (FLOS Control®).

Control through a tablet or smartphone application (FLOS Control®).

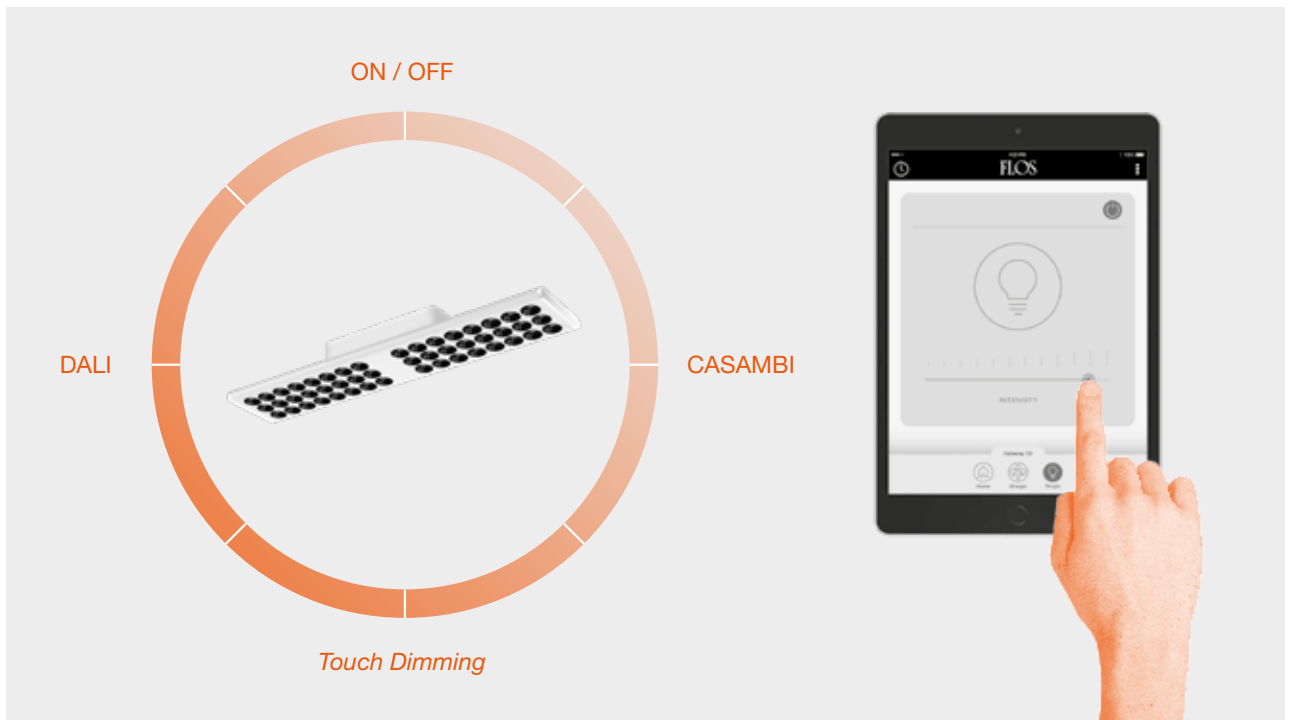

FLOS CONTROL®
BY CASAMBI

L'application FLOS Control® permet de contrôler les appareils d'éclairage du système par groupe, en contrôlant les scènes et la programmation.

The FLOS Control® application allows you to control the system's luminaires as a group, controlling scenes and programming.

Il suffit d'une installation électrique traditionnelle et du Gateway connecté par Bluetooth pour obtenir un contrôle total de l'espace.

With a traditional electrical installation and the Gateway connected by Bluetooth, you obtain total control of the ambience.

Disponible pour IOS et Android

Available for iOS and Android

WORKMATES SURFACE
SMALL



PRELIMINARY
15W

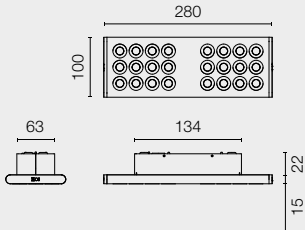

WORKMATES SURFACE
LARGE



PRELIMINARY
22W

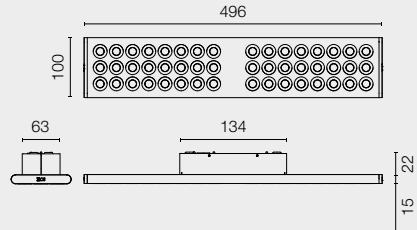

WORKMATES TRACK
SMALL



POWER LED
Up to 15,5W

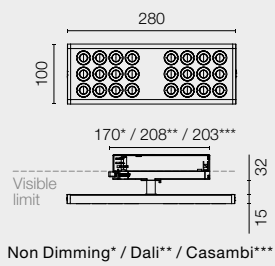

WORKMATES TRACK
LARGE



POWER LED
Up to 22W

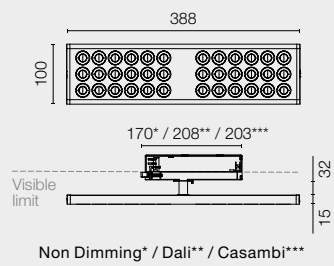

WORKMATES IN-TRACK
SMALL



POWER LED
Up to 15,5W

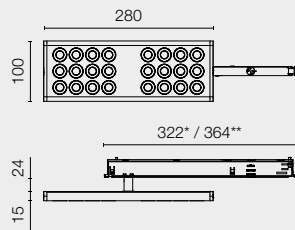

Non Dimming* / Dali**

WORKMATES IN-TRACK
LARGE



POWER LED
Up to 22W

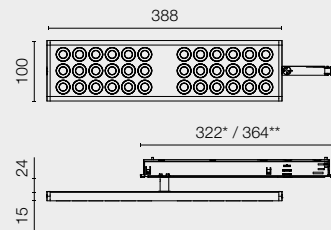

Non Dimming* / Dali**

THE RUNNING MAGNET

WORKMATES SMALL



WORKMATES LARGE



* Voir le chapitre The Running Magnet / Refer to The Running Magnet chapter

WORKMATES SUSPENSION

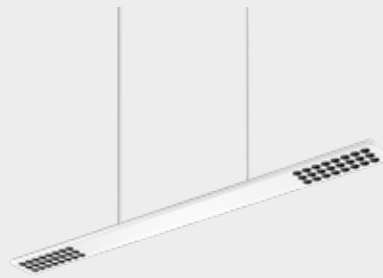

COMING SOON

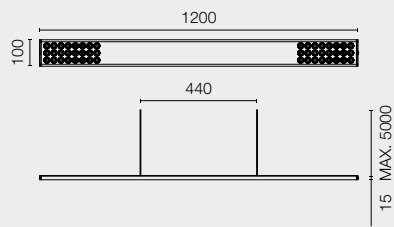

Wide Flood



Oval



Up&Down



Asymmetrical

WORKMATES FLOOR
SINGLE

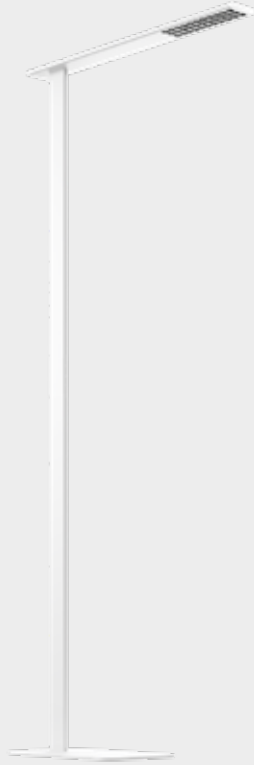

COMING SOON

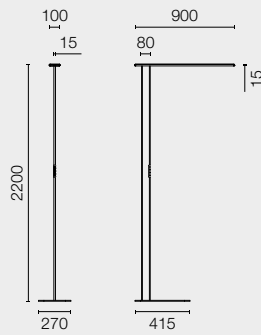

WORKMATES FLOOR
DOUBLE



COMING SOON

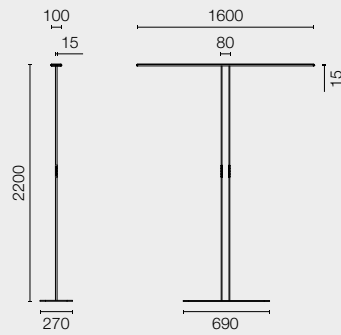

Programme de taille compacte conçu pour éviter l'éblouissement. Variété d'optiques, de tailles et de finitions. Haut niveau de contrôle grâce à son groupe optique breveté.

Compact size program designed to avoid glare. Variety of optics, sizes and finishes. Great control thanks to its patented optical group.

LIGHT SHADOW

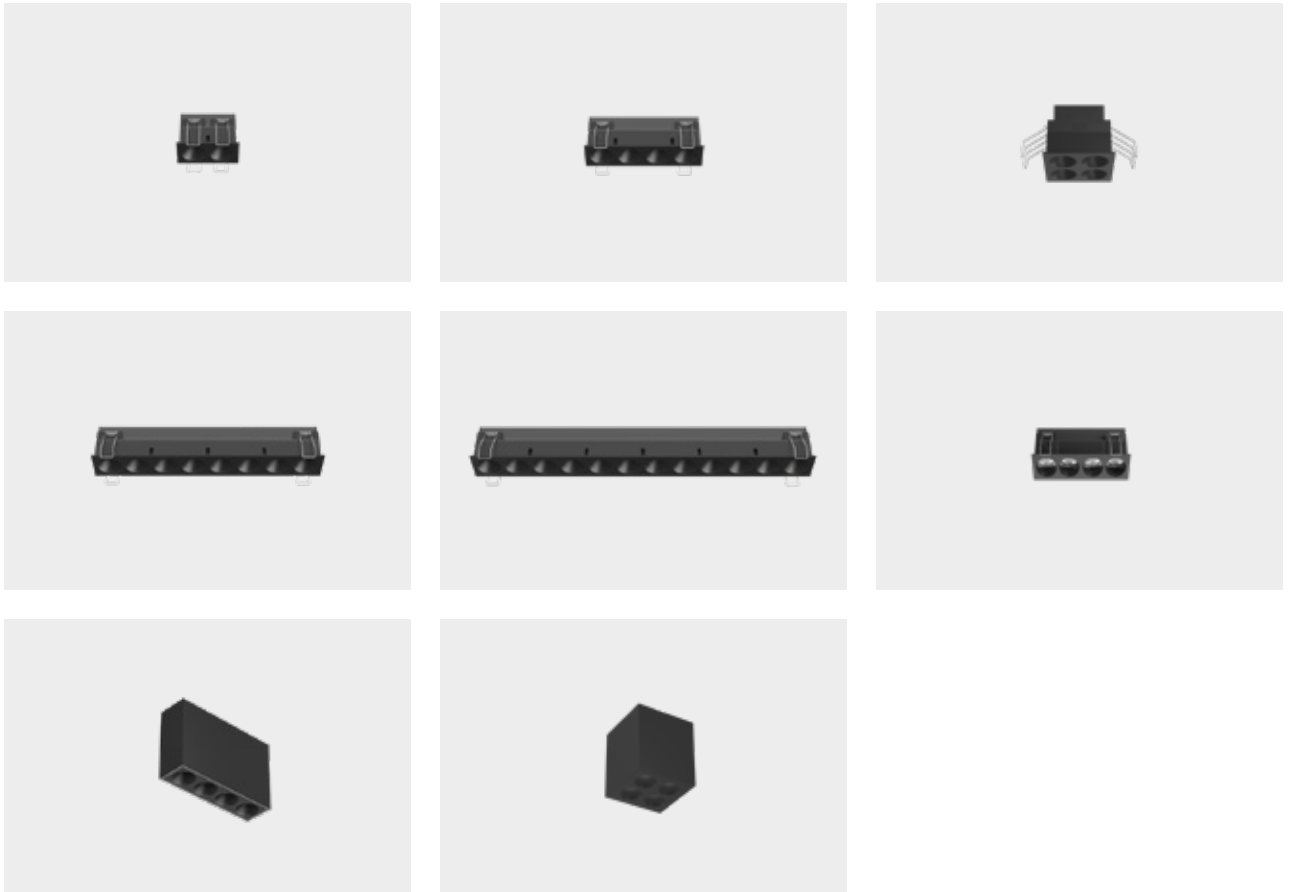





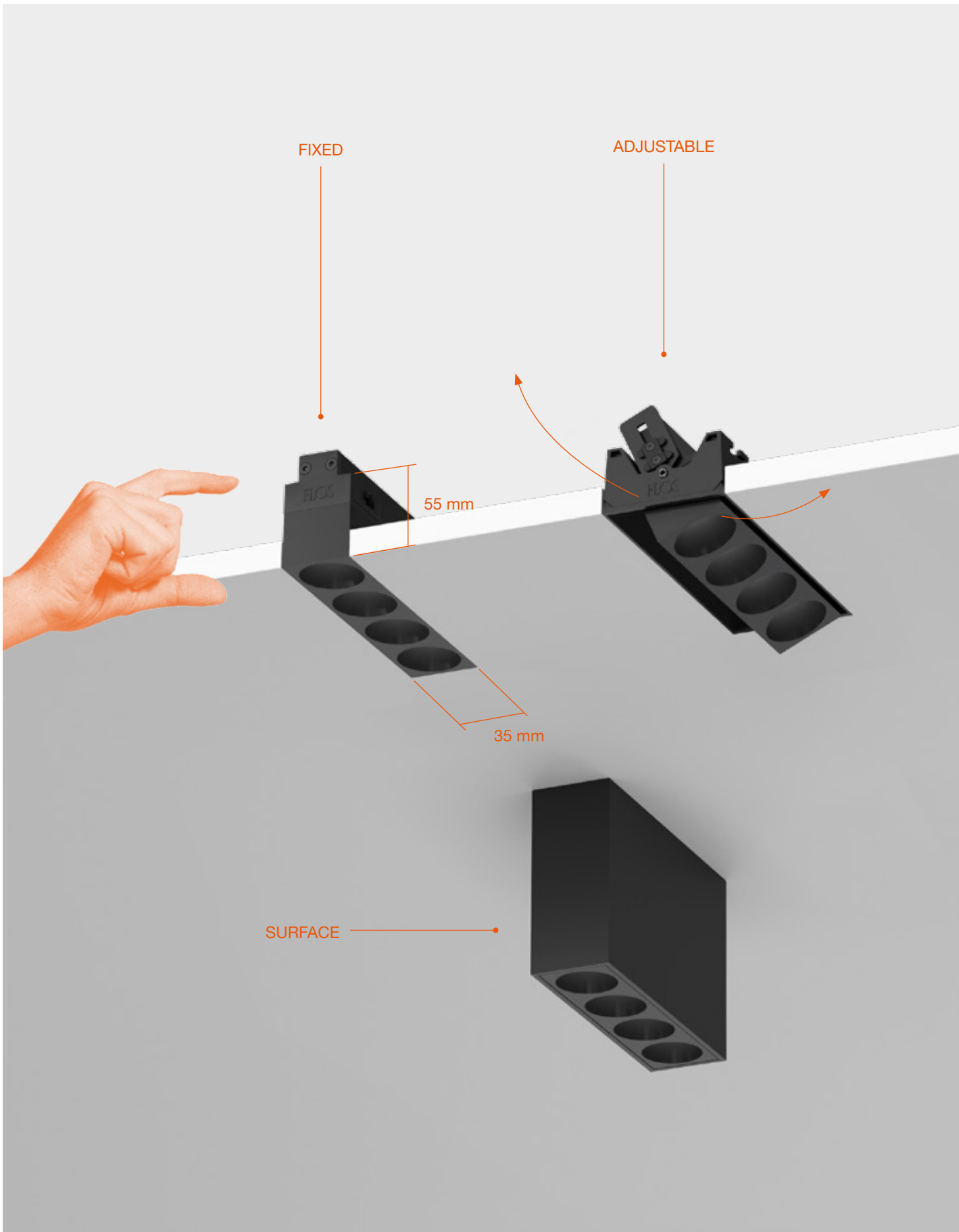

WALL-WASHER

SQUARE

SURFACE
SQUARE

Taille extra compacte qui autorise l'encastrement même en cas de faible espace disponible. La version réglable permet d'extraire le corps principal pour garantir une parfaite intégration avec les éléments architecturaux et de profiter de tout le faisceau.

Extra-compact size which allows embedded integration, even when there is minimum space available. The adjustable version allows the main body to be extracted to guarantee perfect integration with the architecture, and to make the most of the whole beam.

TRADITIONAL TECHNOLOGY

La technologie traditionnelle produit un effet d'éblouissement tandis que le faisceau n'est pas si précis. L'intégration aux éléments d'architecture n'est pas possible.

The traditional technology produces a glare effect while the beam of light is not so precise. Integration with architecture is not achieved.

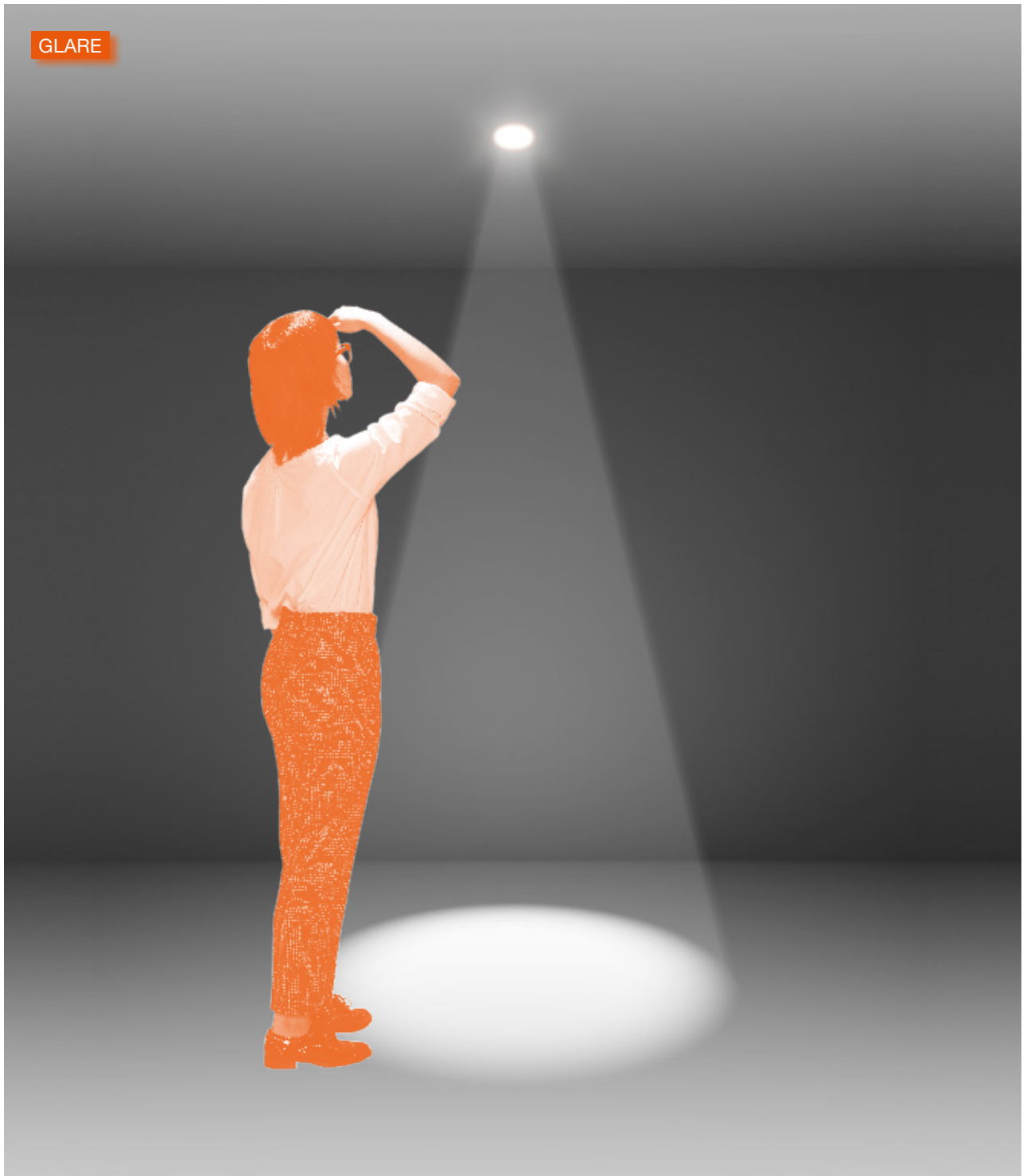

FLOS TECHNOLOGY

Avec la technologie du Light Shadow offrant un angle cut-off de 45 degrés, l'intégration maximale aux éléments d'architecture est combinée avec un faisceau lumineux défini et impeccable et un blindage total, ce qui permet de le placer dans une position quasi zénithale sans être ébloui.

Light Shadow technology thanks to its cut-off of 45 degrees, maximum integration with architecture combines with the impeccable, defined beam of light and total shielding, which allows it to be placed almost in zenithally position with no glare.

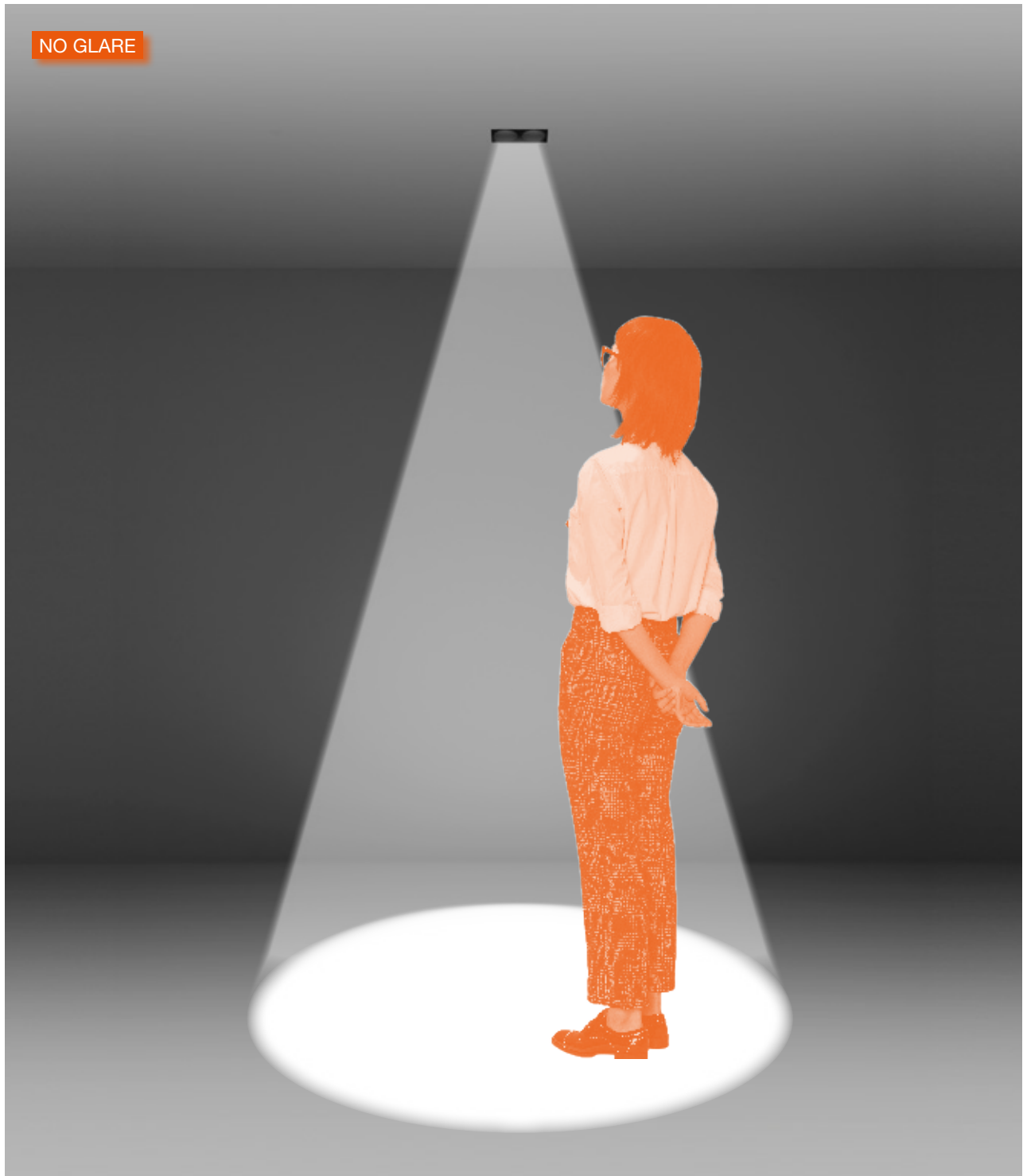

La révolution dans l'éclairage basse éblouissement. Grâce à une solution optique unique brevetée, Light Shadow atteint des angles cut-off extrêmes tout en maintenant un haut rendement et de très faibles dimensions.

The revolution in low glare lighting. Thanks to its patented unique optical solution, Light Shadow reaches extreme cut-off angles without sacrificing high efficiency and very small dimensions.



1 Plaque de LED conçue par FLOS avec des modules LED de dernière génération. Haute qualité et performance.
LED board designed by FLOS with state-of-the-art LED modules. High levels of quality and efficiency.

2 Lentilles développées par FLOS spécialement pour ce produit, qui garantit un contrôle maximum et un faisceau homogène.
Lenses developed by FLOS especially for this product, to guarantee maximum control and a uniform beam.

3 Système breveté de cônes innovants qui offrent un blindage extrême grâce à leur forme de courbe inversée.
Innovative patented cones system that provides extreme shielding thanks to its inverted curve form.

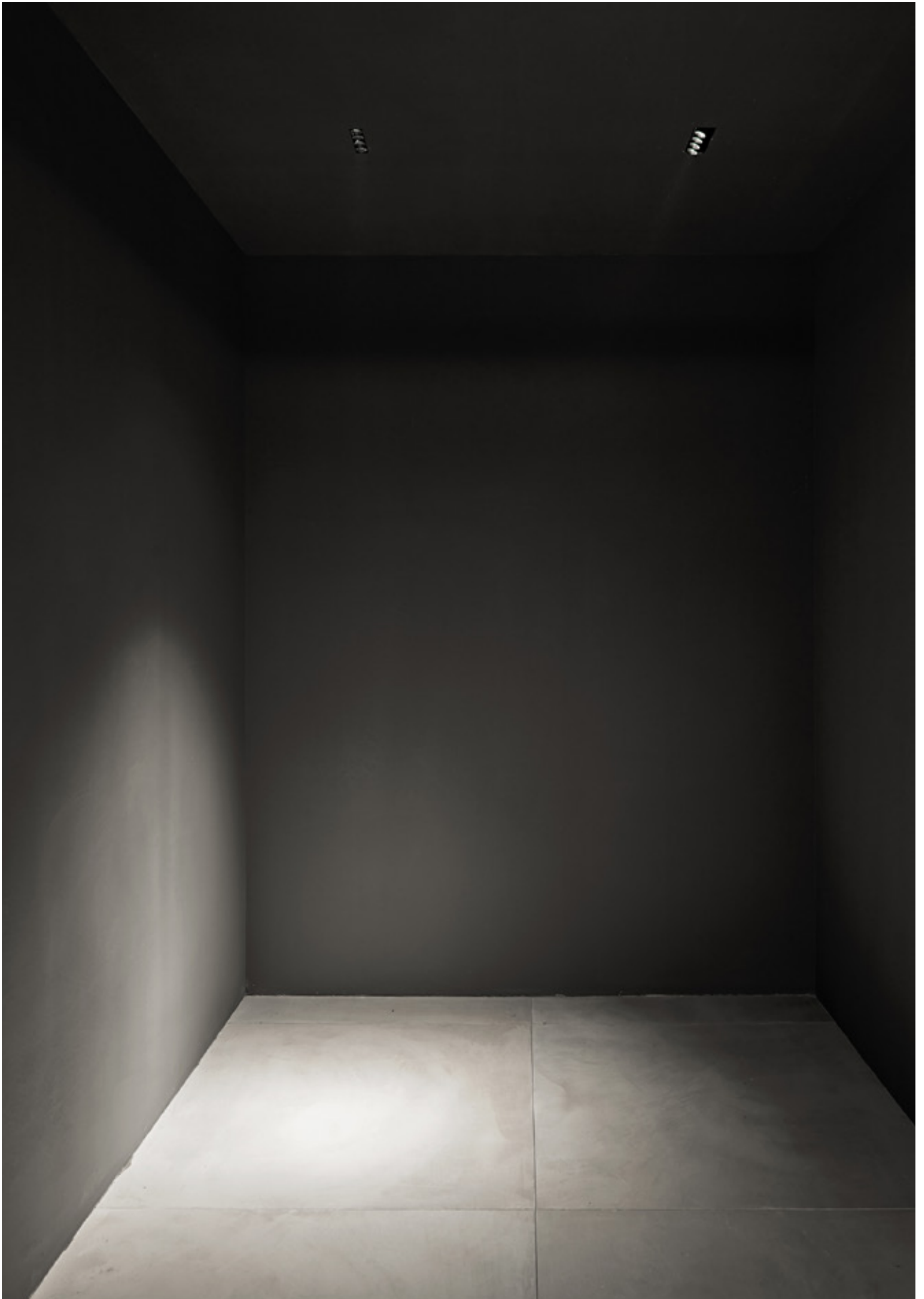



Light Shadow atteint des angles cut-off extrêmes tout en maintenant un haut rendement et de très faibles dimensions.

Light Shadow reaches extreme cut-off angles without sacrificing high efficiency and very small dimensions.

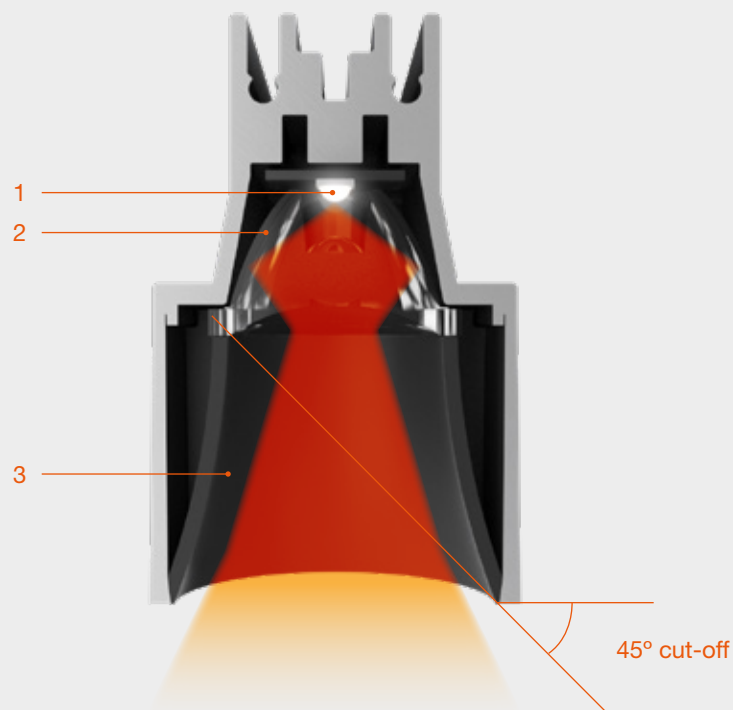

1 Plaque électronique intégrée.
Integrated chip board.

2 Lentille.
Lens.

3 Cône écran.
Screening cone.

L'excellence du confort : UGR inférieur à 10 pour une protection anti-éblouissement exceptionnelle, une distribution lumineuse homogène et une quantité de lux délivrés conforme aux normes industrielles les plus strictes.

The excellence of comfort: UGR below 10 for outstanding glare protection, homogeneity in light distribution and delivered lux compliant to the most strict standards of the industry.

PROJET TYPE

Ambiance 20m x 10m, h. 2,7m.

Version utilisée : Light Shadow 4L Flood Dali dimmable.

Distance entre les appareils : 1,2m

Paramètres d'éclairage :

UGR <10 à partir de n'importe quel point d'observation (UGR <19 valeur minimum normative).

Eclairage moyen : 551 lx

(500 lx valeur minimum normative).

Uniformité obtenue : 0,655

(0,600 valeur minimum normative).

Norme de référence :

UNI-EN 12464-1-2011

PROJECT TYPE

Ambient 20m x 10m, h 2.7m.

Version used: Light shadow 4L Flood Optic Dali dimmable.

Spacing between luminaires: 1.2 m

Technical brightness parameters:

UGR < 10 from any point of observation (UGR < 19 standard minimum value).

Average brightness: 551 lx

(500 lx standard minimum value).

Uniformity obtained: 0.655

(0.600 standard minimum value).

Reference standard:

UNI-EN 12464-1:2011

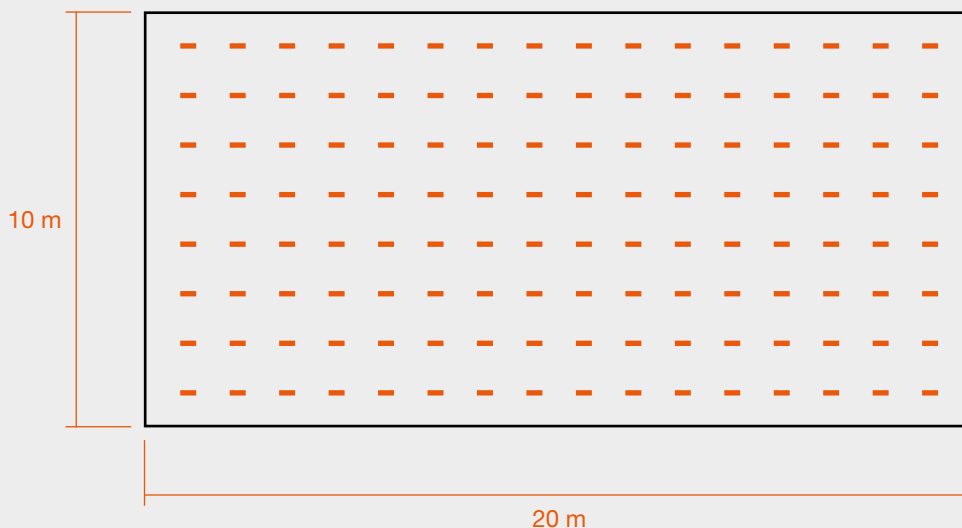

NO GLARE

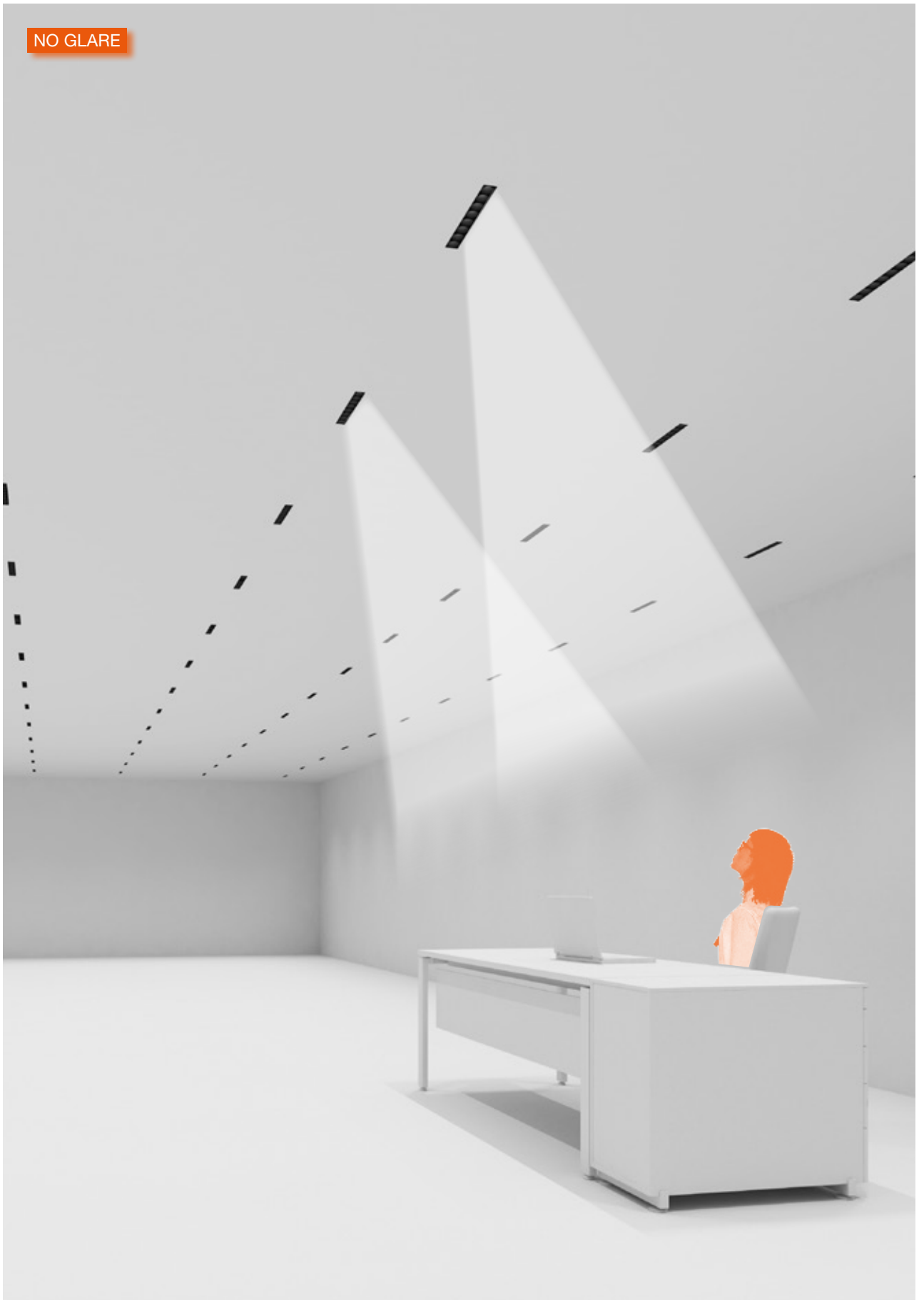





Light Shadow est également disponible pour installation magnétique sur le rail Running Magnet exclusif de Flos : flexibilité et adaptabilité à tout moment. Voir les détails de la collection Magnet dans les catalogues Flos.

Light Shadow is also available for magnetic installation in Flos exclusive The Running Magnet track: flexibility and adaptability at any time. See Flos catalogues for complete details about The Running Magnet collection.

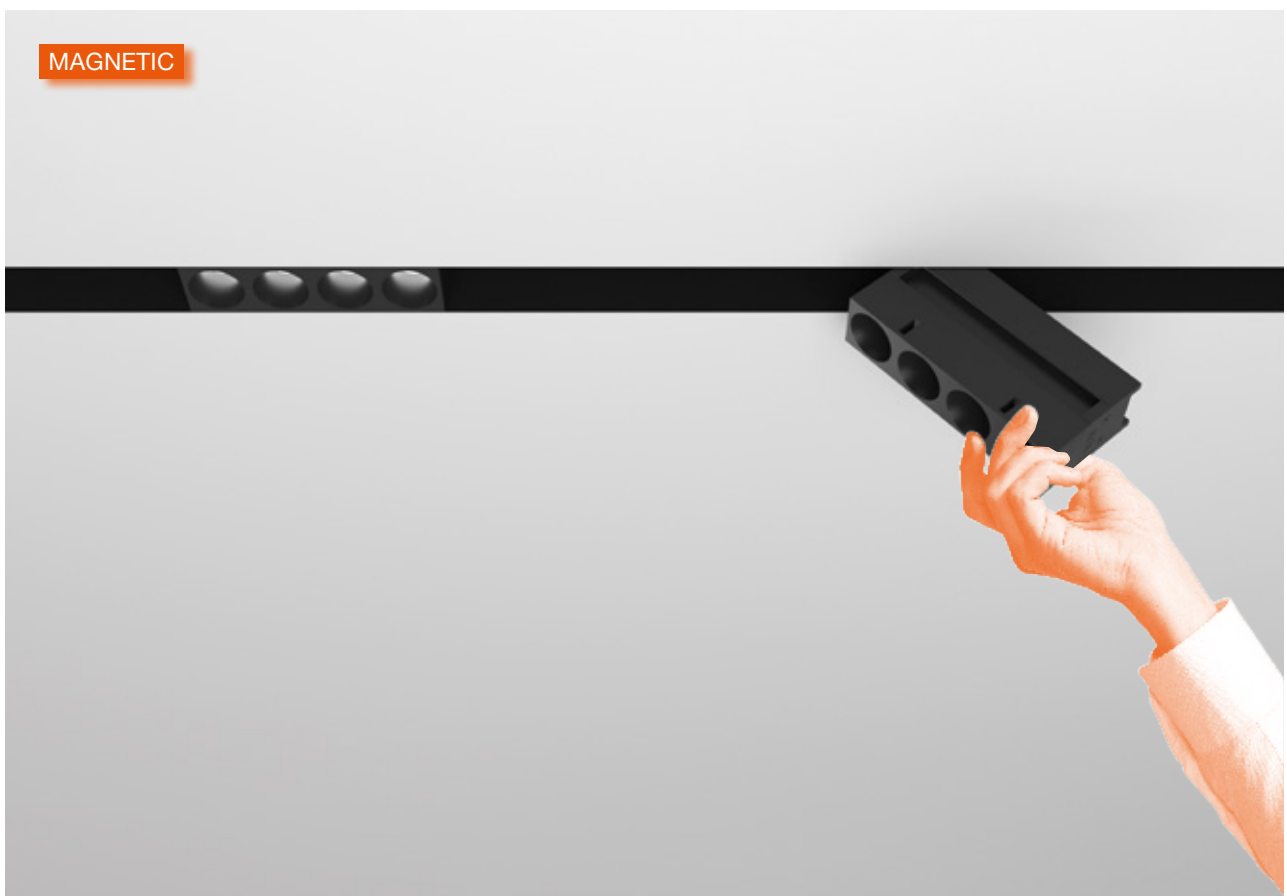

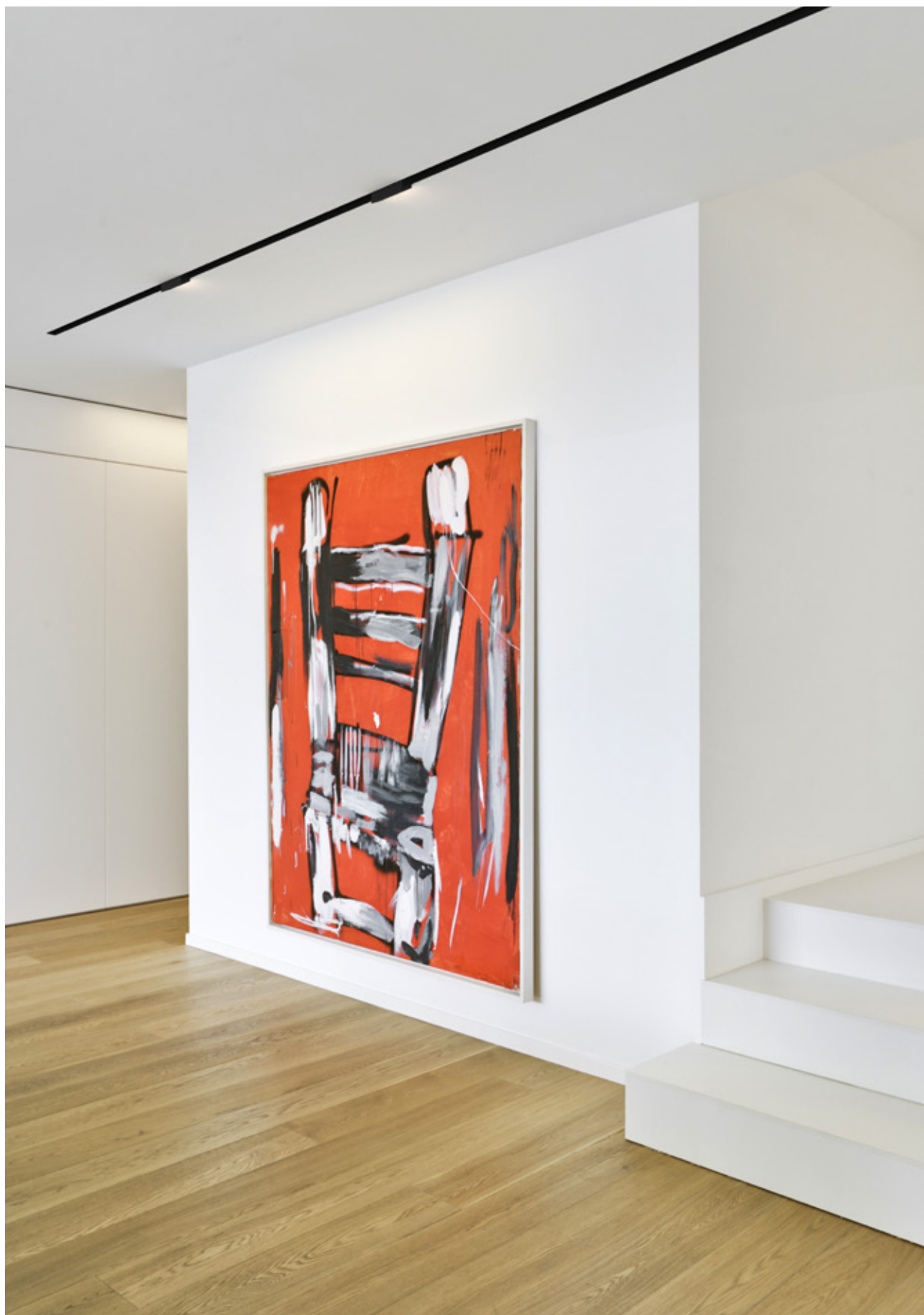

Effet de lumière douce et contrôlée, développé pour éclairer uniformément tout plan vertical. Le nouveau module wall-washer complète le programme avec une solution extrêmement professionnelle qui laisse intact le grand confort visuel qui distingue le programme.

Soft and controlled lighting effect, developed to uniformly light up any vertical plane. The new wall-washer module completes the program with an extremely professional solution that preserves the high visual comfort that characterizes the program.

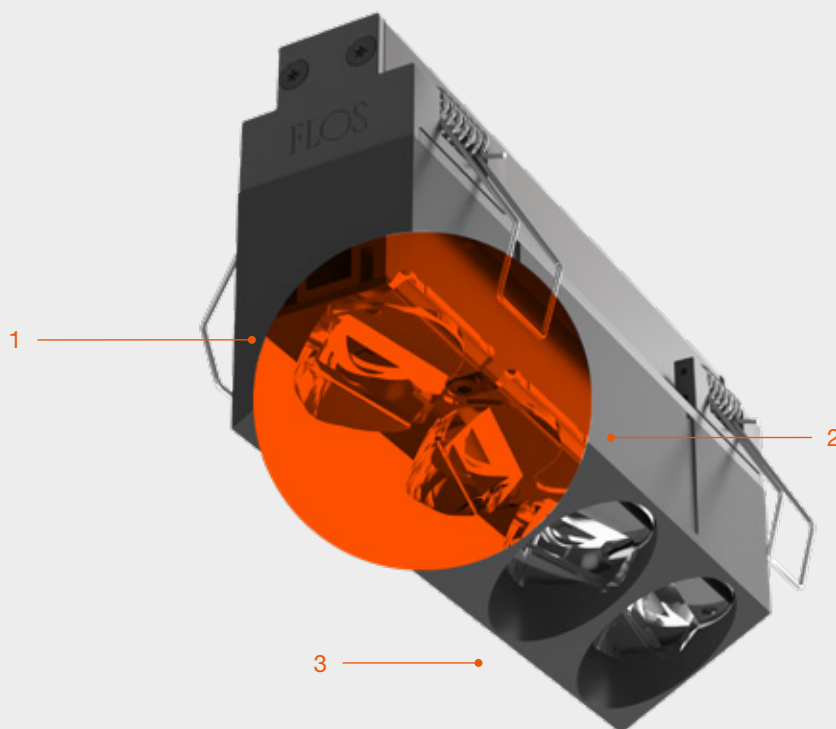

1 Lentille asymétrique spéciale, conçue pour une distribution verticale parfaite de l'émission lumineuse.

Special asymmetric lens, designed for a perfect vertical distribution of the light emission.

2 Lentilles pivotées individuellement pour couvrir une plus grande surface d'éclairage et augmenter l'homogénéité de la lumière.

Individually rotated lenses in order to cover a larger lighting surface and to increase the homogeneity of the light.

3 Écran intégré pour éviter les effets d'éblouissement indésirables.

Integrated screen that avoids undesirable glare effects.

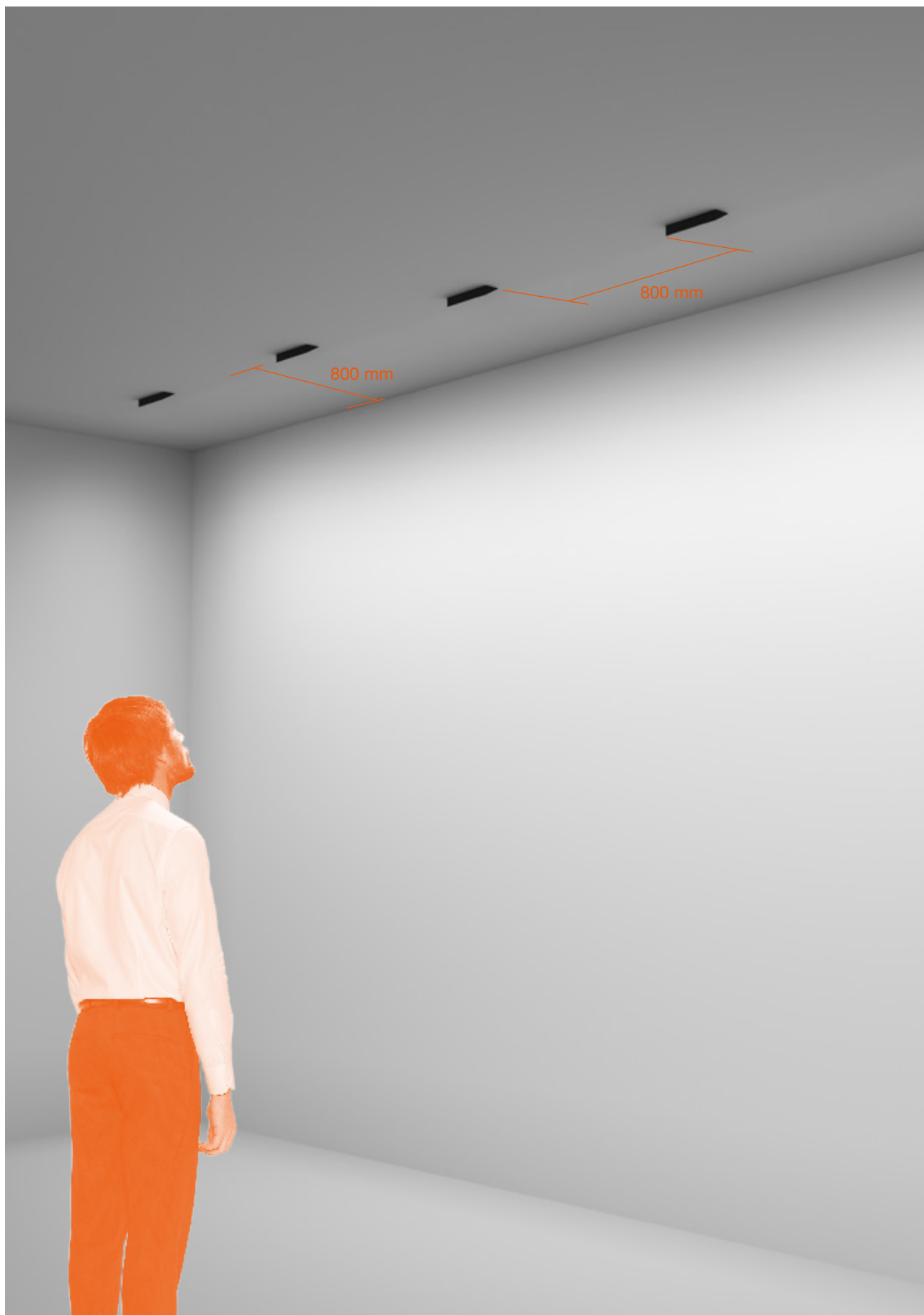

FIXED
TRIM / NO TRIM
2 SPOTS



POWER LED
3,5W x SPOT



FIXED
TRIM / NO TRIM
4 SPOTS



POWER LED
2,7W x SPOT

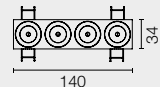
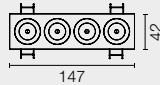

FIXED
TRIM / NO TRIM
4 SPOTS SQUARE



POWER LED
2,7W x SPOT

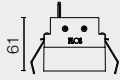
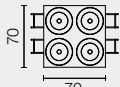
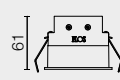
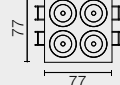

FIXED
TRIM / NO TRIM
8 SPOTS

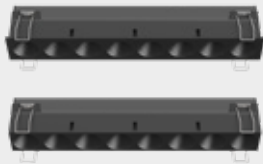

POWER LED
2,7W x SPOT

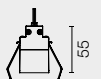
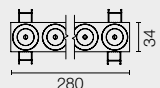
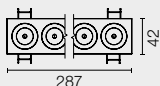

FIXED
TRIM / NO TRIM
12 SPOTS

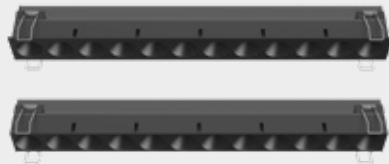

POWER LED
2,7W x SPOT

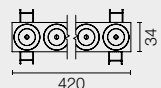
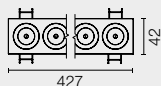

LIGHT SHADOW FIXED / ADJUSTABLE / SURFACE

Internal Finish



External Plate Finish



LIGHT SHADOW WALL-WASHER

External Plate Finish



LIGHT SHADOW SURFACE

Box Finish

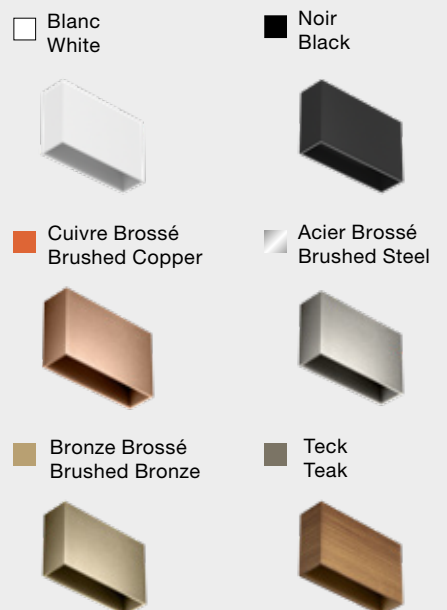

Spot



Medium



Flood



Wide Flood



Wall-Washer

ADJUSTABLE TRIM / NO TRIM
2 SPOTS



POWER LED
3,5W x SPOT

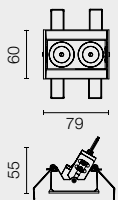
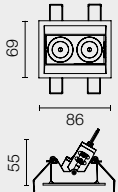

ADJUSTABLE TRIM / NO TRIM
4 SPOTS

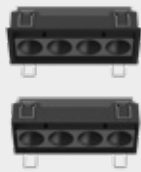

POWER LED
2,7W x SPOT

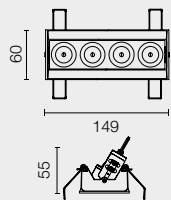
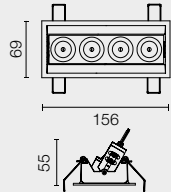

ADJUSTABLE TRIM / NO TRIM
8 SPOTS



POWER LED
2,7W x SPOT

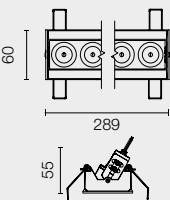
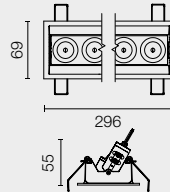

ADJUSTABLE TRIM / NO TRIM
12 SPOTS



POWER LED
2,7W x SPOT

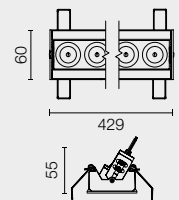
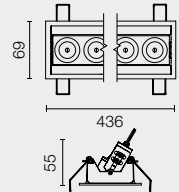

WALL-WASHER TRIM / NO TRIM
4 SPOTS



POWER LED
2,7W x SPOT

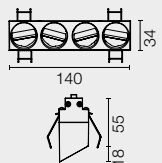
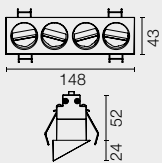

SURFACE 4 SPOTS



POWER LED
2,7W x SPOT

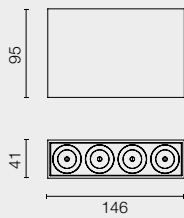

SURFACE SQUARE 4 SPOTS



POWER LED
2,7W x SPOT

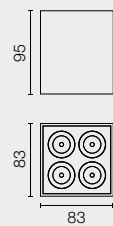

LIGHT SHADOW
*compatible module for
The Running Magnet



POWER LED
2,7W x SPOT

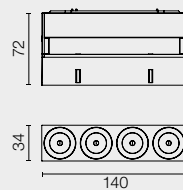

LIGHT SHADOW W-W
*compatible module for
The Running Magnet



POWER LED
2,7W x SPOT

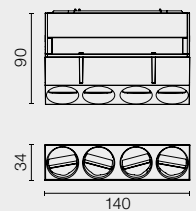

*Voir les modules compatibles pour la collection The Running Magnet /
See compatible modules for The Running Magnet collection

LIGHT SHADOW
LIGHT SHADOW
LIGHT SHADOW
LIGHT SHADOW
LIGHT SHADOW
LIGHT SHADOW
LIGHT SHADOW
LIGHT SHADOW

U
O
T
S

O
R
P

LIGHT SHADOW
LIGHT SHADOW
LIGHT SHADOW
LIGHT SHADOW
LIGHT SHADOW

Programme de downlights révolutionnaire, développé pour contrôler l'éblouissement dans d'innombrables applications. Le système optique exclusif et breveté a été appliqué à de multiples largeurs de faisceaux faites sur mesure pour des applications spécifiques commwwwe dans des bureaux, des boutiques ou des maisons.

Revolutionary downlights program developed to control glare in countless applications. The unique patented optical system has been applied to multiple custom-made beamwidths for specific applications such as offices, shops and homes.

LIGHT SHADOW DOTS & PRO

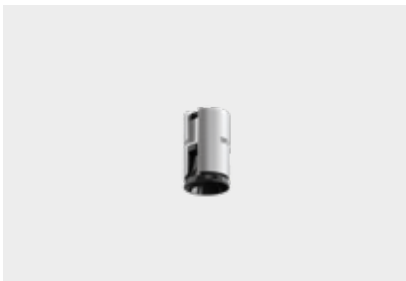







PRO Ø90
NO TRIM
FIXED / ADJUSTABLE

PRO Ø90
NO TRIM
WALL-WASHER



PRO Ø90
TRIM
FIXED / ADJUSTABLE

PRO Ø90
TRIM
WALL-WASHER

Une toute nouvelle approche de l'éclairage architectural. Il amène le contrôle de l'éblouissement à un niveau supérieur où les valeurs d'efficacité optique sont extrêmement élevées grâce à l'utilisation de technologies de dernière génération et où la qualité de la lumière atteint des standards encore plus élevés et plus raffinés.

A completely new approach to architectural lighting. It takes glare control to the next level. Optical efficiency values are extremely high thanks to the use of the latest generation technologies and the light quality reaches even higher and more refined standards.

LIGHT SHADOW DOTS

Le plus petit downlight du programme. Un diamètre de 30 mm et une profondeur d'encastrement extrêmement réduite sont associés à un système optique complexe qui assure un blindage extrême de la source grâce à la forme inversée des cônes cut-off qui la caractérisent.

The smallest downlight in the range. A 30 mm diameter and an extremely reduced recess depth are combined with a complex optical system that provides extreme shielding of the source thanks to the inverted shape of the cut-off cones that characterize it.

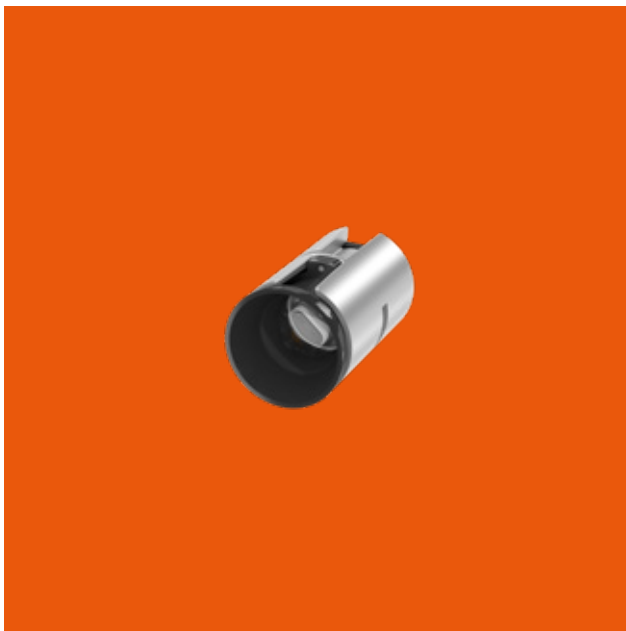

1

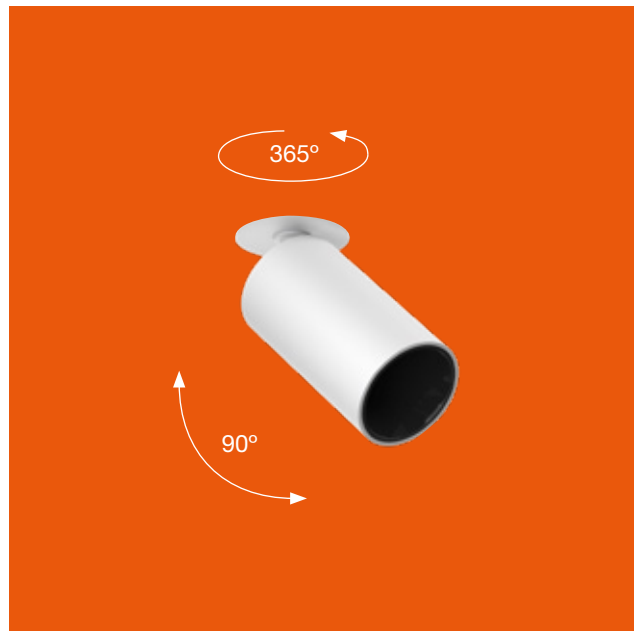

2

LIGHT SHADOW PRO

L'évolution naturelle du Light Shadow Dots. Les nouvelles versions Pro sont le résultat d'une recherche optique minutieuse. Elles offrent une efficacité extrêmement élevée malgré leur petite taille et leur corps compact.

The natural evolution from the Light Shadow Dots. The new Pro versions are the result of careful optical research. They offer extremely high effectiveness despite their small size and compact body.



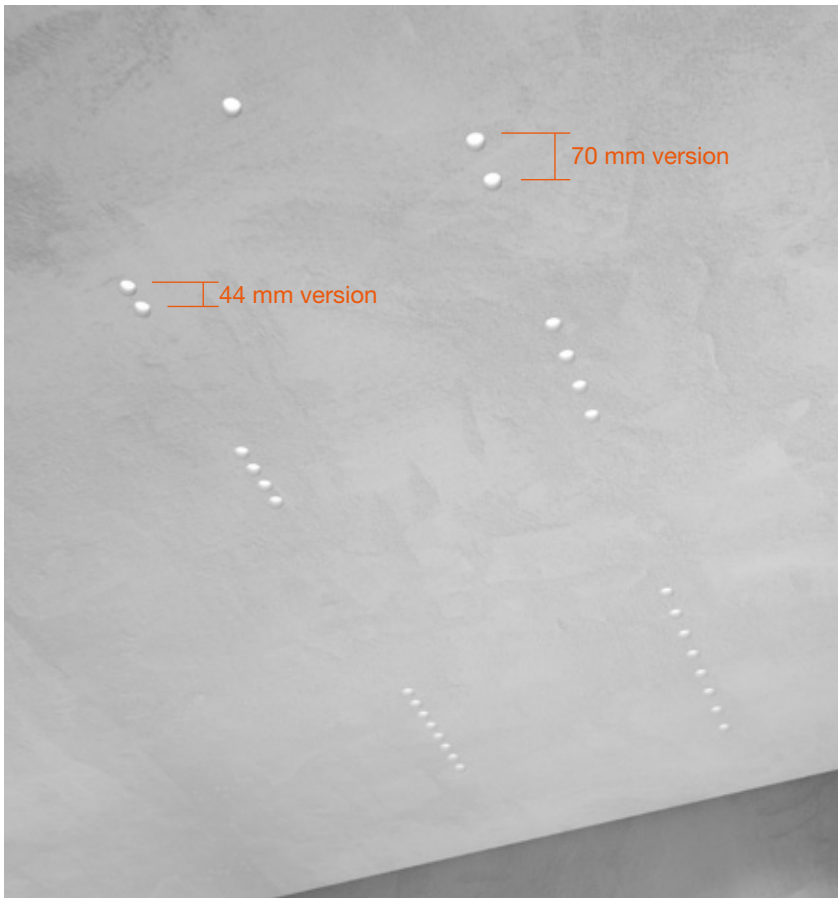

Light Shadow Dots est disponible en versions TRIM et NO TRIM. L'option sans cadre permet une intégration parfaite dans les plafonds en plâtre dont le résultat est un luminaire affleurant et intégré au plafond. En outre, il est possible de l'installer par modules linéaires avec deux options d'espacement entre les points.

Light Shadow Dots is available in TRIM and NO TRIM versions. The frameless option allows perfect integration into plaster ceilings, resulting in a luminaire that is completely flush and integrated into the ceiling. In addition, it is possible to arrange it in modular in-line presentations, with two options of spacing between the points.



Les cadres de pré-montage No Trim de Light Shadow Dots Fixed et Push sont compatibles et peuvent être installés de manière continue, en maintenant l'espacement. Ainsi, lorsque les modèles Push sont encastrés, ils ne se distinguent pas des versions Fixed.

Light Shadow Dots Fixed and Push No Trim pre-installation frames are compatible and can be installed continuously, maintaining the spacing. In this way, when the Push models are in recessed position, they are indistinguishable from the Fixed versions.



Restaurant Het Vliegend
Tapijt, Belgium





Le Light Shadow Pro profite des avantages d'une lentille innovante en silicone qui permet un contrôle extrême du faisceau en plus d'une efficacité absolue, une résistance à la chaleur et une distribution lumineuse de qualité maximale.

Light Shadow Pro exploits the benefits of an innovative silicone lens that allows absolute beam control with an extreme efficiency, heat resistance and maximum quality light distribution.



FLOS TECHNOLOGY

Le kit optique disponible comprend 5 largeurs de faisceau différentes, chacune étant développée pour une application spécifique. Qu'il s'agisse de faisceaux intenses ou d'effets de lumière diffuse, le contrôle optique est toujours exceptionnel et la lumière parasite est totalement absente.

The available optical kit includes 5 different beamwidths. Each one of them is developed for a specific application. The optical control is always exceptional and the stray light is totally absent whether for intensive beams or diffuse lighting effects.







Grâce à la solution optique exclusive et brevetée, le Light Shadow Pro contrôle des angles cut-off extrêmes sans compromettre la haute efficacité et l'incroyable polyvalence du produit.

Thanks to the unique patented optical solution, Light Shadow Pro controls extreme cut-off angles without altering the high efficiency and incredible versatility of the product.

UGR<10

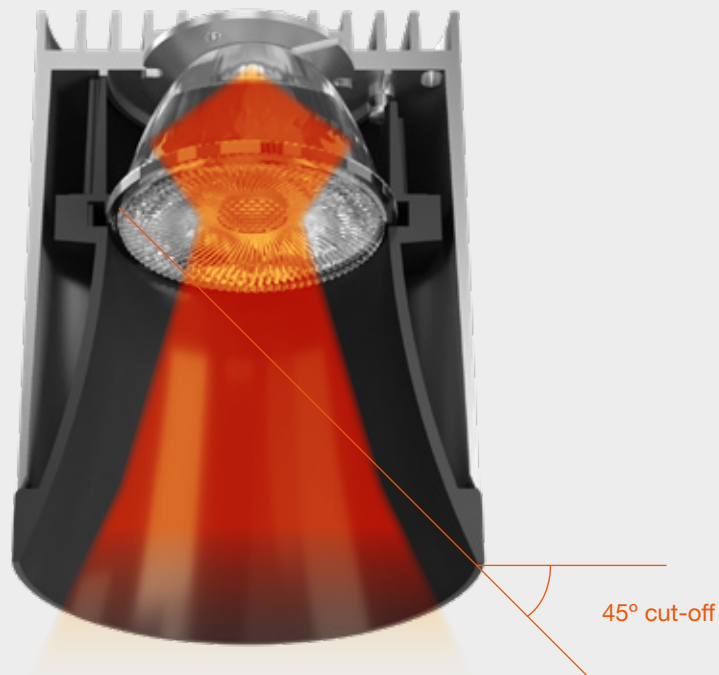

Lentille à double foyer développée par FLOS spécifiquement pour ce produit. Elle assure un contrôle optique maximal et une homogénéité exceptionnelle du faisceau lumineux.

Dual-focus lens developed by FLOS specifically for this product. It ensures maximum optical control and exceptional light beam homogeneity.

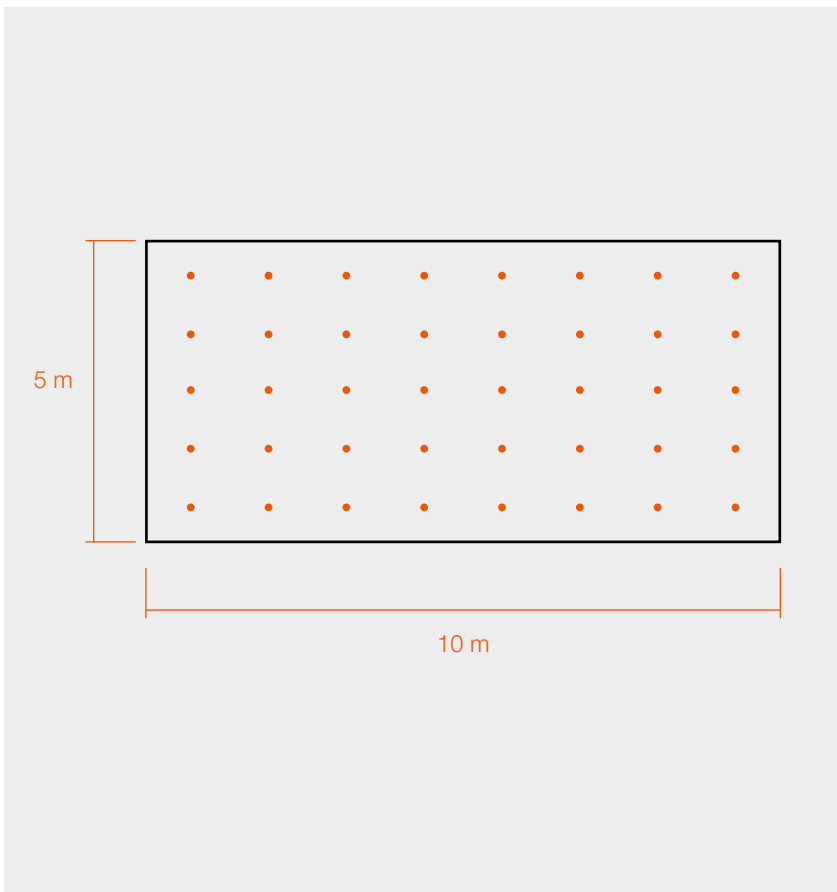
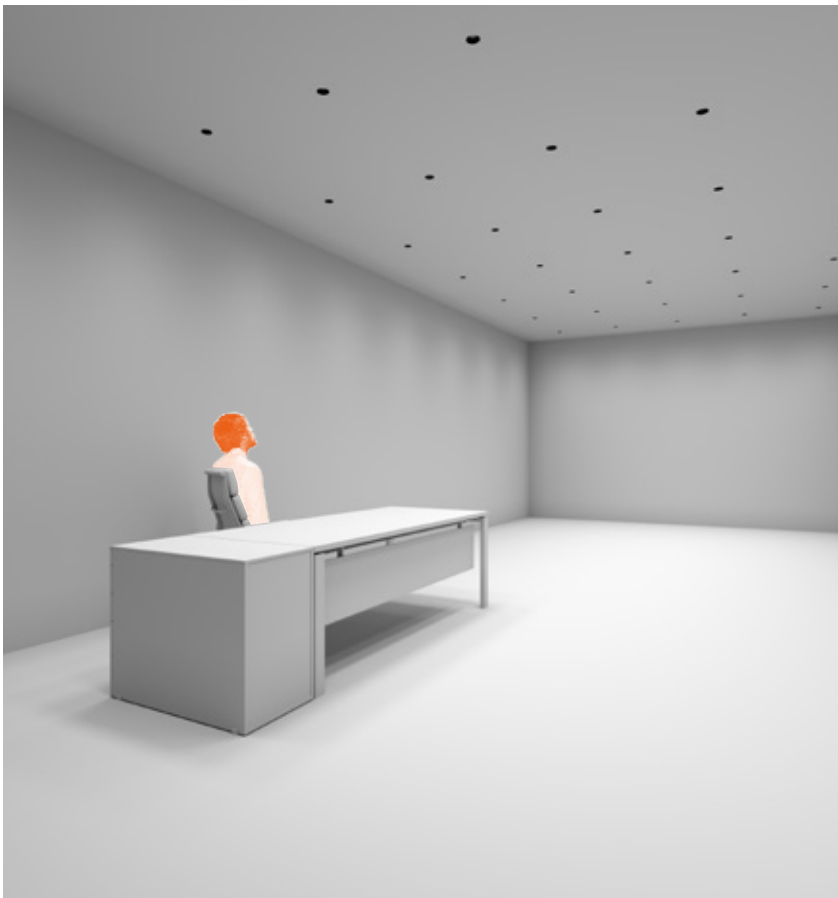

PROJET TYPE

Ambiance 5 m x 10 m, h 3 m.

Version utilisée : Light shadow PRO 60 Flood Dali.

Distance entre les appareils : 1,2m

Paramères d'éclairage :

UGR <10 à partir de n'importe quel point d'observation (UGR <19 valeur minimum normative).

Eclairage moyen : 1045 lx

Uniformité obtenue : 0,68

(0,600 valeur minimum normative).

Norme de référence :

UNI-EN 12464-1-2011

PROJECT TYPE

Ambient 5 m x 10 m, h 3 m.

Version used: Light shadow PRO 60 Flood Optic.

Spacing between luminaries: 1.2 m

Technical brightness parameters:

UGR < 10 from any point of observation (UGR < 19 standard minimum value).

Average brightness: 1045 lx

Uniformity obtained: 0.68

(0.600 standard minimum value).

Reference standard:

UNI-EN 12464-1:2011







	Différentes options de contrôle pour la régulation du LIGHT SHADOW DOTS & PRO, toutes disponibles pour une installation intégrée ou en surface.	Different control options for dimming LIGHT SHADOW DOTS & PRO, all available for remote recessed or surface installation.
PUSH DIMMING	Contrôle à travers un dispositif de régulation.	Control trough a simple pushbutton.
DALI	Protocole standard pour l'intégration avec tout système de contrôle.	Standard protocol for integration with any control system.
1-10V	Contrôle à distance en broadcasting (variation de tous les luminaires dans un seul groupe).	Broadcasting remote control (dimming of all the luminaires in a single group).
CASAMBI	Contrôle broadcast avec une application sur tablet ou smartphone (FLOS Control®).	Broadcast control through a tablet or smartphone application (FLOS Control®).

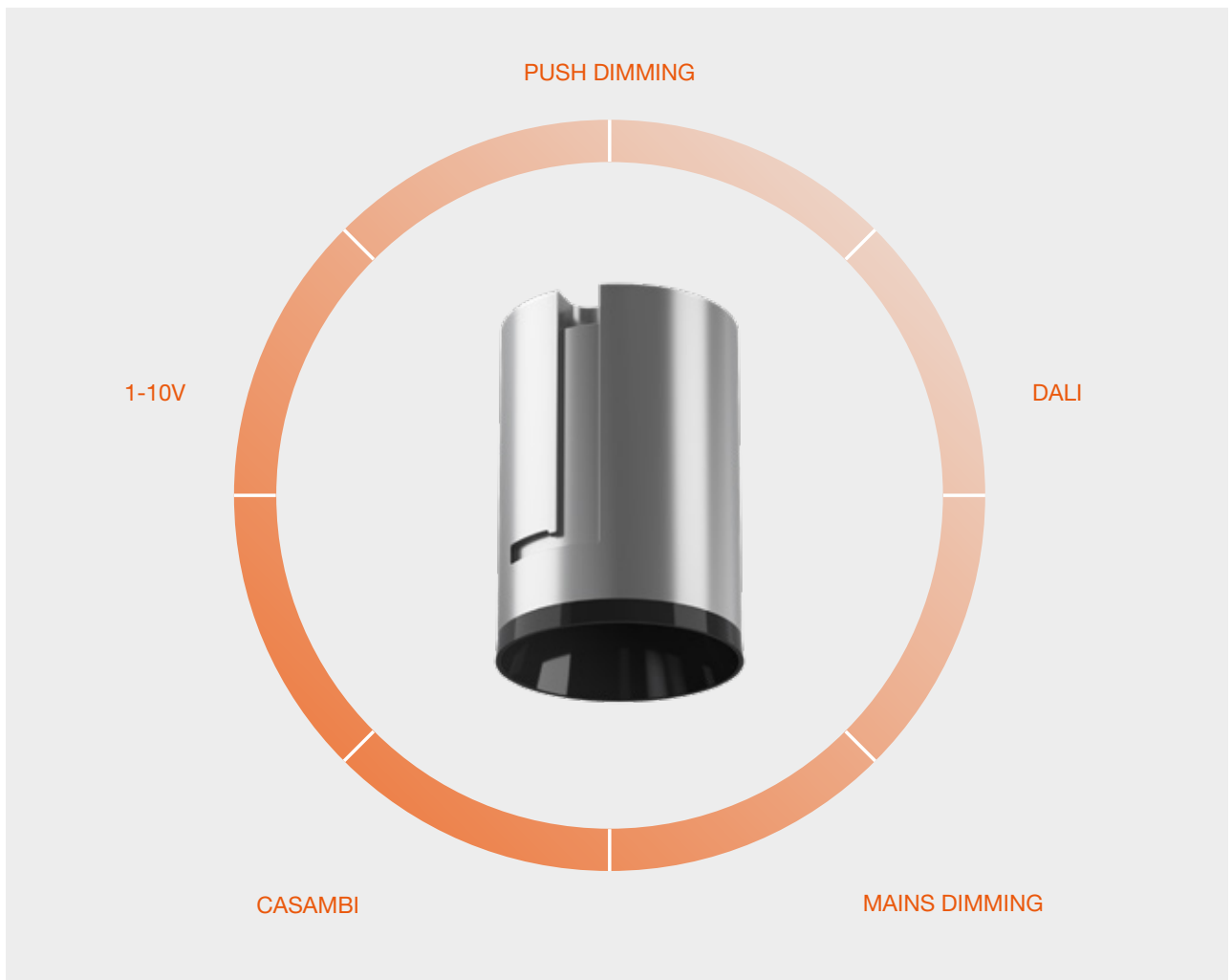

DOTS Ø30
FIXED



POWER LED
UP to 2,7W

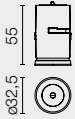

PRO Ø45
FIXED



LED ARRAY
8,5W

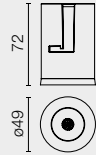

PRO Ø60
FIXED



LED ARRAY
UP to 15W

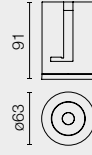

PRO Ø90
FIXED



LED ARRAY
UP to 22W

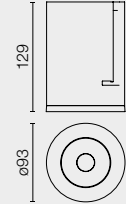

DOTS Ø30
PUSH



POWER LED
UP to 2,7W

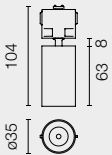

PRO Ø45
PUSH



LED ARRAY
8,5W

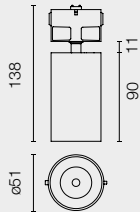

PRO Ø60
ADJUSTABLE



LED ARRAY
10,5W

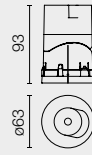

PRO Ø90
ADJUSTABLE



LED ARRAY
UP to 18W

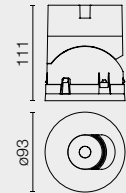

PRO Ø45
SURFACE



LED ARRAY
11W

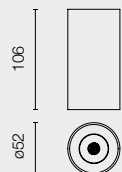

PRO Ø60
SURFACE



LED ARRAY
15W



PRO Ø90
WALL-WASHER



LED ARRAY
18W

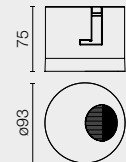

Rear Finish

Light Shadow Pro&Dots Push

40 Blanc
40 White

14 Noir
14 Black



External Finish

Light Shadow Dots Push / Light Shadow Pro Push & Surface

40 Blanc
40 White

14 Noir
14 Black

EQ Cuivre Brossé
EQ Brushed Copper

ER Acier Brossé
ER Brushed Steel

ES Bronze Brossé
ES Brushed Bronze

TK Teck
TK Teak



Internal Finish

40 Blanc
40 White

14 Noir
14 Black

ER Acier
ER Steel

ES Bronze
ES Bronze

EQ Cuivre
EQ Copper



Super Spot



Spot



Medium



Flood



Wide Flood



Wall-Washer

ECLECTIC

ECLEC

E

TIC

CLEC

ECLECTIC

Luminaire d'intérieur, encastrable au plafond, à conception modulaire en suivant les principes du design et de l'économie circulaire. Commercialisé comme luminaire complet, il se divise en modules qui définissent ses caractéristiques. Les modules sont aussi proposés en pièces détachées.

Recessed in ceiling, indoor luminaire. A product with a modular concept that follows the principles of circular design and economy. Marketed as a complete luminaire, it can be broken down into modules that define its features. These modules are also offered as spare parts.

ECLECTIC

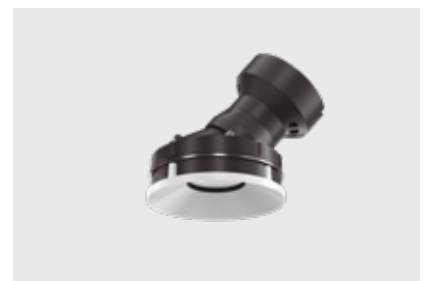
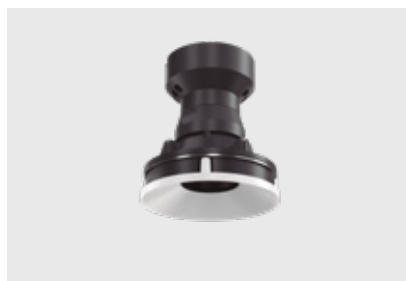
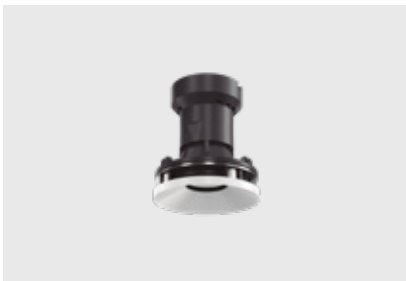

Gamme Eclectic disponible en deux tailles (Ø70 et Ø90). Chaque taille a deux modèles (Fixe et Réglable). Proposé avec deux types de préca-dres d'installation (Trim et No Trim), et 3 façades (Cone, Flat et Soft).

The Eclectic range comprises two sizes (Ø70 and Ø90) for which two models are available (fixed and adjustable). Two installation pre-frames (Trim and No Trim) and 3 style modules (Cone Flat and Soft) are available.

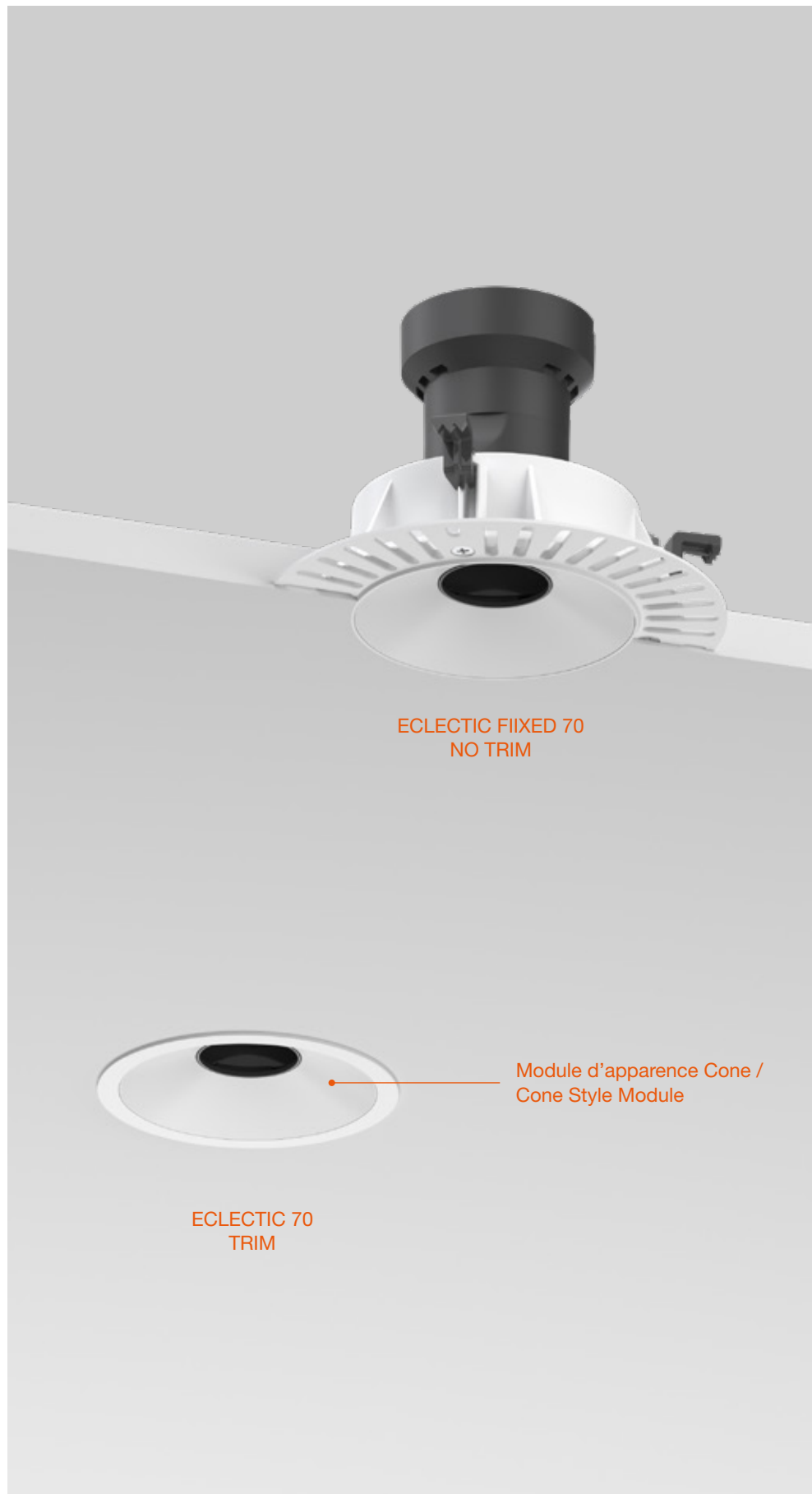

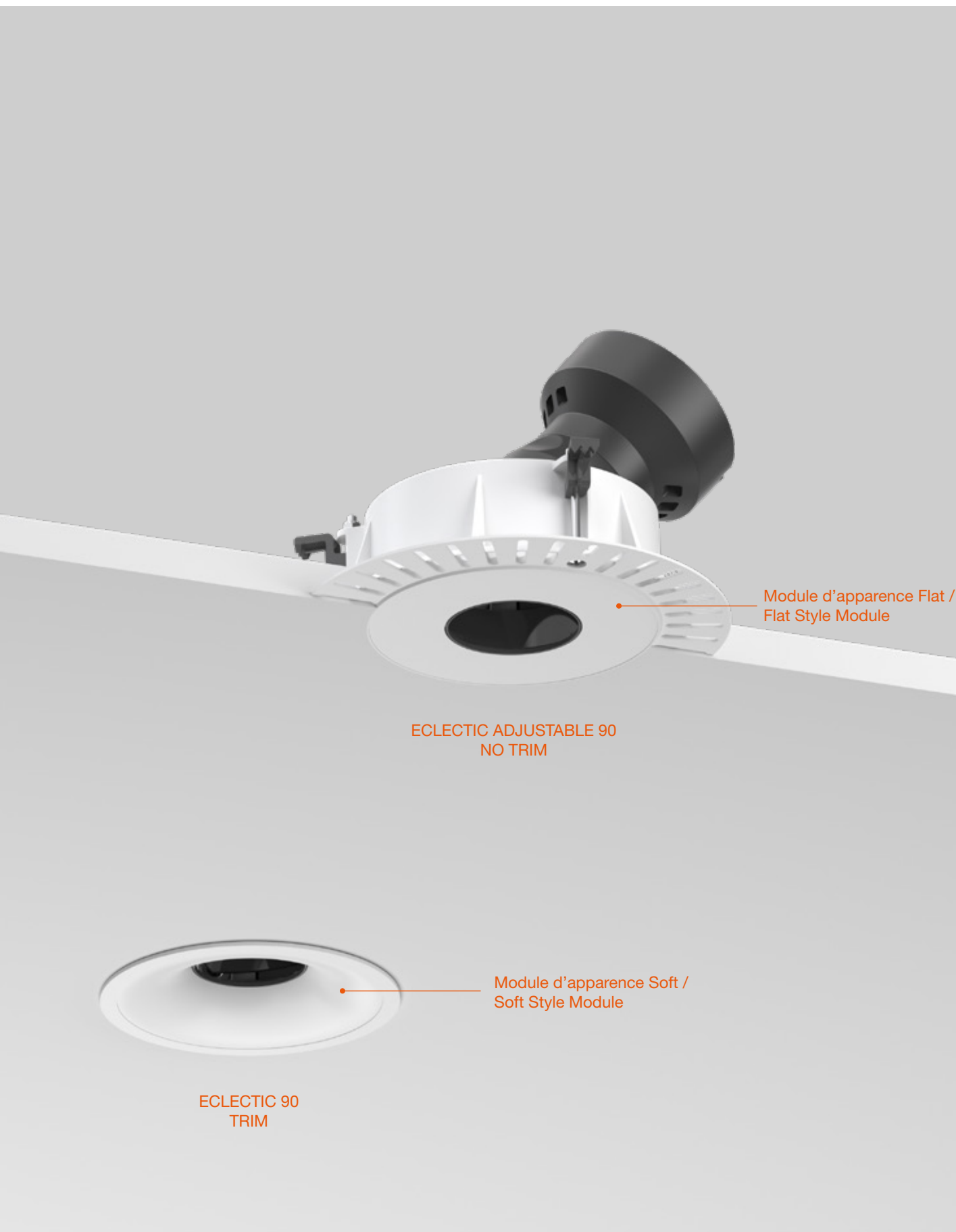







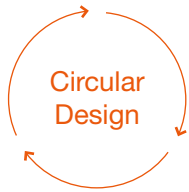

Six modules et/ou accessoires disponibles, commercialisés comme des articles indépendants. Montage et remplacement sans outils. Polyvalence maximale et possibilités de modification, même après l'installation du produit.

There are six modules and/or accessories available, marketed as individual products. Tool-free installation and replacement. Maximum versatility and modification possibilities, even after the product has been installed.



1 Précadres d'installation.
Installation pre-frames.
2 Moteur de lumière.
Light engine.

3 Lentilles.
Lenses.
4 Accessoires.
Accessories.

5. Module d'orientation
(fixe/réglable).
Orientation module
(fixed / adjustable).
6. Modules esthétiques.
Style modules.

Conception modulaire « future-proof » : à l'abri de l'obsolescence.

Modular "future-proof" design: obsolescence-proof.

1 La configuration initiale d'Eclectic ne limite pas les caractéristiques du produit grâce aux possibilités de modification et d'adaptabilité de son design. De l'esthétique à l'orientation ou à la largeur du faisceau, tout peut être modifié pour répondre aux nouveaux besoins.

1 The initial configuration of Eclectic does not limit the product in its features thanks to the modification and adaptability possibilities of its design concept. From style to orientation or beam angles, everything can be modified to meet new needs.



1 Toutes les parties du produit sont remplaçables.
1 All product parts are replaceable.

Gamme complète de largeurs de faisceau.

Complete range of beam angles.

2 Eclectic propose une gamme de largeurs, du Super Spot au Wide Flood, pour répondre à tous les besoins des prescripteurs d'éclairage.

2 Eclectic offers a variety of beam angles ranging from Super Spot to Wide Flood to meet any lighting specifier's needs.

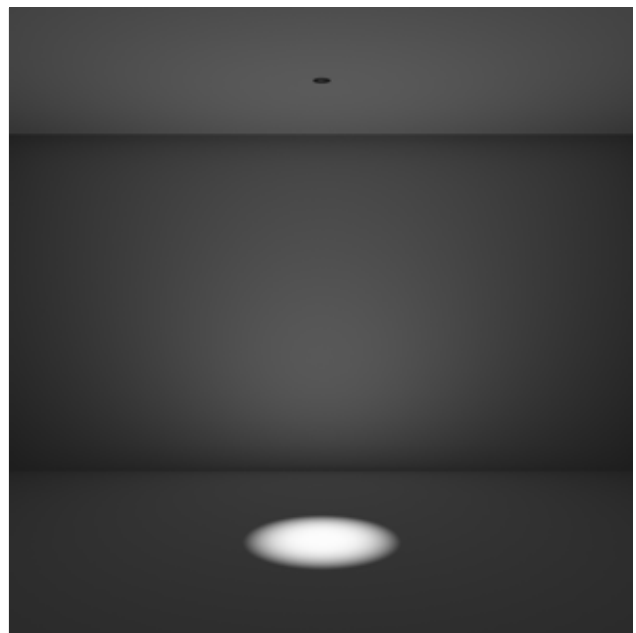

2 5 largeurs de faisceau sont disponibles.
2 Five light beam angles available.

Installation et assemblage magnétique.

Magnetic installation and assembly.

3 Eclectic s'intègre dans les précadres d'installation par un système de fixation magnétique de haute qualité testé et soumis aux essais de résistance, de charge et de durabilité les plus rigoureux. Cette fixation magnétique est également le mode de fixation des façades et favorise la manipulation du produit pour le modifier, remplacer et mettre à jour.

3 Eclectic attaches to its installation pre-frames thanks to a high quality magnetic attachment system that has been tested and subjected to the most demanding stress, load and durability tests. This magnetic fixing, which is also the way the style façades are attached, facilitates the handling of the product for modification, replacement and upgrading.

Un seul produit, trois apparences différentes.

One product, three different styles.

4 Modifier l'apparence d'Eclectic est si simple : changez le module d'apparence par un autre, au choix entre trois modèles (Cone, Soft et Flat). De plus, dans les versions No Trim, il est possible de modifier la finition du luminaire (du noir au blanc et vice-versa), uniquement en remplaçant cette pièce par le module de rechange d'une autre couleur.

4 Renewing the appearance of Eclectic is as easy as replacing its style module with a new one, choosing among its three alternatives (Cone, Soft and Flat). In addition, in the No Trim versions, we can even change the finish of the luminaire (from black to white or vice versa), by simply replacing this part with its spare module in a different color.



3 Fixé magnétiquement pour une installation et des modifications faciles.
3 Magnetically attached for easy changeover and installation.

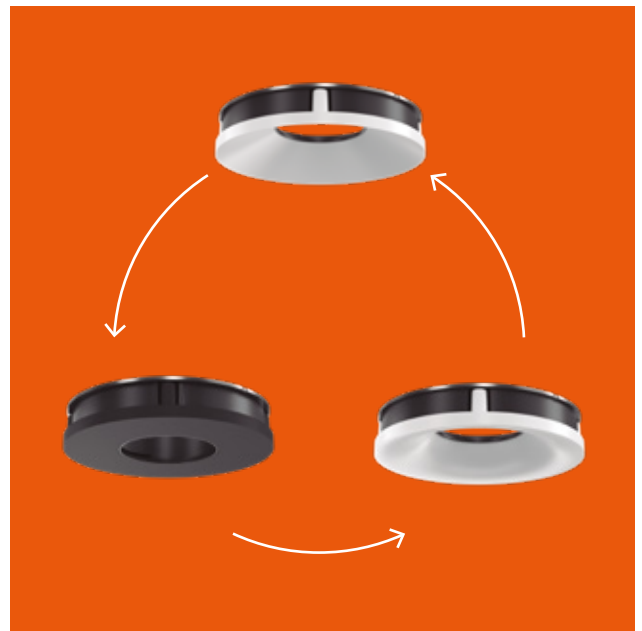

4 Esthétique interchangeable. Cone, Soft & Flat.
4 Interchangeable style. Cone, Soft & Flat.

Grâce à la solution optique exclusive et brevetée, le Eclectic contrôle des angles cut-off extrêmes sans compromettre la haute efficacité et l'incroyable polyvalence du produit.

Thanks to the unique patented optical solution, Eclectic controls extreme cut-off angles without altering the high efficiency and incredible versatility of the product.

UGR<10

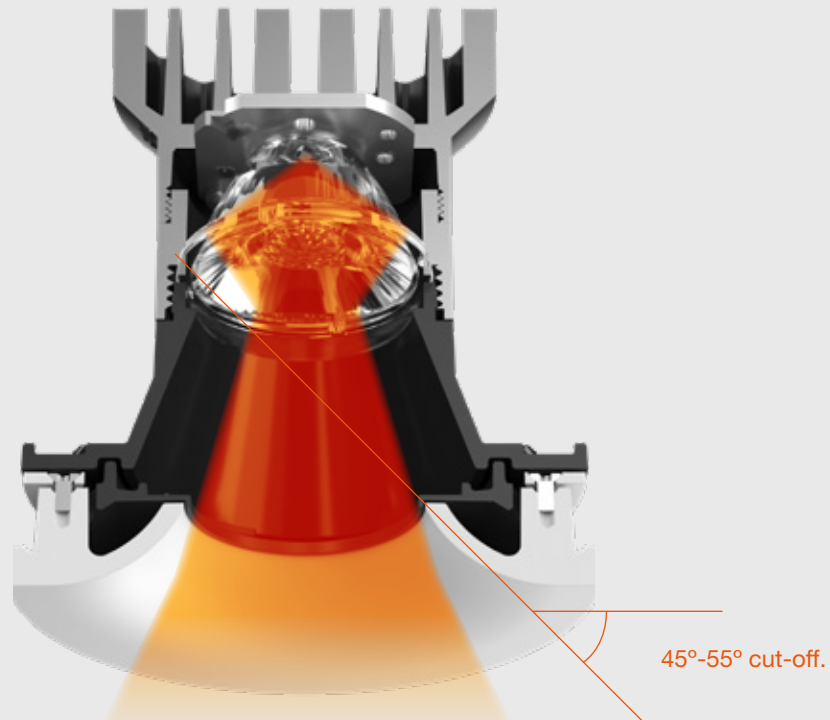

Lentille à double foyer développée par FLOS spécifiquement pour ce produit. Elle assure un contrôle optique maximal et une homogénéité exceptionnelle du faisceau lumineux.

Dual-focus lens developed by FLOS specifically for this product. It ensures maximum optical control and exceptional light beam homogeneity.

INTENSITÉ ET TEMPÉRATURE DE LA LUMIÈRE, SYNCHRONISÉES EN DOUCEUR

Eclectic dispose d'une option de variation Dim to Warm, qui lie l'intensité au changement de couleur de la lumière. Ainsi, plus le flux lumineux est élevé, plus la lumière est froide et plus le flux est faible, plus la lumière est chaude. Polyvalence pour un éclairage doux et agréable.

LIGHT INTENSITY AND TEMPERATURE, SWEETLY SYNCHRONISED

Eclectic has a Dim to Warm dimming option, which links the intensity to the change in the colour of the light. Thus, the higher the flux, the cooler the light and the lower the light, the warmer. Versatility for soft and pleasant lighting.

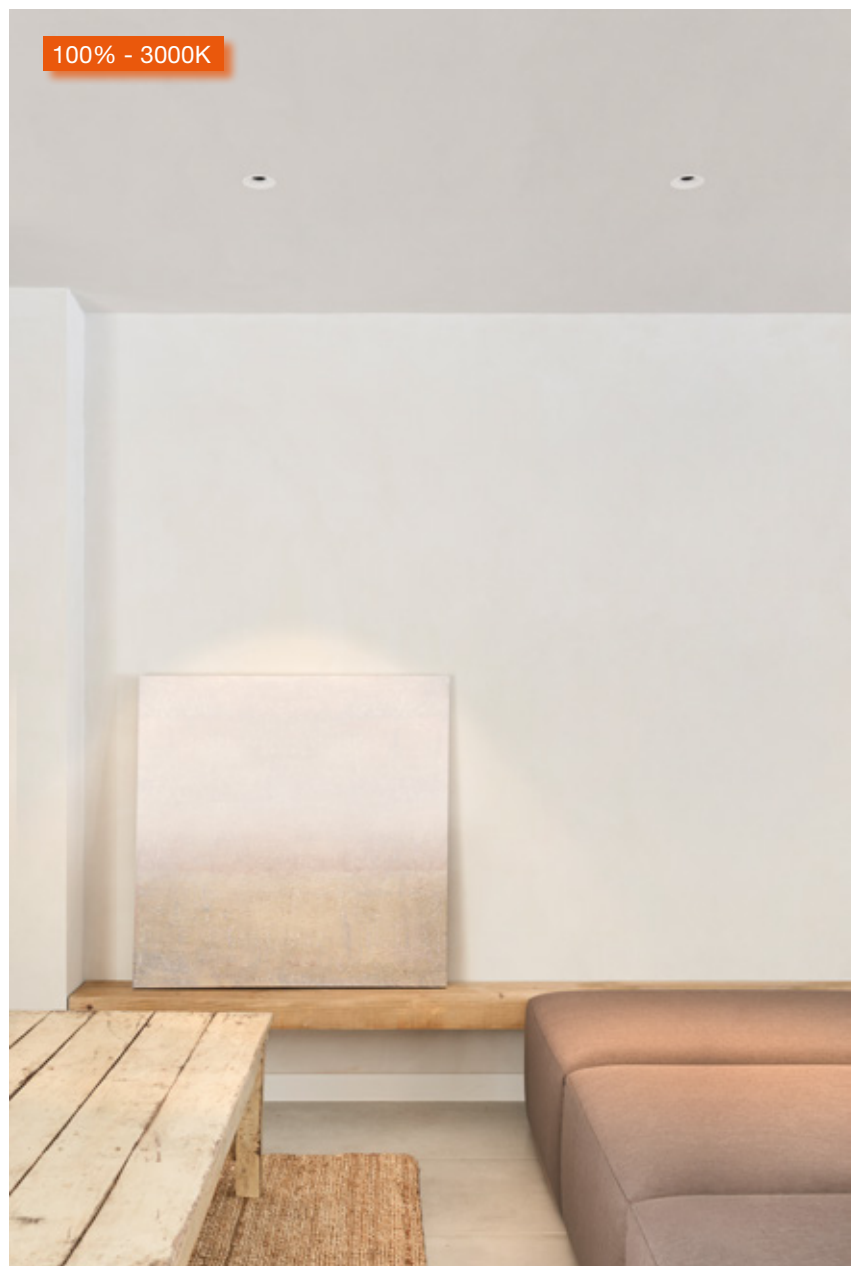
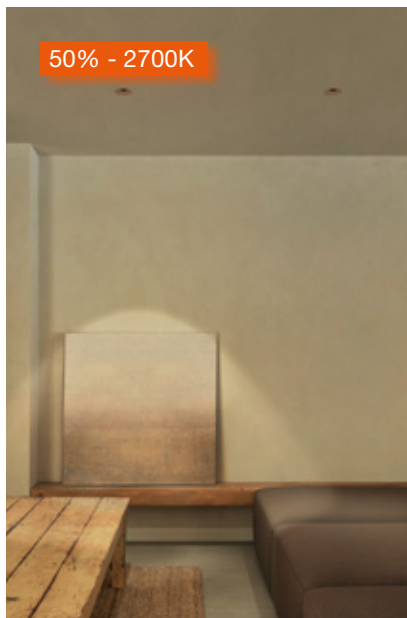
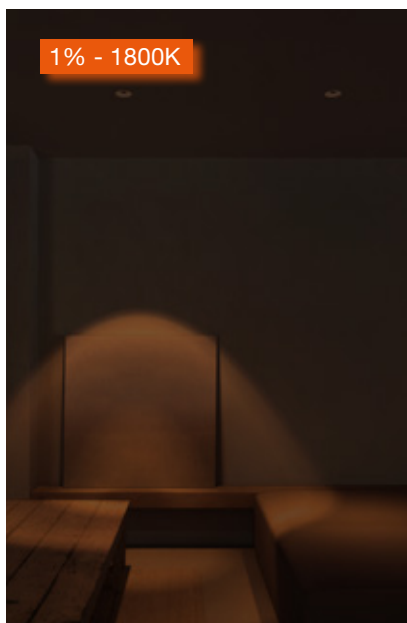

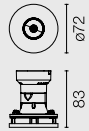
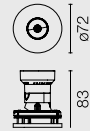
FIXED 70
TRIM / NO TRIMADJUSTABLE 70
TRIM / NO TRIM

LED ARRAY
7,5W

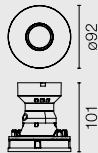
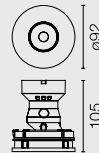
FIXED 90
TRIM / NO TRIMADJUSTABLE 90
TRIM / NO TRIM

LED ARRAY
10,5W

POWER LED
7W

LED ARRAY
DIM TO WARM
13W

Ces photos montrent Eclectic équipé d'un module d'apparence Cone, mais vous pouvez consulter les options suivantes pour choisir l'apparence qui s'adapte le mieux à votre projet.

The product pictures above represent Eclectic equipped with a Cone Style module, but you can refer to the options below to select the style you prefer to match your project.

Cone



□ Blanc
White

■ Noir
Black

Flat



□ Blanc
White

■ Noir
Black

Soft



□ Blanc
White

■ Noir
Black

Peut être tourné à 360° et pivoté à 35° pour la version Ø70 et à 40° pour la version Ø90.
Can be rotated 360° and swivelled 35° for Ø70 version and 40° for Ø90 version.

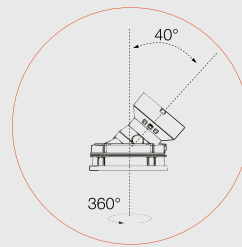
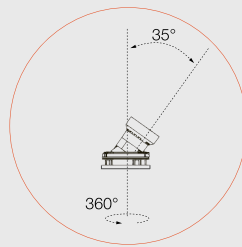

Super Spot



Spot



Medium



Flood



Wide Flood

FLOS

CONTROL BY CASAMBI



LIGHT SHADOW

S P O T

LIGHT SHADOW

S P O T

LIGHT SHADOW

S P O T

LIGHT SHADOW

S P O T

LIGHT SHADOW

S P O T

Le système optique de Light Shadow, avec sa lentille à double foyer, est étendu à cette famille de projecteurs pour offrir sa technologie, exclusive et brevetée par Flos, dans cette application d'éclairage. Une collection de projecteurs en trois tailles qui sont mis en œuvre dans différents systèmes, des rails triphasés standard aux structures propres à Flos (The Tracking Magnet, The Running Magnet et Infra-Structure).

Light Shadow's optical system -with its dual-focus lens- is extended to this family of projectors to offer its exclusive and patented by Flos technology in this lighting fixture. A collection of spotlights in three sizes that are implemented in different systems, from standard three-phase tracks to Flos' own structures (The Tracking Magnet, The Running Magnet and Infra-Structure).

LIGHT SHADOW SPOT







Grâce à la solution optique exclusive et brevetée, le Light Shadow Pro contrôle des angles cut-off extrêmes sans compromettre la haute efficacité et l'incroyable polyvalence du produit.

Thanks to the unique patented optical solution, Light Shadow Pro controls extreme cut-off angles without altering the high efficiency and incredible versatility of the product.

1 Lentille à double foyer développée par FLOS spécifiquement pour ce produit. Elle assure un contrôle optique maximal et une homogénéité exceptionnelle du faisceau lumineux.

Dual-focus lens developed by FLOS specifically for this product. It ensures maximum optical control and exceptional light beam homogeneity.

2 Light Shadow Spots est équipé d'un accessoire anti-éblouissement honeycomb qui combine la technologie de confort visuel élevé du Light Shadow avec cet abat-jour pour restreindre davantage l'accès visuel à la source lumineuse.

Light Shadow spots have an anti-glare honeycomb accessory to combine the high visual comfort technology of Light Shadow with this screen to further restrict visual access to the light source.

LIGHT SHADOW SPOT Ø45

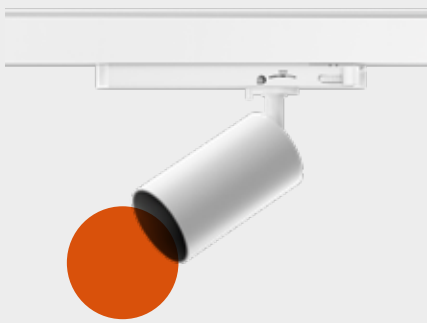

1

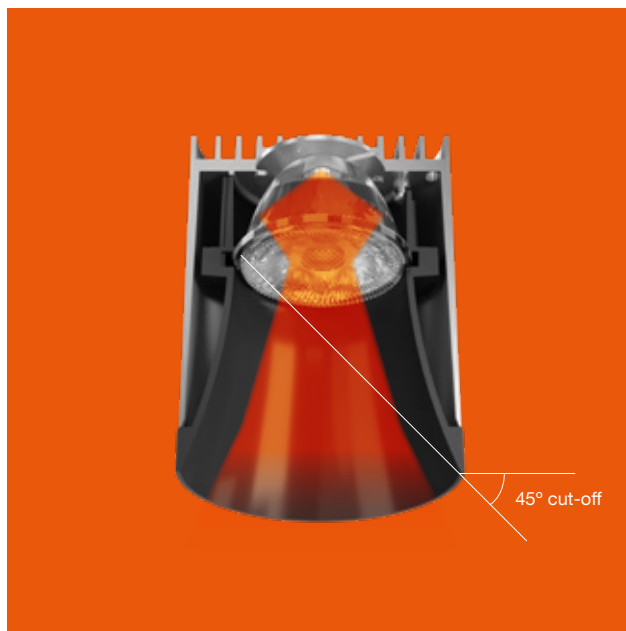

1

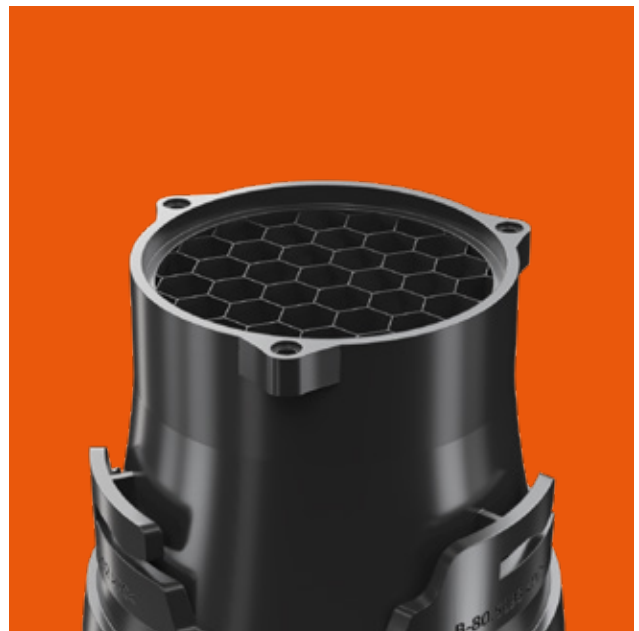

2

3 Les filtres dichroïques CCT permettent de faire varier la température de couleur des projecteurs Light Shadow vers des options plus froides ou plus chaudes afin d'obtenir le ton de lumière souhaité.

To obtain the desired light tone, CCT dichroic filters allow the color temperature of the Light Shadow projectors to be varied for cooler or warmer options.

4 Sur demande, Flos propose des finitions spéciales aussi bien pour le corps des luminaires que pour la partie arrière et le bras arrière du produit.

Available on request, Flos offers special finishes for both the body of the luminaires and for the back and rear arm of the product.

LIGHT SHADOW SPOT Ø60

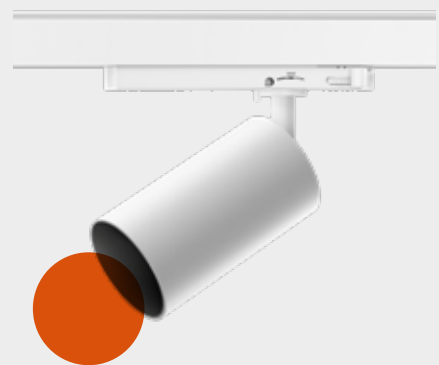

1



3



4

- 1 SUPER SPOT
- 2 SPOT
- 3 MEDIUM
- 4 FLOOD
- 5 WIDE FLOOD

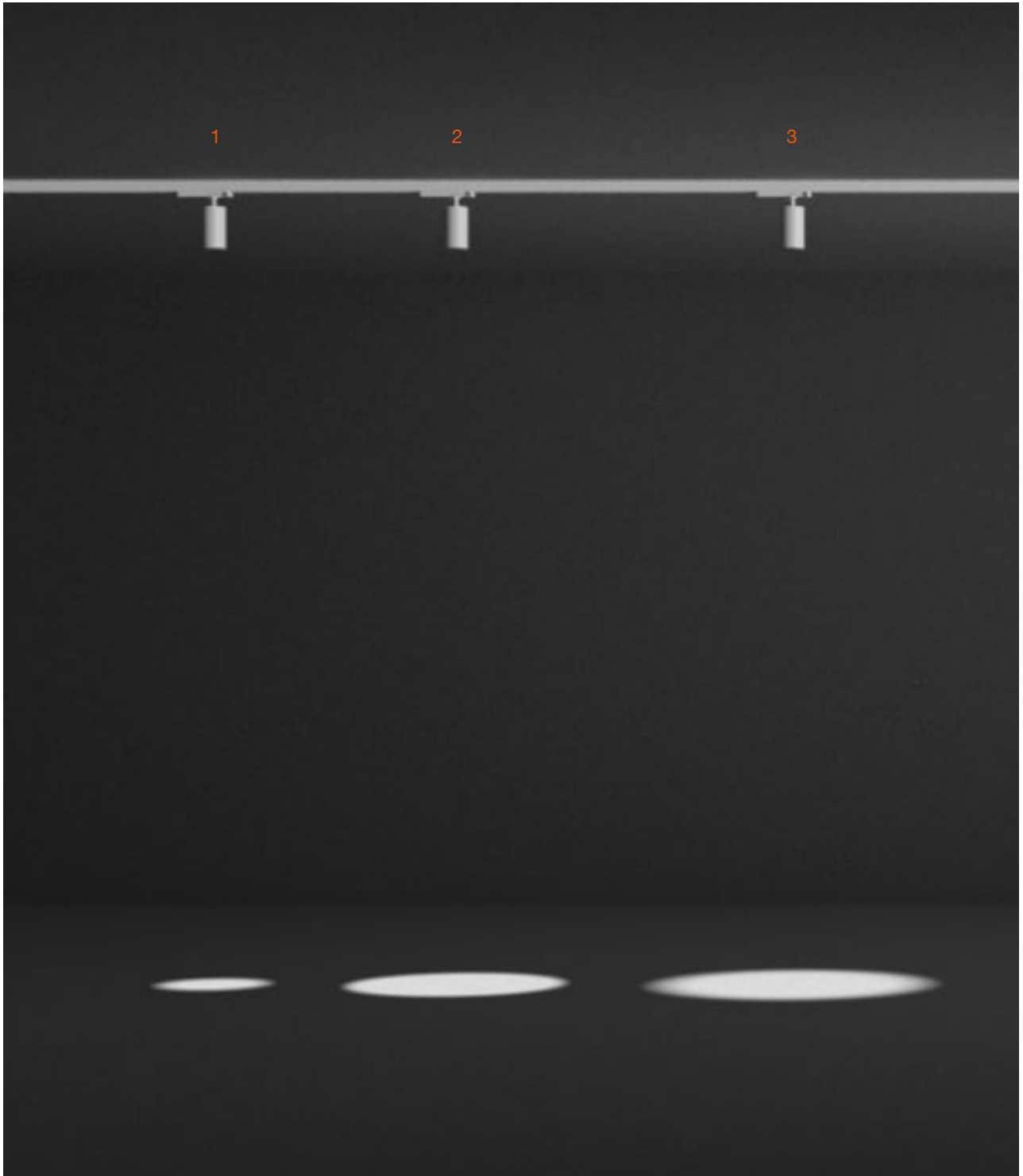

BEAM ANGLES

La collection de projecteurs Light Shadow Spots offre une gamme d'optiques qui donne au concepteur toutes les options professionnelles nécessaires pour n'importe quel projet. Des largeurs Super Spot aux largeurs Wide Flood, un seul produit propose toutes les solutions.

BEAM ANGLES

The Light Shadow Spots collection offers a range of optics that provide the specifier with all the professional options needed for any project. From Super Spot to Wide Flood apertures, one product with all the solutions.

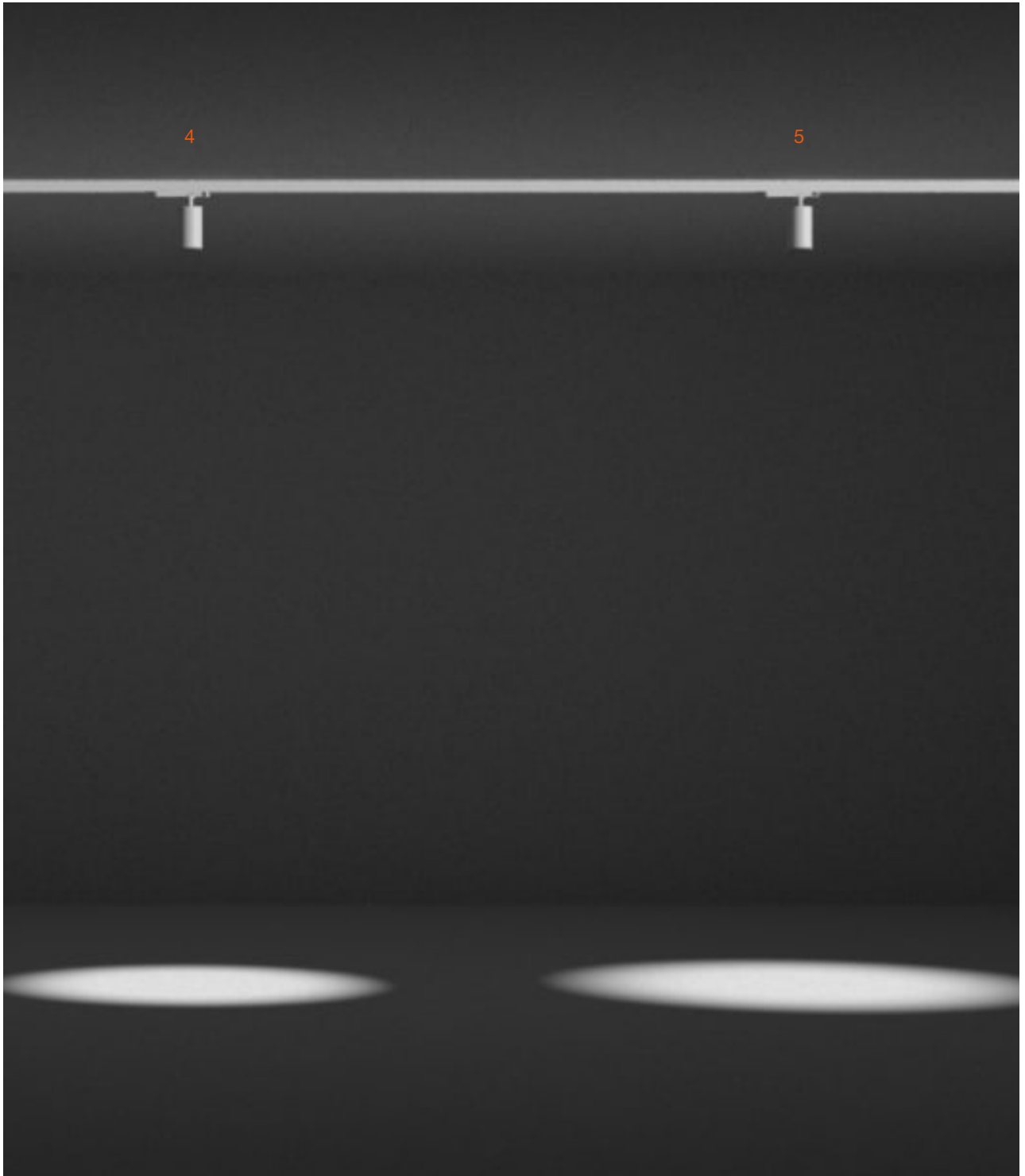







Différentes options de contrôle peuvent être adaptées à n'importe quel besoin.

Different control options that can be adapted to any need.

DALI

Contrôle à distance de type « broadcast » (variation de tous les luminaires d'un même groupe).

Standard protocol for integration with any control system.

CASAMBI

Contrôle individuel de chaque luminaire ou contrôle à distance de type « broadcast » directement depuis une application pour tablette ou smartphone (FLOS Control®).

Individual control of each luminaire or broadcast remote control directly through a tablet or smartphone application (FLOS Control®).

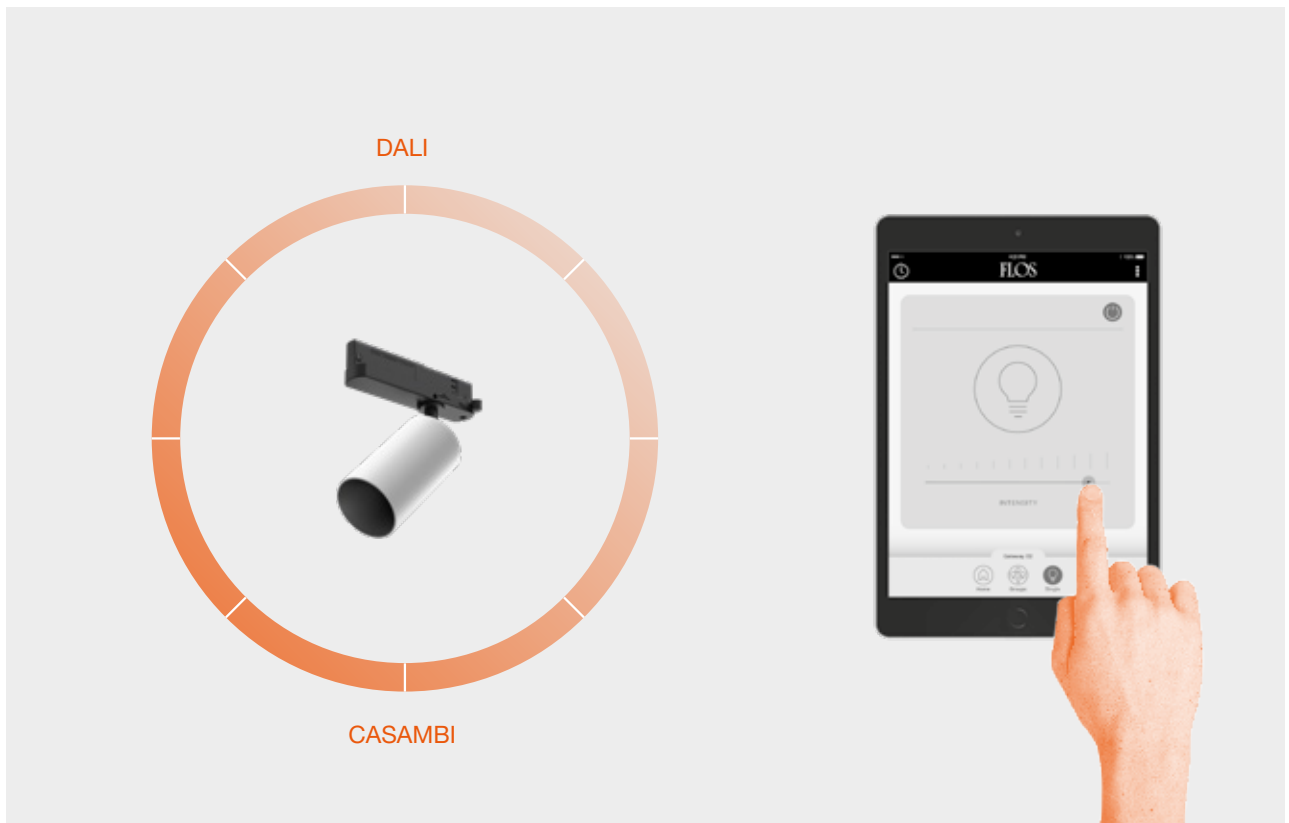

FLOS CONTROL®
BY CASAMBI

L'application FLOS Control® permet de contrôler les appareils d'éclairage du système individuellement ou par groupe, en contrôlant les scènes et la programmation.

The FLOS Control® application allows you to control the system's luminaires individually or as a group, controlling scenes and programming.

Il suffit d'une installation électrique traditionnelle et du Gateway connecté par Bluetooth pour obtenir un contrôle total de l'espace.

With a traditional electrical installation and the Gateway connected by Bluetooth, you obtain total control of the ambience.

Disponible pour IOS et Android

Available for iOS and Android

LIGHT SHADOW SPOT 45



LED ARRAY
11,5W

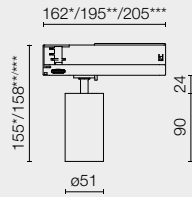

LIGHT SHADOW SPOT 60



LED ARRAY
Up to 22W

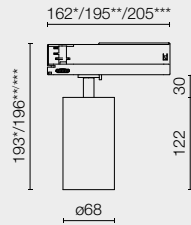

Non Dimming* / Casambi** / Dali***

Compatible avec The Tracking Magnet & Infra-Structure.
Compatible with The Tracking Magnet & Infra-Structure.

LIGHT SHADOW
SPOT 30



LIGHT SHADOW
SPOT 45



LIGHT SHADOW
SPOT 60



Compatible avec The Running Magnet.
Compatible with The Running Magnet.

LIGHT SHADOW
SPOT 30



LIGHT SHADOW
SPOT 45



☐ 40 Blanc
40 White



■ 14 Noir
14 Black



☑ 40.78/YU/C6 All White



■ EQ Cuivre Brossé
EQ Brushed Copper



▨ ER Acier Brossé
ER Brushed Steel



■ ES Bronze Brossé
ES Brushed Bronze



Super Spot



Spot



Medium



Flood



Wide Flood

FLOS
CONTROL BY CASAMBI



CCCCCC

AAAAAA

MMMMMM

EEEEEE

RRRRRR

AAAAAA

CAMERA

Programme novateur de projecteurs sur rail, conçu pour des applications dans des musées et des boutiques. Le système optique exclusif et breveté a été appliqué à de multiples largeurs de faisceaux spécialement conçues avec un contrôle maximal de l'éblouissement.

Innovative program of track mounted projectors, designed for museum and retail applications. The unique patented optical system has been applied to multiple purpose-built beamwidths with maximum glare control.

CAMERA

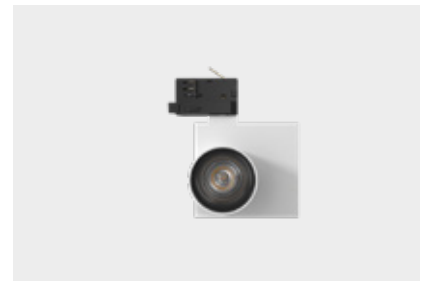
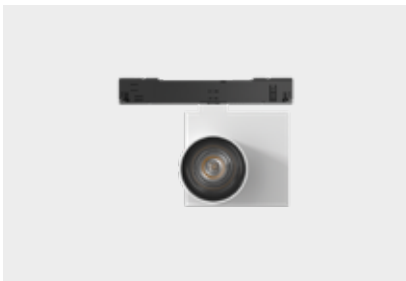



Pilotage Building,
AntwerpPhoto Festival, Belgium



Un design sobre et compact pour un produit extrêmement professionnel. Volume neutre mais facilement reconnaissable.

Subtle and compact design for an extremely professional product. Neutral but easily recognizable volume.





CAMERA Ø90



La lentille en silicone à double foyer développée par FLOS a une excellente résistance à la chaleur et permet d'obtenir des faisceaux précis de haute intensité.

The dual-focus silicone lens developed by FLOS features excellent heat resistance and allows precise high-intensity beams.



Régulateur de puissance intégré dans le corps du produit, disponible en option pour contrôler le projecteur individuellement.

Power regulator integrated in the product body, available as an option to control the projector individually.





Pilotage Building,
AntwerpPhoto Festival, Belgium



Des caractéristiques techniques hautement professionnelles et des détails de conception de qualité intégrés dans un design unique.

Highly professional technical features and quality construction details integrated into a unique design.

1 Camera peut être orienté à 90° sur l'axe horizontal pour un éclairage zénithal.
Camera can be oriented at 90° on the horizontal axis for zenithal lighting.

2 L'adaptateur spécial amovible pour rail s'intègre dans le produit jusqu'à sa disparition.
The special, removable rail adapter is integrated into the product until it disappears.

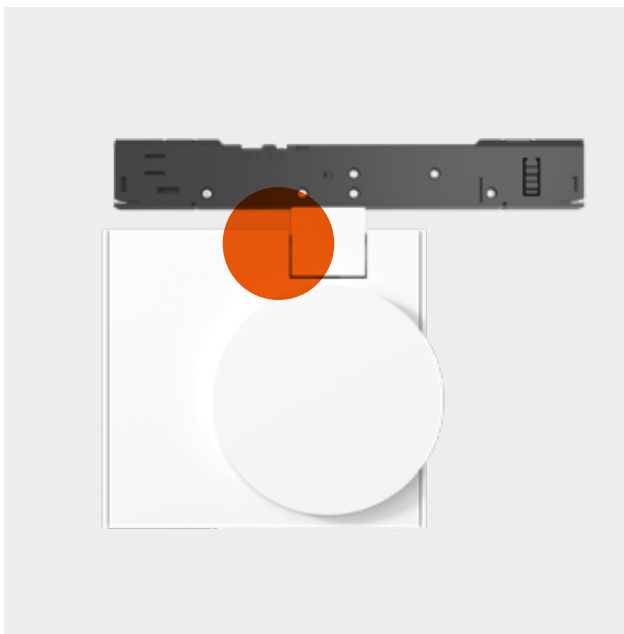

1



2

Solution optique exclusive et brevetée.

Exclusive patented optical solution.

4 Kit d'accessoires dédié, disponible pour toutes les versions du programme.
Dedicated accessory kit available for all versions of the program.

3 Camera contrôle des angles cut-off extrêmes sans compromettre ni le haut rendement élevé (97%) ni la polyvalence inégalés du produit.
Camera controls extreme cut-off angles while maintaining its high efficiency (97%) and unparalleled product versatility.

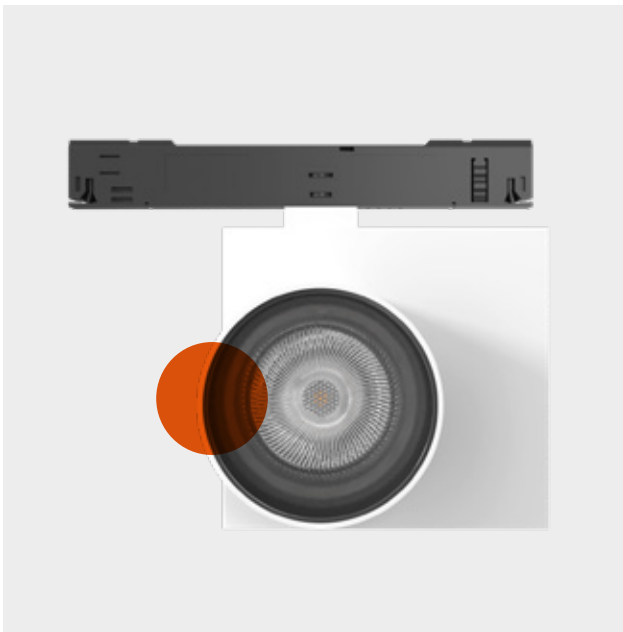

Le kit optique disponible comprend 5 largeurs de faisceau différentes, chacune étant développée pour une application spécifique. Qu'il s'agisse de faisceaux intenses ou d'effets de lumière diffuse, le contrôle optique est toujours exceptionnel et la lumière parasite est totalement absente.

The optical kit available includes 5 different beamwidths. Each one of them is developed for a specific application. The optical control is always exceptional and the stray light is totally absent whether for intensive beams or diffuse lighting effects.

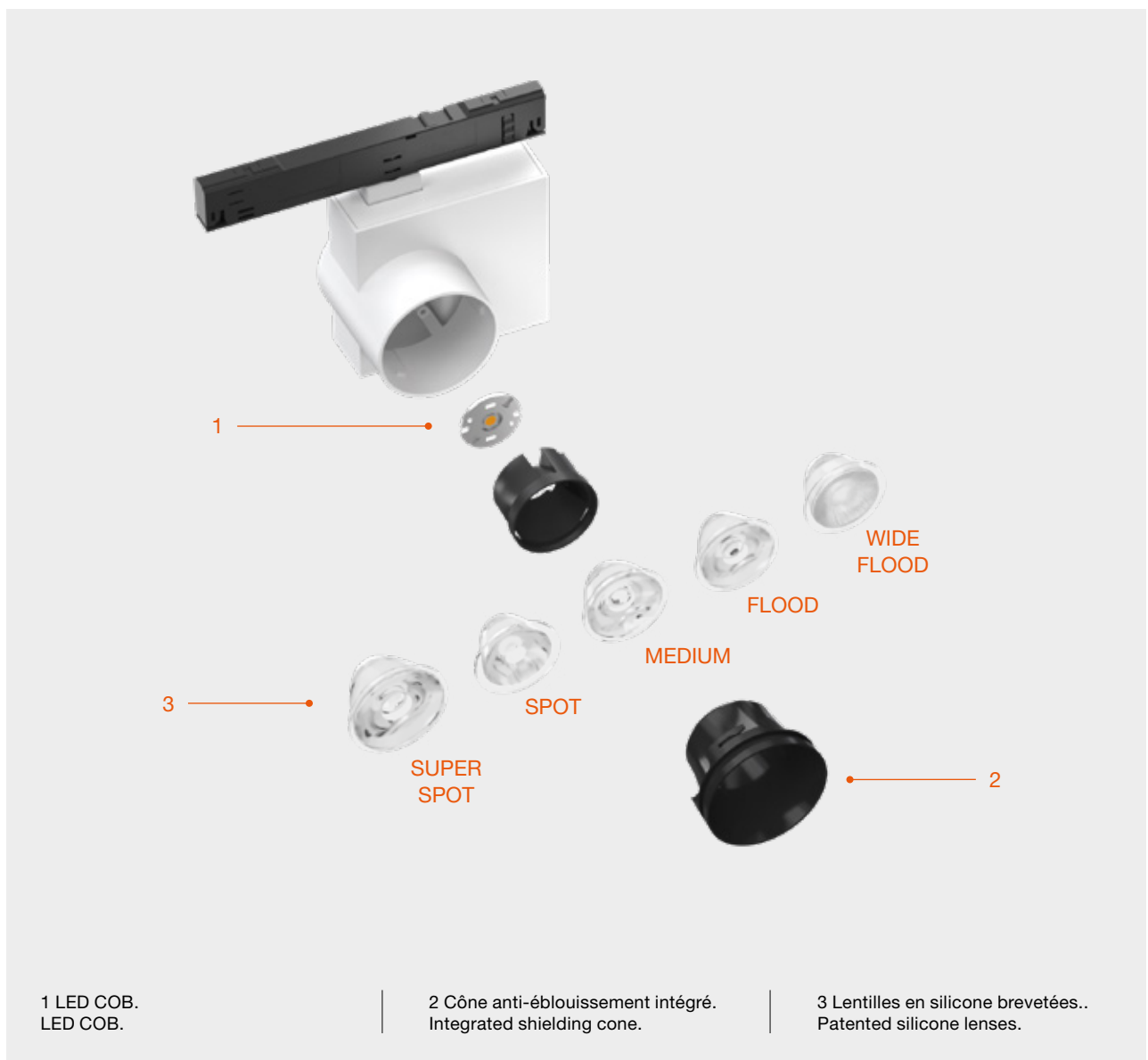

Le groupe optique full cut-off
garantit un contrôle visuel maximal
et génère une homogénéité inégalée
dans le faisceau lumineux.

The full cut-off optical unit guaran-
tees maximum visual control and
generates an unparalleled homoge-
neity in the light beam.

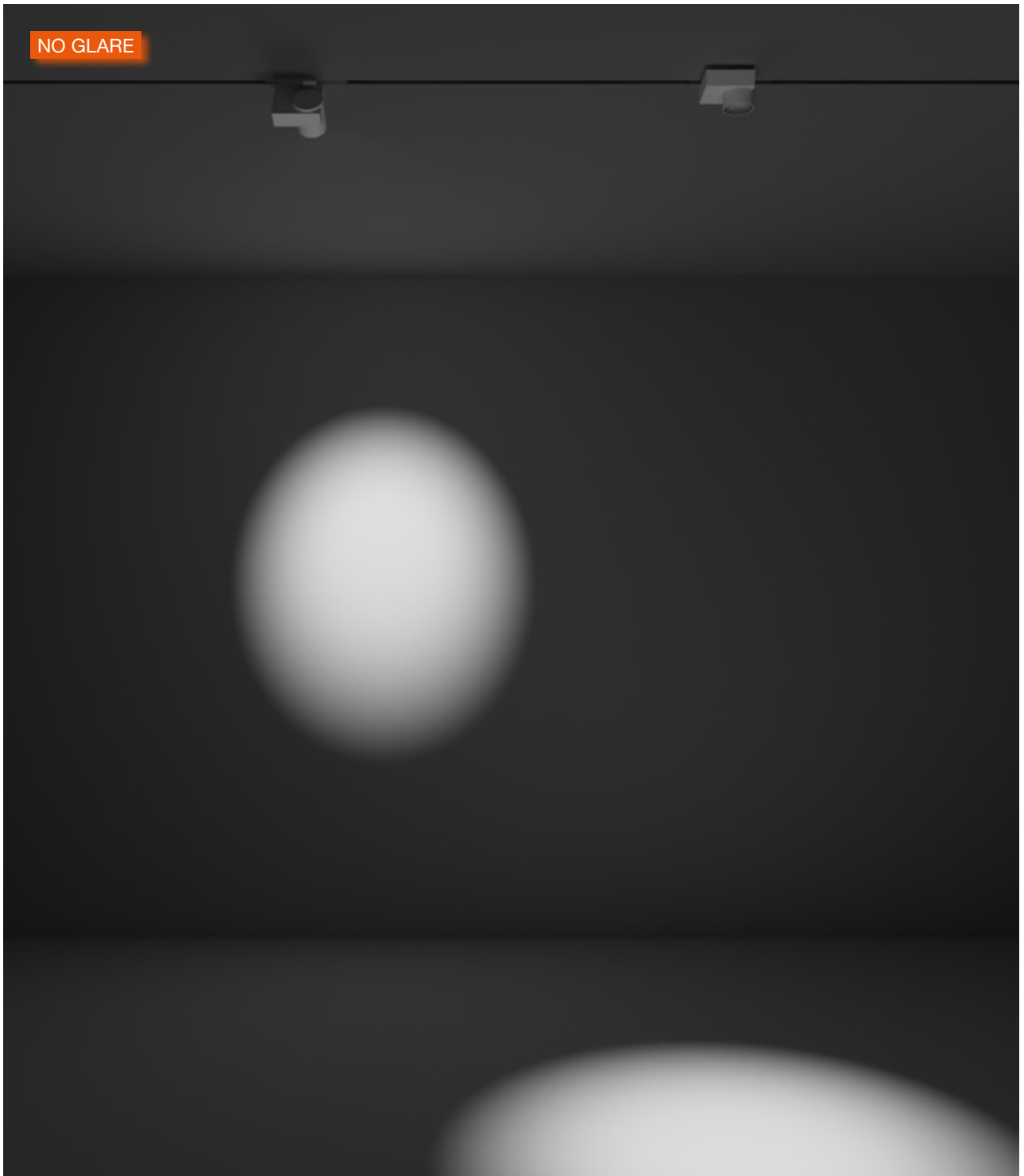



CAMERA Ø60



LED ARRAY
UP to 20W

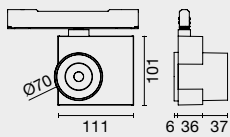

CAMERA Ø90

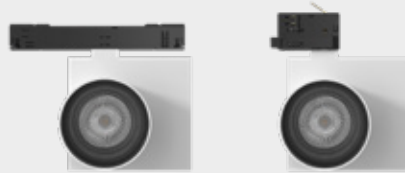

LED ARRAY
UP to 32W

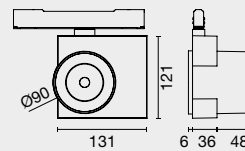

Compatible avec The Tracking Power.
Compatible with The Tracking Power.

□ 40 Blanc
40 White

■ 14 Noir
14 Black



Super Spot



Spot



Medium



Flood



Wide Flood

FLOS
CONTROL BY CASAMBI



SUPER

& PRO LINE & PRO

LINE & PRO LINE

SUPER

& PRO LINE & PRO

LINE & PRO LINE

SUPER

Luminaire de haut niveau technologique, efficace et délicat, constitué d'une barre combinant la lumière directe et indirecte, maintenue par deux câbles coaxiaux qui fournissent le support et le câblage électrique. Parfait pour des bureaux ou des lieux nécessitant un éclairage très efficace et confortable.

Efficient and delicate luminaire featuring a high technological level. It is composed of a bar combining direct and indirect light and held by two coaxial cables that provide support and electrical wiring. Perfect for offices or places that require high lighting efficiency and comfort.

SUPER LINE & PRO







Super Line est équipé d'un filtre diffuseur technique multicouches qui garantit une distribution parfaite de la lumière et améliore l'effet optique et le confort visuel. Super Line Pro contient une grille noire qui permet un contrôle total de la distribution lumineuse et un confort maximum dans les zones de travail.

Super Line is equipped with a technical multi-layer diffuser filter that guarantees perfect light distribution and improves the optical effect and visual comfort. Super Line Pro is fitted with a black raster that ensures total control of the light distribution and maximum comfort in work environments.

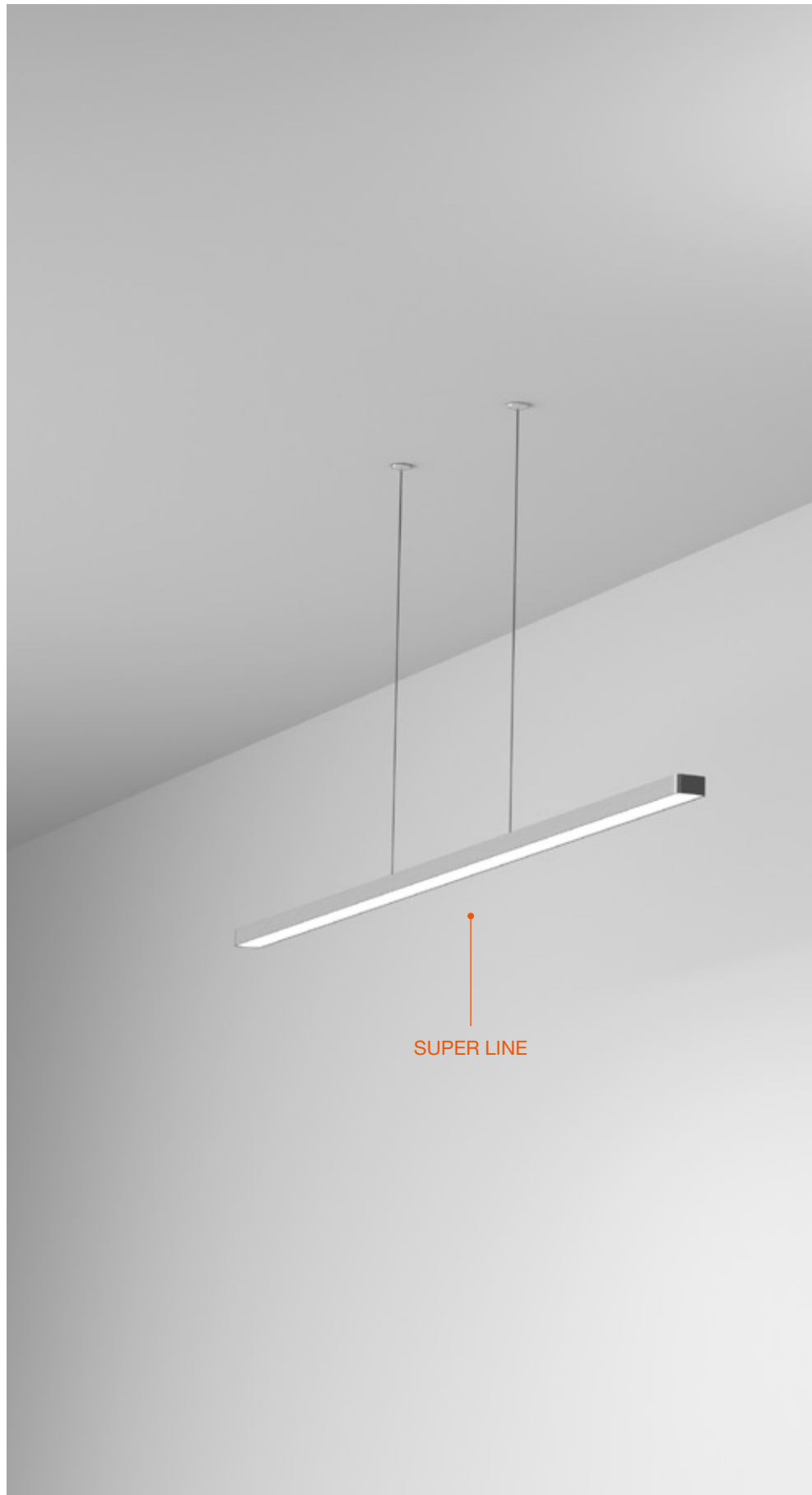

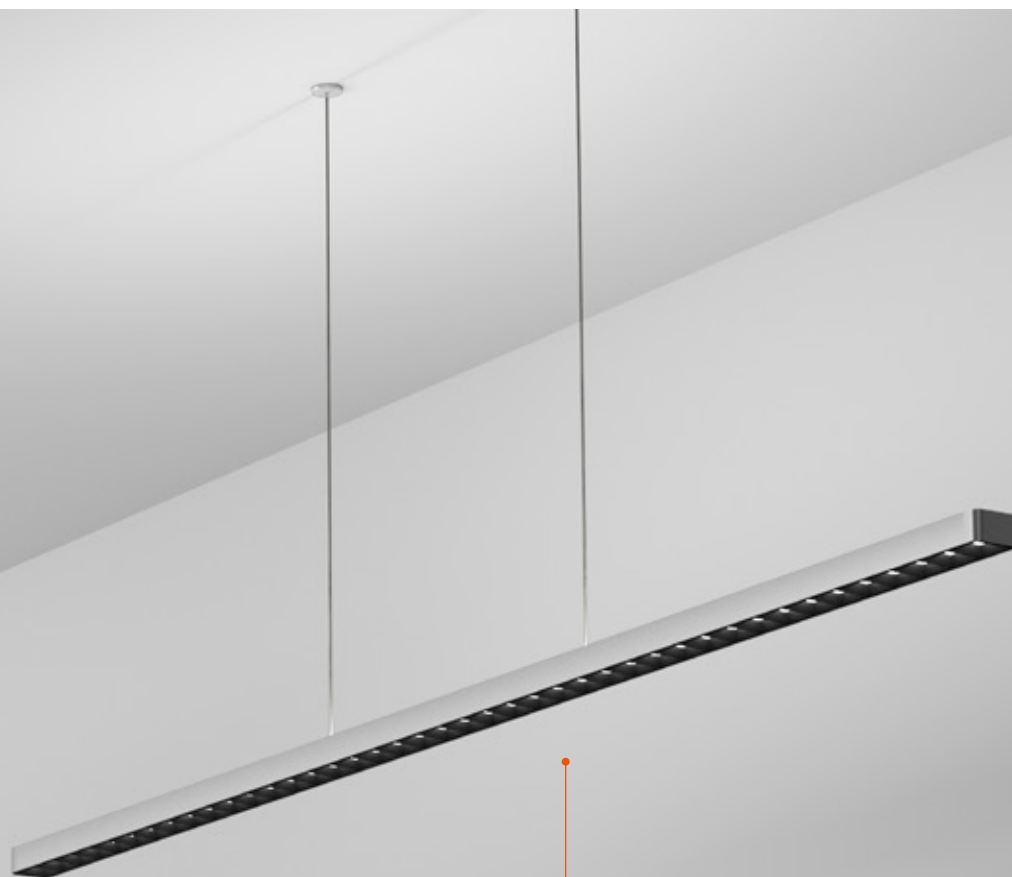

SUPER LINE PRO



Le groupe optique qui caractérise le Super Line Pro est breveté et consiste en une trame optique modulaire à cellules quadrangulaires combinée à une lentille primaire.

The patented optical unit that characterizes Super Line Pro consists of a modular optical raster with four-sided cells combined with a primary lens.



Alimentée par câble coaxial.

Powered by a coaxial cable.

1 L'installation au plafond est réalisée au moyen d'un système breveté d'encastrement à réglage rapide qui permet d'ajuster la longueur des câbles lors de l'installation.

The ceiling installation is carried out by means of a patented recessing system for quick adjustment that allows you to adjust the cables length during the installation.

2 La sortie des câbles de l'appareil est individuelle, ce qui permet le contrôle des émissions directes et indirectes. Elle est marquée par un élément spécifique portant les mots "Up Light" et "Down Light".

The device's cable outlet is individual for direct and indirect emission control, and is marked by a specific printed element showing the words "Up Light" and "Down Light".

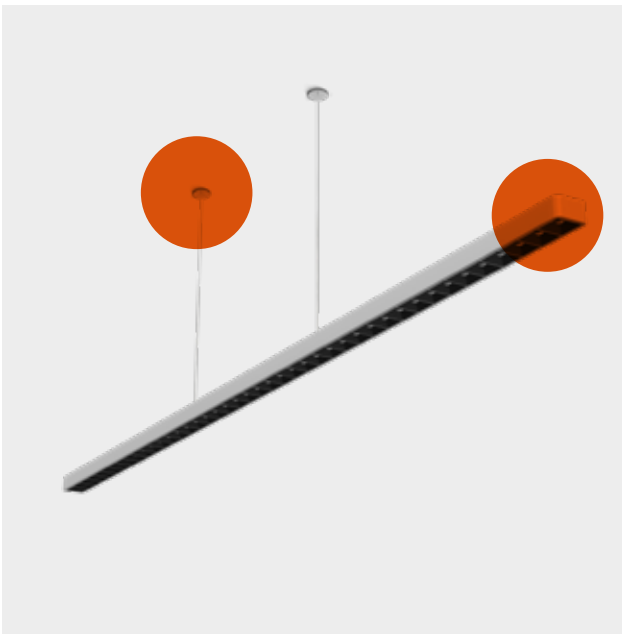

1



2



Solution optique exclusive et brevetée.

Exclusive patented optical solution.

3 La lentille principale est en PMMA avec une texturation de surface spécifique et une finition Frosted qui assurent l'homogénéité maximale de l'effet lumineux. The main lens is made of PMMA. It features a dedicated surface texturing and Frosted finish to guarantee the maximum homogeneity of the lighting effect.

4 Le profilé supérieur du luminaire a été développé en combinaison avec la lentille pour empêcher la lumière indirecte de le frapper, ce qui provoquerait un éblouissement dérangeant pour l'œil.

The upper profile of the luminaire has been developed in combination with the lens to prevent indirect light from hitting it, which would cause an unpleasant glare to the eye.

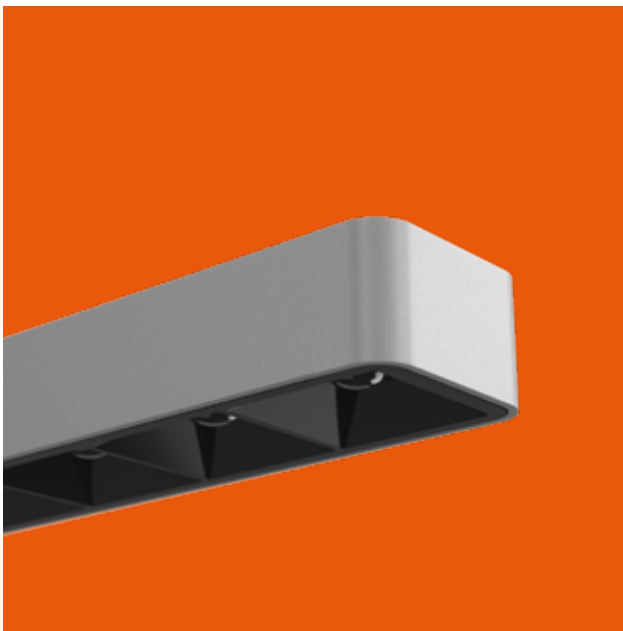
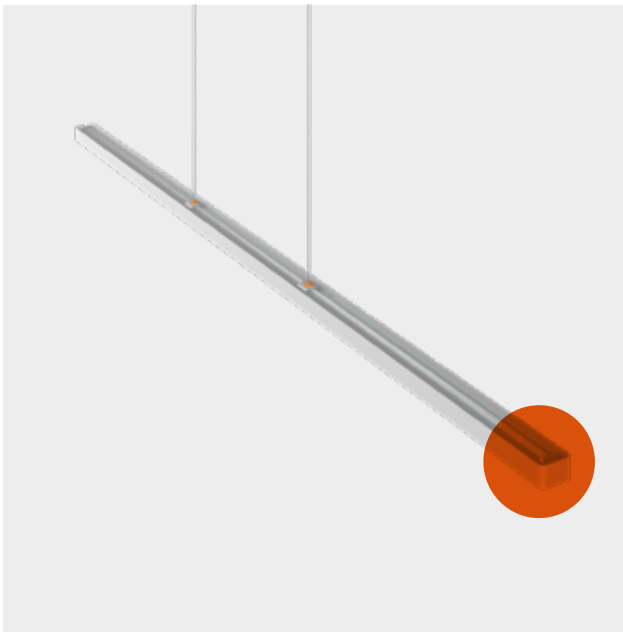

3

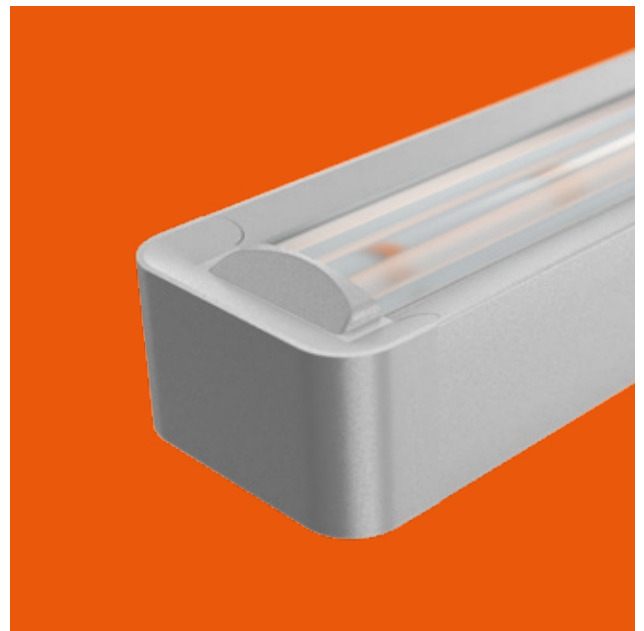

4

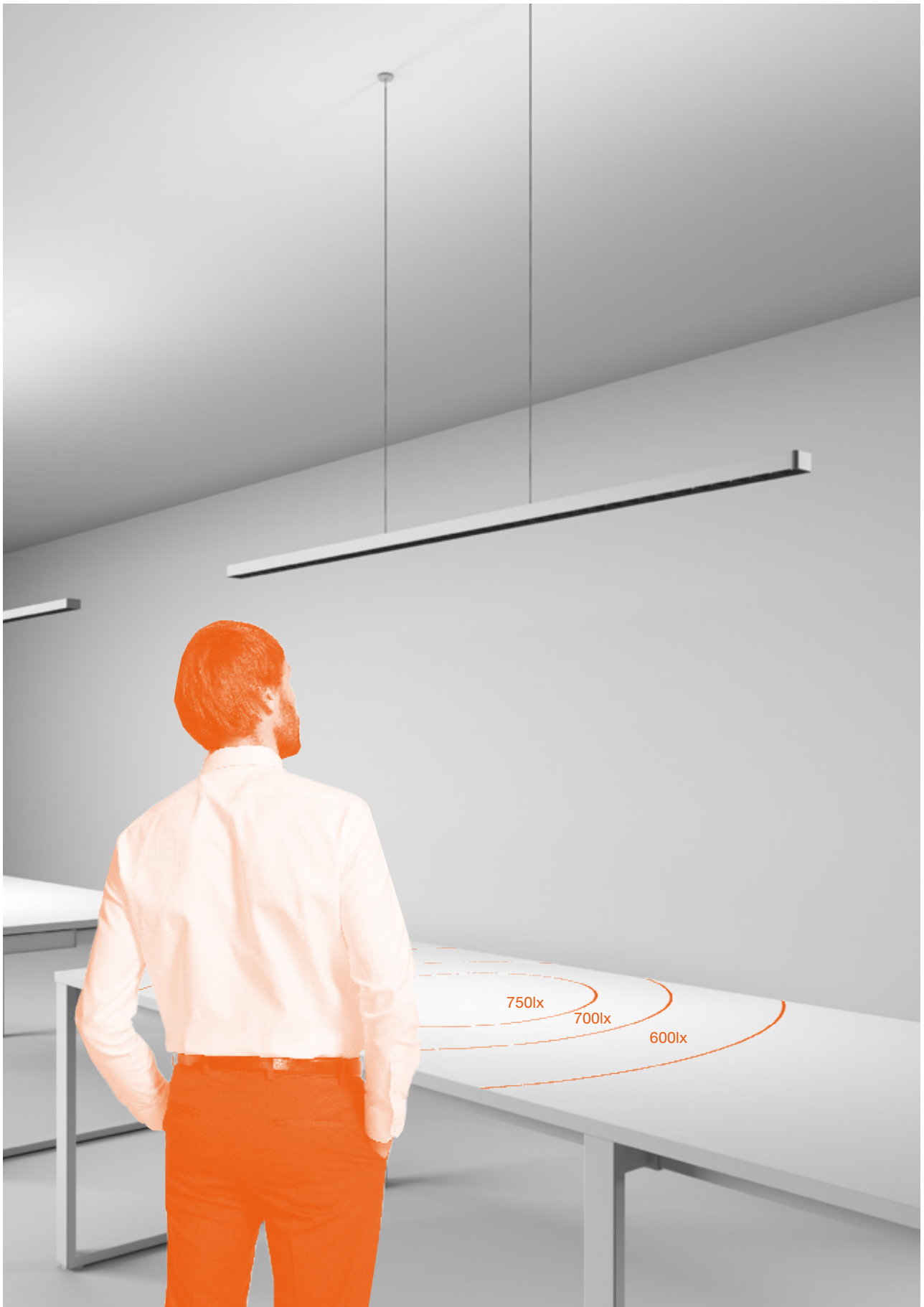

La source lumineuse utilisée pour gérer l'émission directe est placée très en arrière à l'intérieur du profilé, permettant ainsi de profiter du contrôle maximal de l'éblouissement direct. Le groupe optique breveté a été développé spécifiquement pour des applications dans des ambiances Office.

The light source used for managing the direct emission is positioned far back inside the profile in order to seize the maximum control of the direct glare. The patented optical unit was specifically developed for applications in Office environments.

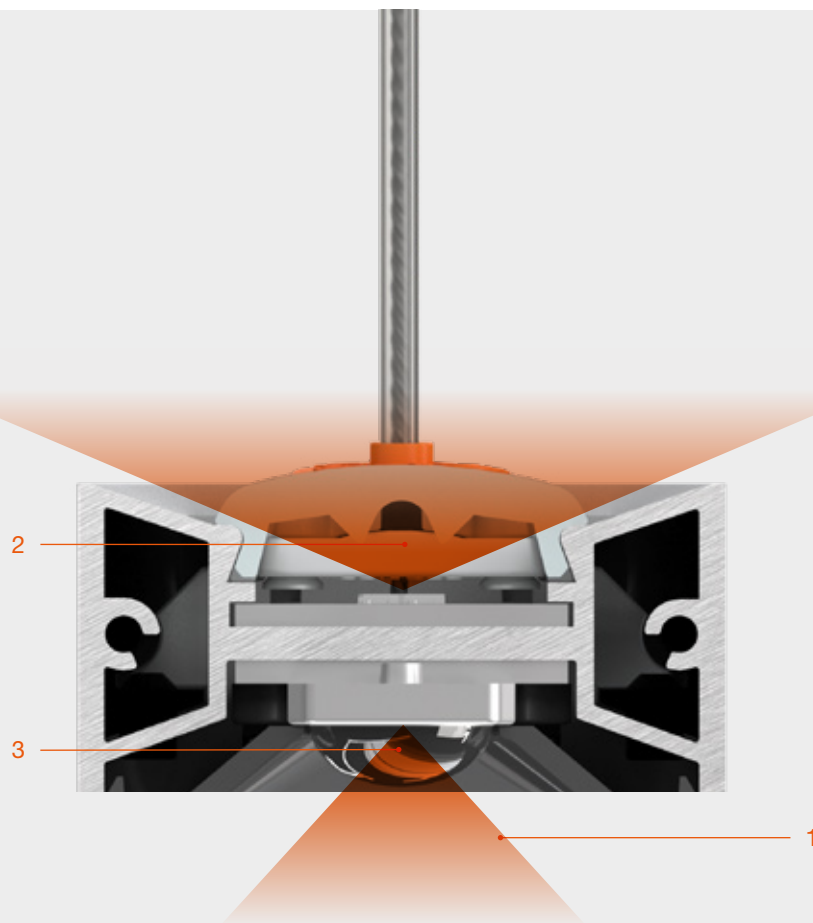

1 Angle anti-éblouissement extrême, sans pour autant renoncer aux dimensions ultra-compactes et aux valeurs de rendement élevées. Extreme shielding angle that does not compromise the ultra-compact dimensions and high efficiency values.

2 PCB LED intégré. Integrated LED PCB.

3 Lentille primaire texturée. Textured primary lens.





Enjoliveur pour installation avec appareillage à distance.

Embellishment for installation with remote equipment.

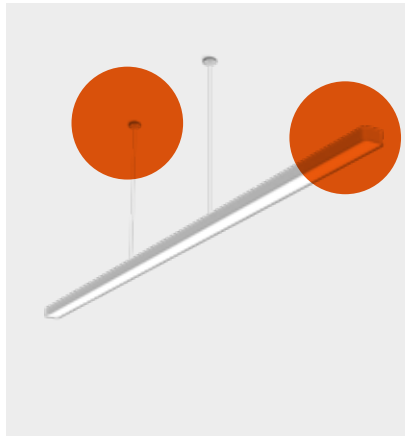

Le diffuseur opale spécial qui complète le luminaire, caractérisant l'émission directe, assure une uniformité maximale et une distribution pratiquement lambertienne.

The special opal diffuser that completes the luminaire, characterizing the direct emission, ensures maximum uniformity and a practically Lambertian distribution.

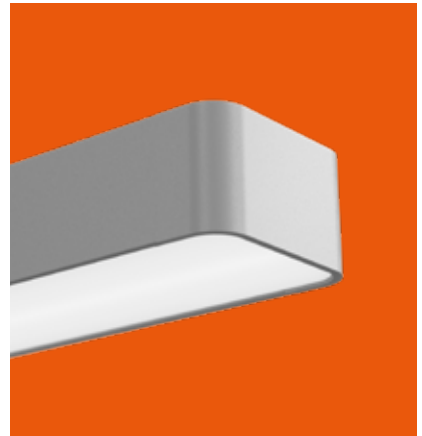

Malgré des dimensions ultra compactes et la proximité des points LED par rapport au diffuseur, il offre une distribution homogène de la lumière. Les points LED restent invisibles.

Although its dimensions are extra compact and the LED tips are close to the diffuser, it offers homogeneous light distribution. The LED tips are not visible.

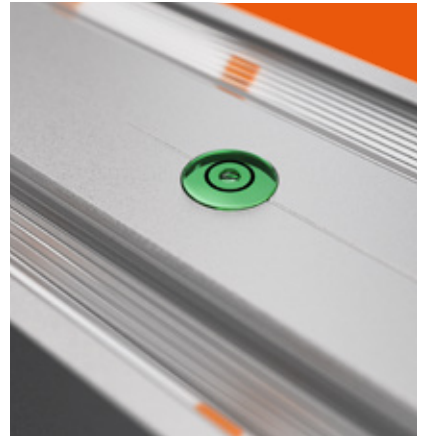
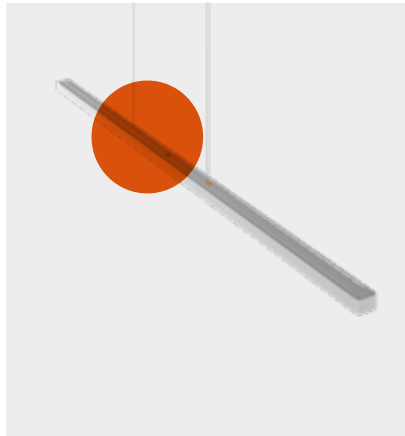

Détail du câble coaxial qui assure la connexion électrique et fait office de câble de suspension.

Detail of the coaxial cable that forms the electrical connection and can also be used for suspending.

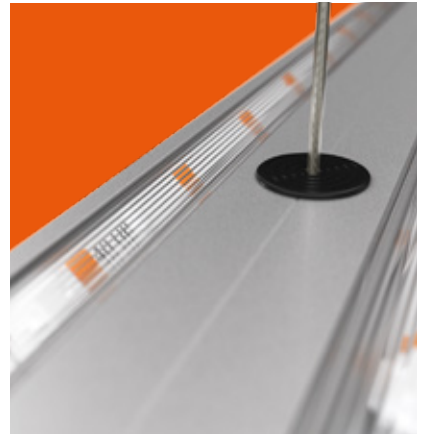



SUPER LINE
UP&DOWN
INDIRECT



TOP LED
58W

SUPER LINE
UP&DOWN
DIRECT



TOP LED
58W

SUPER LINE
DOWN



TOP LED
38,6W

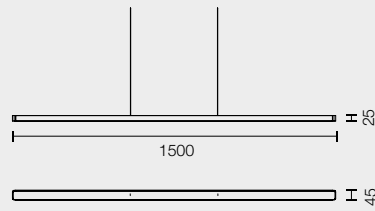

40 Blanc
40 White

02 Gris
02 Grey

14 Noir
14 Black

ET Laiton Brossé
ET Brushed Brass

EU Or Rose Brossé
EU Brushed Rose Gold

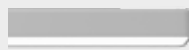
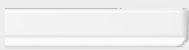

Flood
Up&Down



Flood

SUPER LINE PRO
UP&DOWN

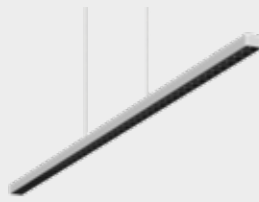

TOP LED
60W

SUPER LINE PRO
DOWN



TOP LED
40W

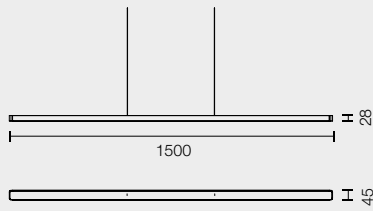

40 Blanc
40 White

02 Gris
02 Grey

14 Noir
14 Black

ET Laiton Brossé
ET Brushed Brass

EU Or Rose Brossé
EU Brushed Rose Gold

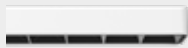

Flood
Up&Down



Flood

FLOS
CONTROL BY CASAMBI



KAP

KAP

KAP

KAP

KAP

KAP

KAP

KAP

KAP

KAP

KAP

Collection d'appareils encastrés d'intérieur offrant des solutions avec des LED de dernière génération mais aussi avec des sources lumineuses traditionnelles. Large choix de dimensions et de finitions garantissant une parfaite intégration dans tous les intérieurs. Corps optique conçu pour un grand confort visuel.

A collection of recessed elements for interior installations that include avant-garde LED solutions and luminaires with a traditional light source. A wide variety of sizes and finishes that ensure a perfect integration in all environments. Optic body to ensure an excellent visual comfort.

KAP





Private House, Geneva



Un programme complet et polyvalent, capable de satisfaire d'innombrables besoins de projets grâce à l'incroyable variété de tailles, de puissances, de finitions et d'accessoires disponibles.

A complete and versatile program capable of meeting innumerable project needs thanks to the incredible variety of sizes, powers, finishes and accessories available.



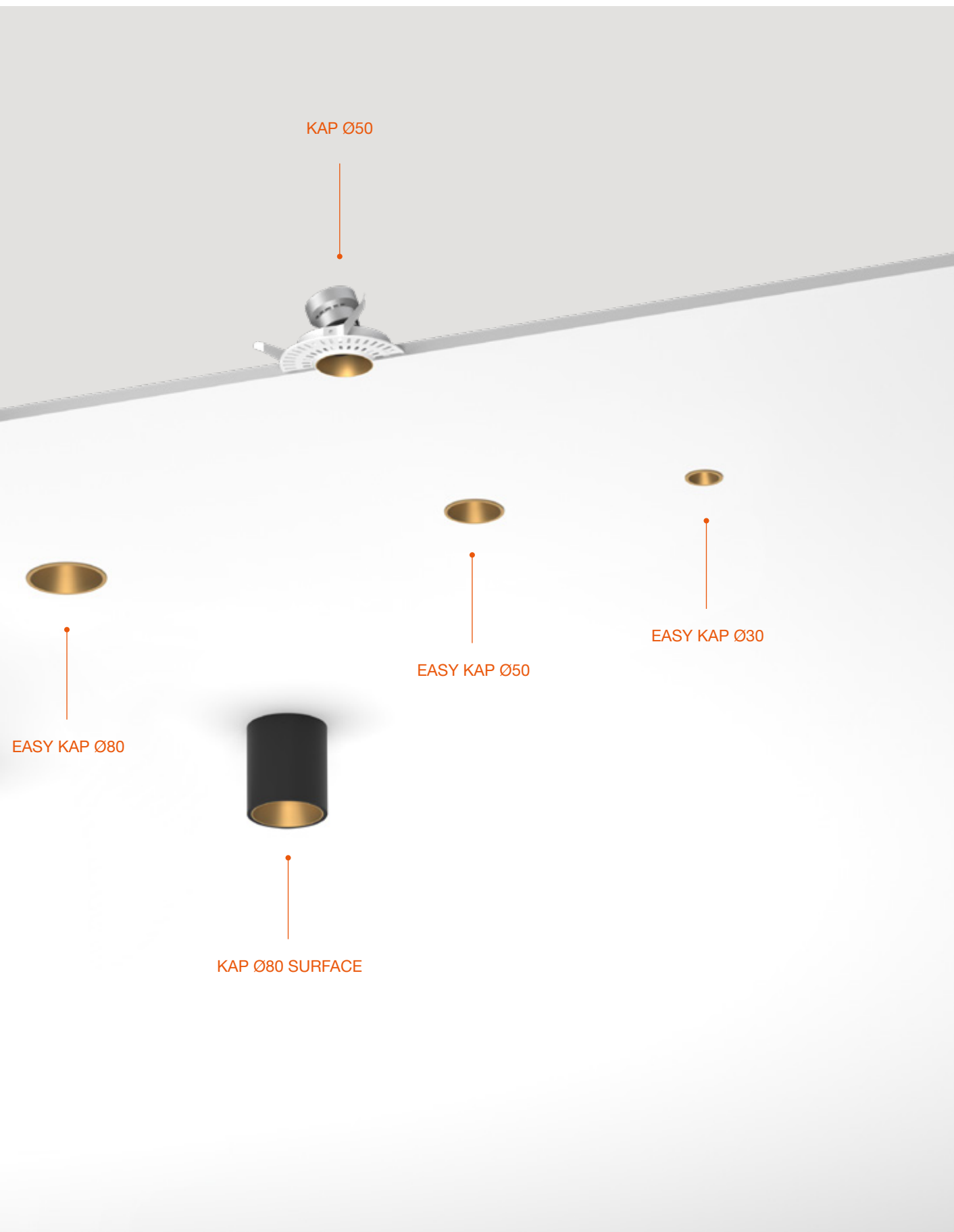





KAP

Forme et fonction sont combinées dans un dispositif technique capable de se fondre complètement dans l'architecture grâce aux détails de l'unité optique sans bords visibles.

Form and function are combined in a technical device that completely merges with the architecture thanks to the details of the optical unit with no visible edges.

1 Un radiateur pour le contrôle de la température est contenu dans le corps principal de l'appareil.
The main body of the luminaire contains a radiator for temperature control.

2 Le corps contient un diffuseur en matériau thermoplastique permettant d'obtenir une parfaite distribution de la lumière sur les surfaces horizontales.
The housing includes a thermoplastic diffuser which ensures a perfect light distribution on horizontal surfaces.

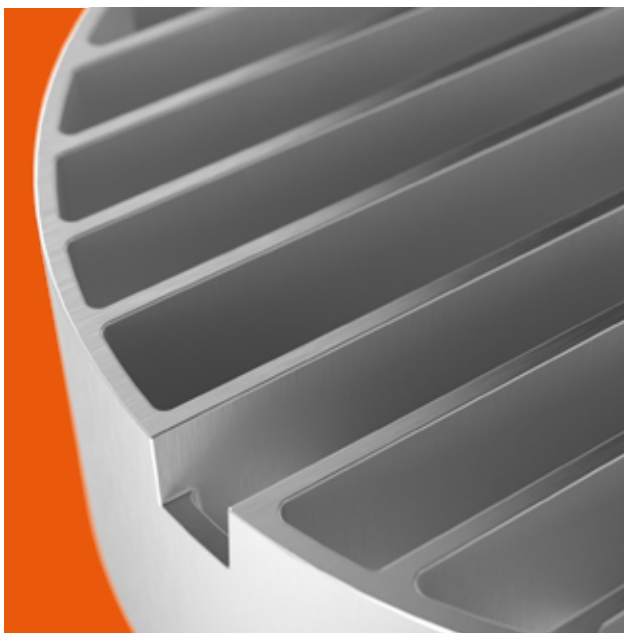

1



2

EASY KAP

Les performances et les finitions de Kap appliquées à un modèle plus polyvalent, plus maniable et plus facile à installer grâce au groupe optique à bord visible.

The performance and finishes of Kap are applied to a more versatile and manageable model that increases the simplicity of installation thanks to the optical unit with a visible edge.

3 Dissipateur à haut rendement en aluminium moulé sous pression.
High performance sink in die-cast aluminum.

4 Un mince rebord saillant aide à dissimuler les éventuelles imperfections du plafond et qui garantit une installation sans faille.

A thin, protruding edge helps hiding any imperfections in the ceiling and guarantees a flawless installation.





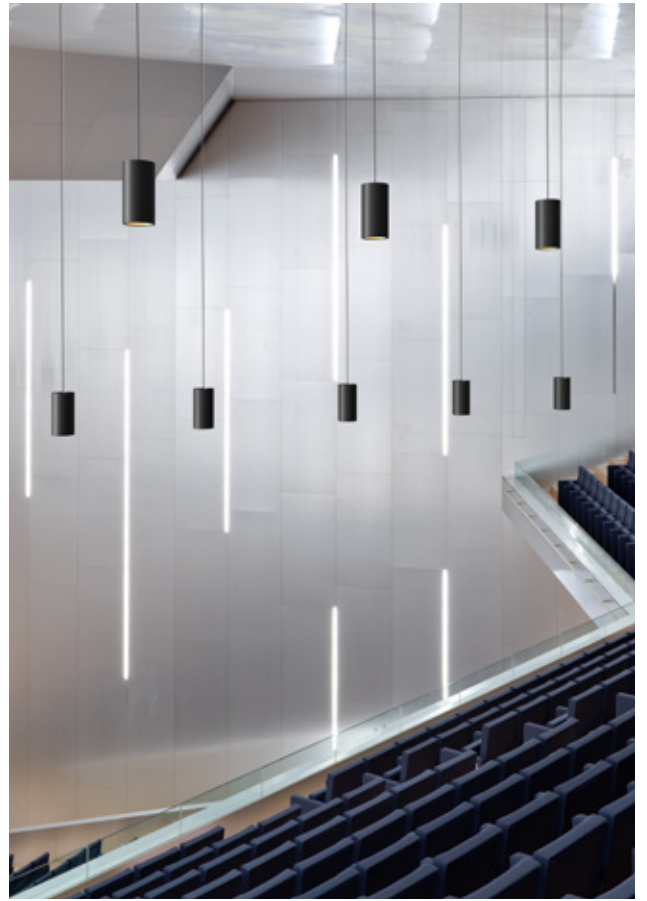





KAP dim to warm représente l'état de l'art dans le contrôle de la température de couleur. La technologie exclusive dim to warm couvre une gamme entre 2850K et 1800K avec une performance de couleur optimale grâce au contrôle synchronisé impeccable de l'intensité lumineuse et de la température de couleur. Le système simule la régulation des ampoules à incandescence traditionnelles en exploitant au mieux la technologie LED actuelle.

KAP dim to warm represents the state of the art in color temperature control. The unique dim to warm technology covers a range from 2850K to 1800K with optimal color performance thanks to a flawless synchronized control of light intensity and color temperature. The system simulates the regulation of traditional incandescent lamps exploiting the best current LED technology.

1800K  2850K



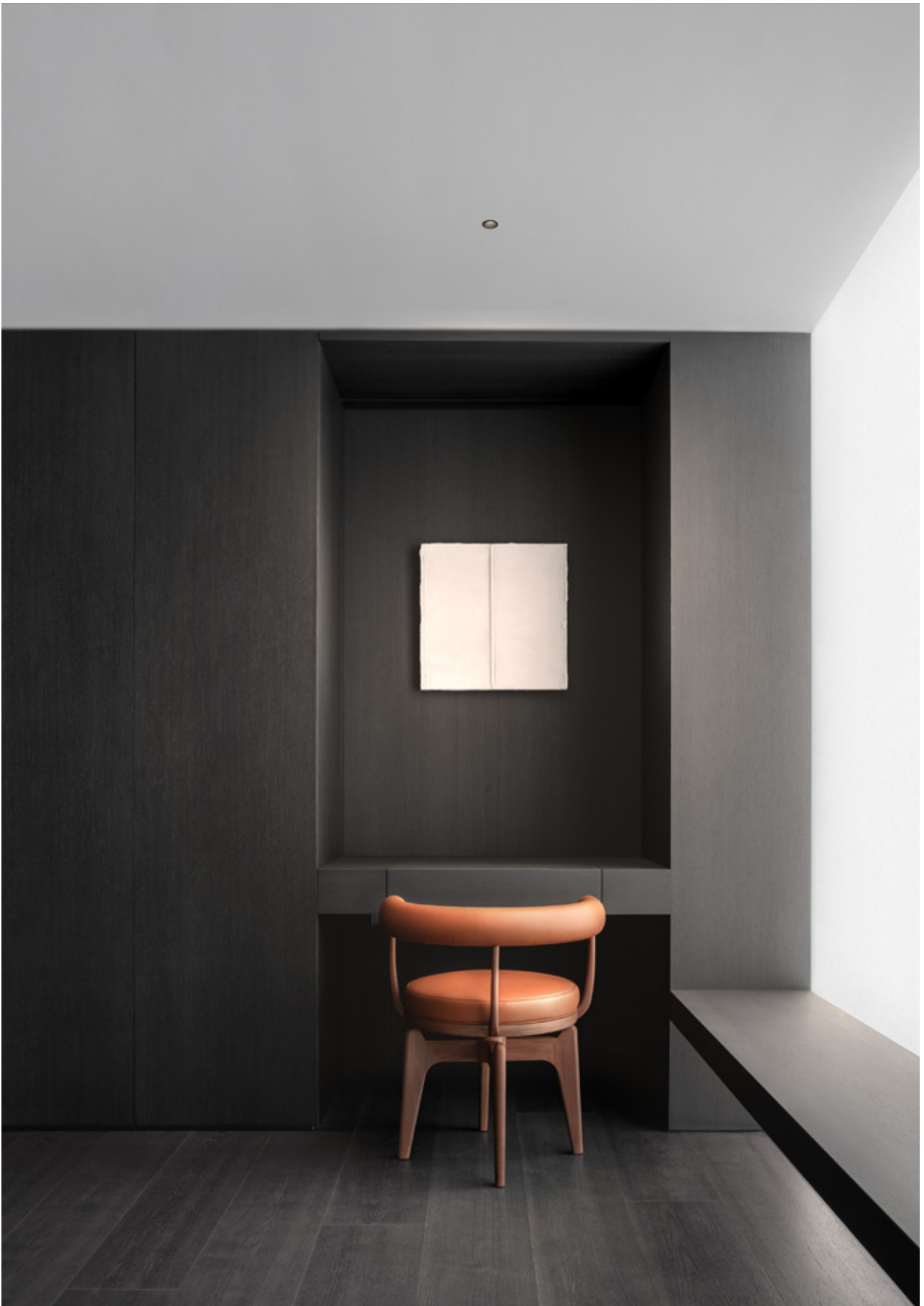

EASY KAP 30 FIXED

La taille 30 d'Easy Kap est le modèle le plus petit de toute la famille KAP. Un petit point lumineux au plafond, élégant et discret, pour un éclairage général ou d'accentuation, avec une présence minimale dans l'espace.

The Easy Kap 30 is the smallest model in the KAP product family. This is a small, sleek, understated ceiling light for general or focused lighting, taking up minimum space.

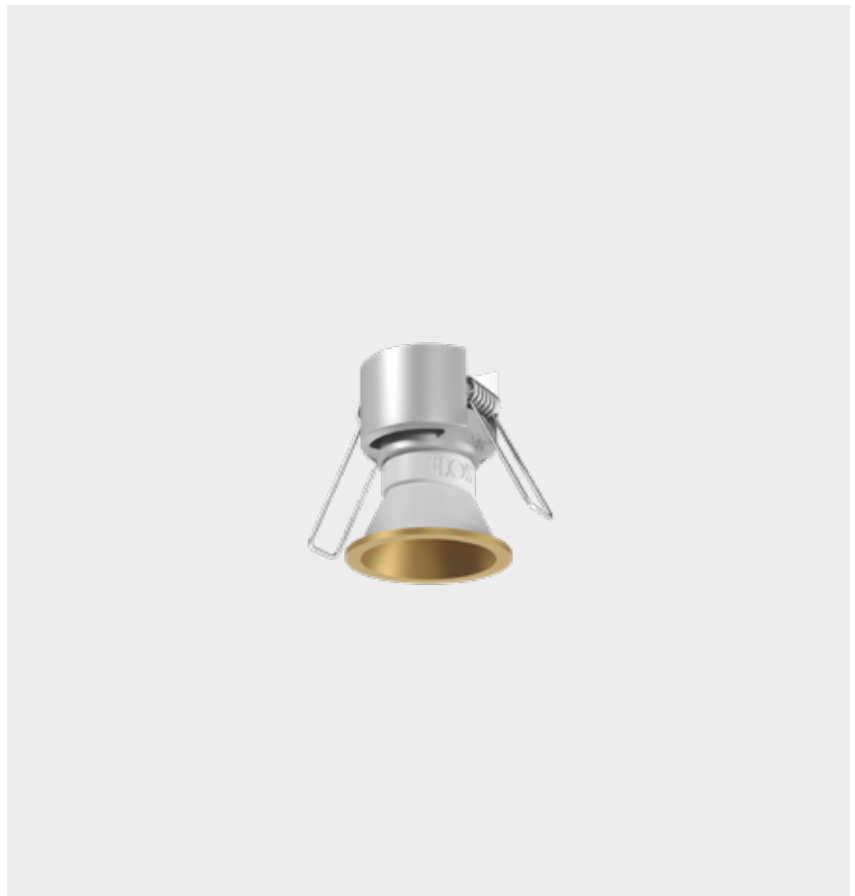

EASY KAP 30 ADJUSTABLE

Avec la variante réglable d'Easy Kap 30, le faisceau lumineux peut être légèrement ajusté d'un angle de 17° dans les deux axes. Une légère directivité qui permet à ce modèle de fournir le détail différentiel dans l'éclairage du projet.

With the adjustable Easy Kap 30 model the light beam can be slightly adjusted by an angle of 17° on both axes. The slight directionality featured in this model brings distinctive detail to the design of the light.

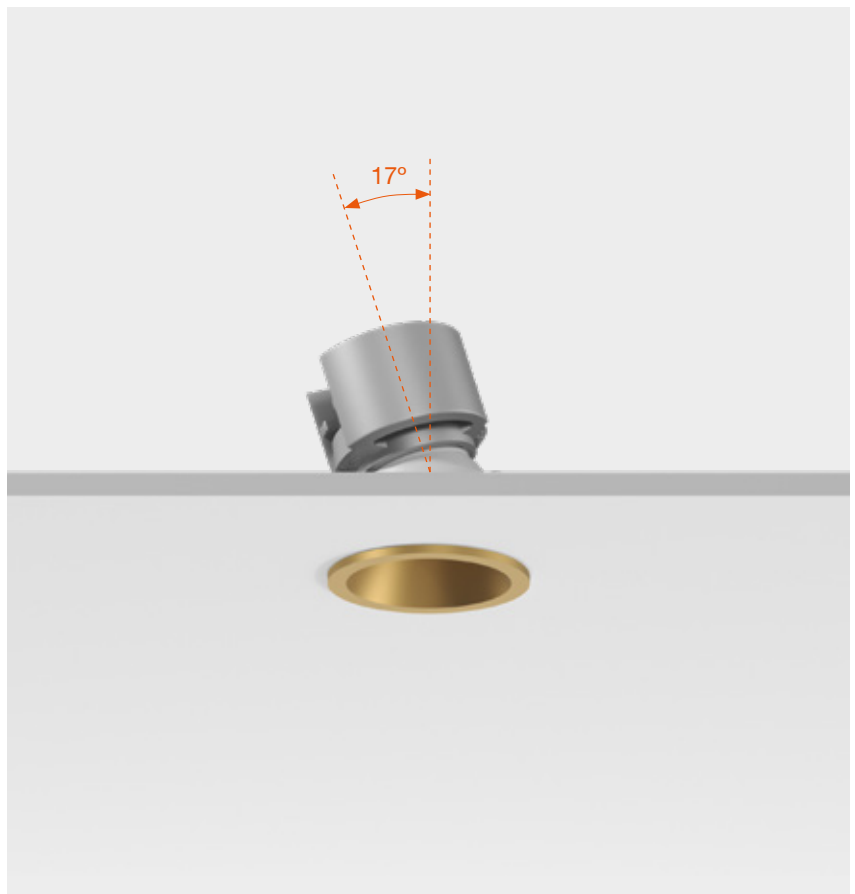







KAP 50

Kap 50 complète la gamme avec une solution compacte et à haut rendement qui, grâce aux technologies LED de nouvelle génération, garantit des performances optimales malgré sa taille réduite.

Kap 50 completes the range with a compact, high-performance solution that, thanks to new-generation LED technologies, guarantees optimal performance despite its small dimensions.



KAP 50 ADJUSTABLE

Des dimensions compactes et une grande flexibilité grâce aux versions rotatives mini, parfaites pour des applications dans des hôtels et des maisons.

Compact dimensions and great flexibility thanks to the mini adjustable versions, perfect for home and hotel applications.





Hotel Brooklyn, New York

Les versions encastrées de KAP nécessitent des accessoires pour des installations individuelles (cadres de pré-montage) disponibles en version Trim et No Trim (selon modèle, veuillez nous consulter). Cette méthode d'installation encastrée n'est valable que pour les plafonds en carton-plâtre.

The recessed versions of KAP require individual installation accessories (pre-installation frames) available in Trim and No Trim versions (depending on the models, please consult). This recessed installation method is valid only for plasterboard ceilings.

Boitier de réservation pour installation sur plafond en béton.

Available can for the installation in cement ceilings.



KAP SQUARE

Pour toutes les solutions de la gamme, la pureté du carré est disponible en alternative à la version classique à foyer circulaire.

For all the solutions in the range, the purity of the square is available as an alternative to the classic version with a circular spotlight.

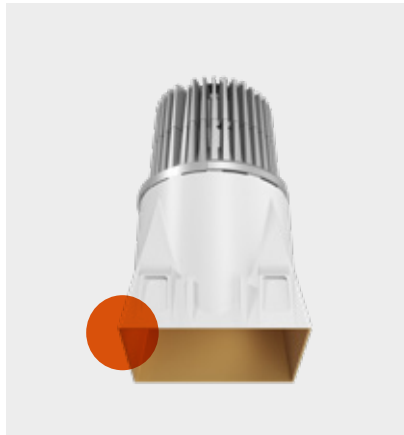

KAP ADJUSTABLE

Corps rotatif avec mécanisme de verrouillage des focalisations intégré. Idéal en combinaison avec des optiques intensives pour des contrôles de lumière flexibles et à fort contraste.

Rotary body with integrated focal points locking mechanism. Perfect combined with intensive optics for flexible, high-contrast lighting controls.

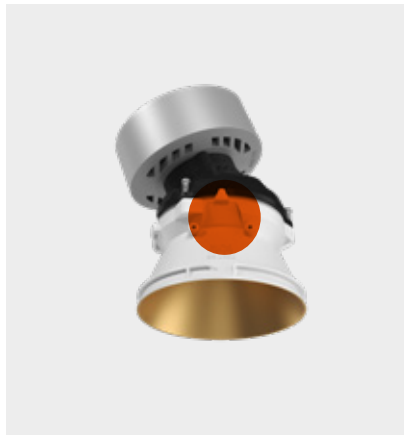

KAP DEEP

Optique à double foyer, idéale pour gérer les environnements à double volume ou à grande hauteur.

Dual-focus optics, ideal for managing environments with double volumes or high heights.



KAP WALL-WASHER

Optique asymétrique pour un éclairage uniforme des surfaces verticales. Donne à la pièce de la profondeur et augmente la luminosité perçue.

Asymmetric optic for uniform lighting of vertical surfaces. Provides depth and greater perceived brightness to the room.

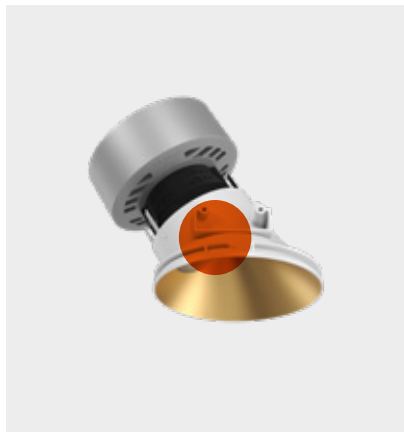



Arclinea Headquarters,
Italy



United Nations,
Geneva



Avec le même design que pour le Kap 80, le Kap 80 Plus se distingue par un dissipateur exclusif dédié qui améliore les performances du produit sans altérer la qualité de l'effet lumineux.

With the same design as Kap 80, Kap 80 Plus stands out thanks to the exclusive dedicated sink, which improves the product's performance without altering the quality of the lighting effect.

Tous les Easy Kap 80 LED sont fournis avec un diffuseur opale qui peut être installé pour augmenter le confort visuel et le blindage du luminaire.

All the Easy Kap 80 LED have an opaline diffuser that can be assembled to increase visual comfort and screening of the luminaire.

Effet No Trim grâce à un nouveau système de montage. Le montage à baïonnette permet de remplacer la lampe sans aucun outil particulier.

Total No Trim effect achieved due to a new installation system. The bayonet-based assembly allows to replace the lamp without using any particular tools.

L'appareil contient un diffuseur en matériau thermoplastique permettant d'obtenir une parfaite distribution de la lumière sur les surfaces horizontales.

The luminaire includes a thermo-plastic diffuser which ensures a perfect light distribution on horizontal surfaces.

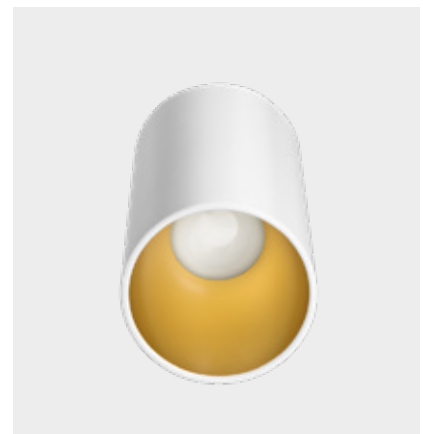

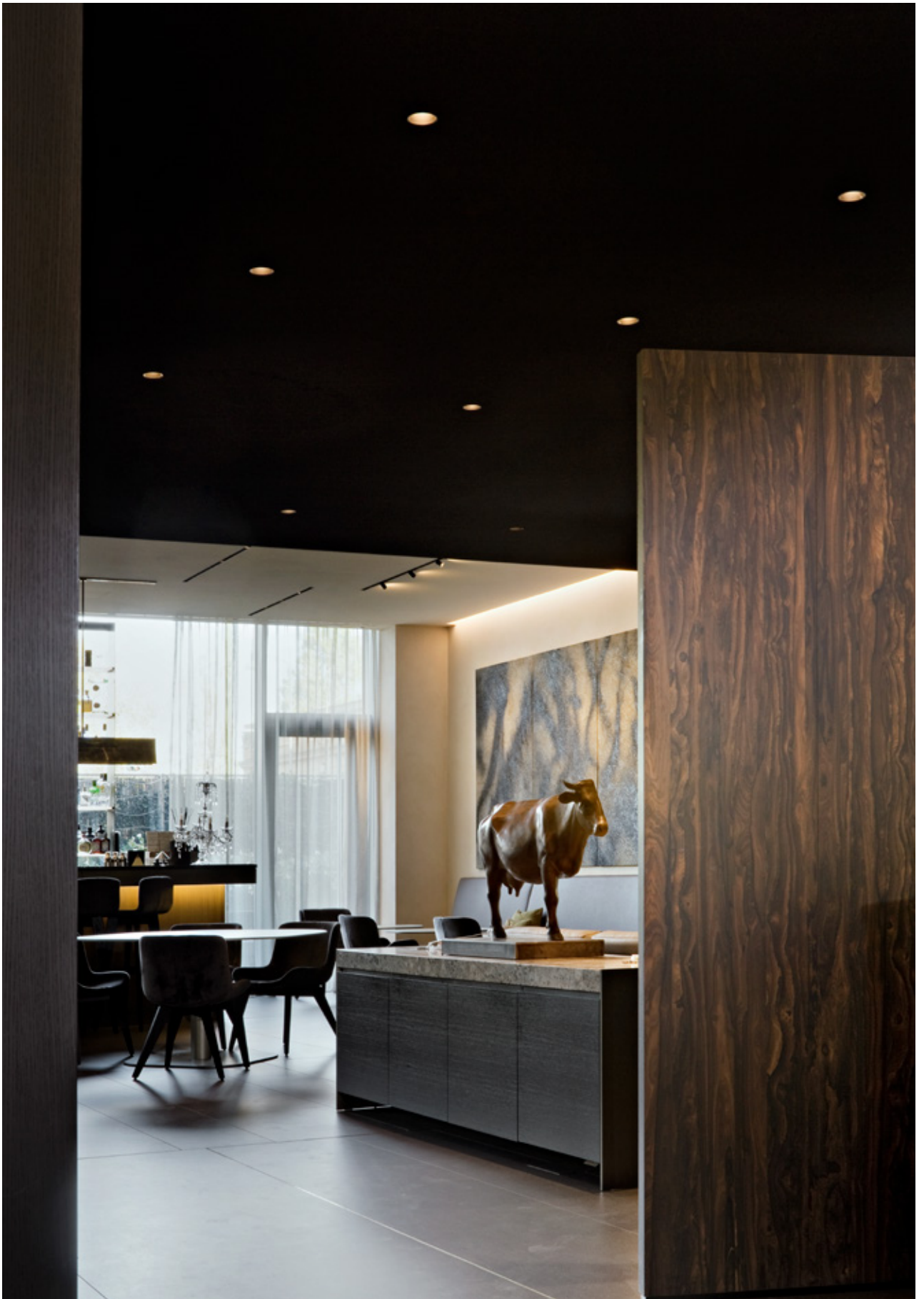

Viu Hotel, Italy



EASY KAP Ø30
FIXED



POWER LED
UP to 3,2W

EASY KAP Ø30
ADJUSTABLE



EASY KAP Ø50
FIXED



LED ARRAY
7,5W

EASY KAP Ø50
ADJUSTABLE



EASY KAP 80 / EASY KAP 80 PLUS
FIXED



LED ARRAY
UP to 13W

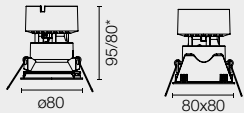

Easy Kap Plus / Easy Kap*

EASY KAP 80 / EASY KAP 80 PLUS
ADJUSTABLE



LED ARRAY
Dim-To-Warm
13W



Easy Kap Plus / Easy Kap*

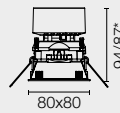

LED
QR-CBC 51
GX5.3

EASY KAP 80 / EASY KAP 80 PLUS
WALL-WASHER



LED
PAR 16
GZ10



Easy Kap Plus / Easy Kap*

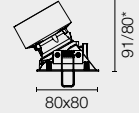

EASY KAP Ø105
FIXED



LED ARRAY
23W

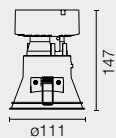

EASY KAP Ø105
ADJUSTABLE



LED
QR-CBC 51
GX5.3

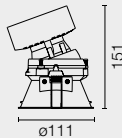

EASY KAP Ø105
WALL-WASHER



LED
PAR 16
GZ10

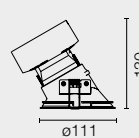

KAP Ø50
FIXED



KAP Ø50
ADJUSTABLE



LED ARRAY
7,5W



KAP 80 / KAP 80 PLUS
FIXED

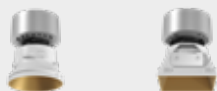

LED ARRAY
UP to 13W

LED ARRAY
Dim-To-Warm
13W

KAP 80 / KAP 80 PLUS
WALL-WASHER



LED
QR-CBC 51
GX5.3

LED
PAR 16
GZ10

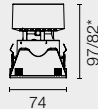
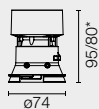

Kap Plus / Kap*

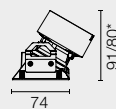
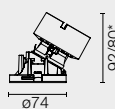

Kap Plus / Kap*

KAP 80 / KAP 80 PLUS
ADJUSTABLE



LED ARRAY
UP to 13W

LED ARRAY
Dim-To-Warm
13W

LED
QR-CBC 51
GX5.3

LED
PAR 16
GZ10

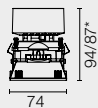
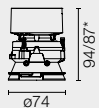

Kap Plus / Kap*

KAP Ø105
FIXED



LED ARRAY
23W

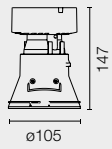

KAP Ø105
ADJUSTABLE



LED
QR-CBC 51
GX5.3

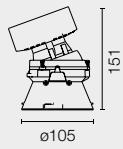

KAP Ø105
WALL-WASHER



LED
PAR 16
GZ10

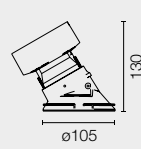

KAP Ø105
DEEP



LED ARRAY
23W

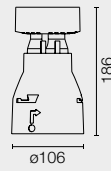

KAP 105
SQUARE



PHOSPHOR LED
17W LED
QR-CBC 51
GX5.3

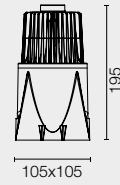

Spot



Medium



Flood



Wide Flood



Wall-Washer

□ B1 Blanc
B1 White



■ GL Or Mat
GL Matt Gold



■ 74 Noir
74 Black



■ EQ Cuivre
EQ Copper



<p>ROUND Ø80</p>	<p>CEILING Ø100</p>	<p>WALL Ø100</p>	<p>SUSPENSION Ø100</p>
<p>SQUARE 80</p>			
<p>LED ARRAY 9,2W</p>	<p>POWER LED 9W</p>		



Spot



Medium



Flood

KAP 80 ROUND / SQUARE

Externe / Outside

11 Blanc
11 White
 AN Noir
AN Black
 18 Deep Brown
18 Deep Brown

Interne / Inside

Blanc
White
 Or Mat
Matt Gold
 Cuivre
Copper
 Noir
Black



KAP Ø100

Externe / Outside

11 Blanc
11 White
 AS Aluminium Brossé
AS Brushed Aluminium
 AN Noir
AN Black
 B3 Brun
B3 Brown

Interne / Inside

Blanc
White
 Or Mat
Matt Gold
 Cuivre
Copper
 Noir
Black

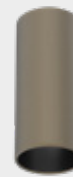

FLOS
CONTROL BY CASAMBI



c1 C

c1 c1 c1 c1 c1 c1 c1
c1 c1 c1 c1 c1 c1 c1

1 C1
C1

La simplicité du cylindre cache un mécanisme intelligent qui permet d'obtenir une étonnante flexibilité du corps d'éclairage.

The simplicity of the cylinder hides an intelligent mechanism that allows for an amazing flexibility of the lighting body.

C1



La gamme propose deux tailles conçues pour des applications au plafond ou au mur. La gamme de puissances disponibles et le kit optique dédié font du C1 un produit idéal pour les applications dans des hôtels et des maisons.

The range consists of two sizes, designed for ceiling or wall applications. The range of available powers and the dedicated optics kit make C1 ideal for applications in hotels and homes.

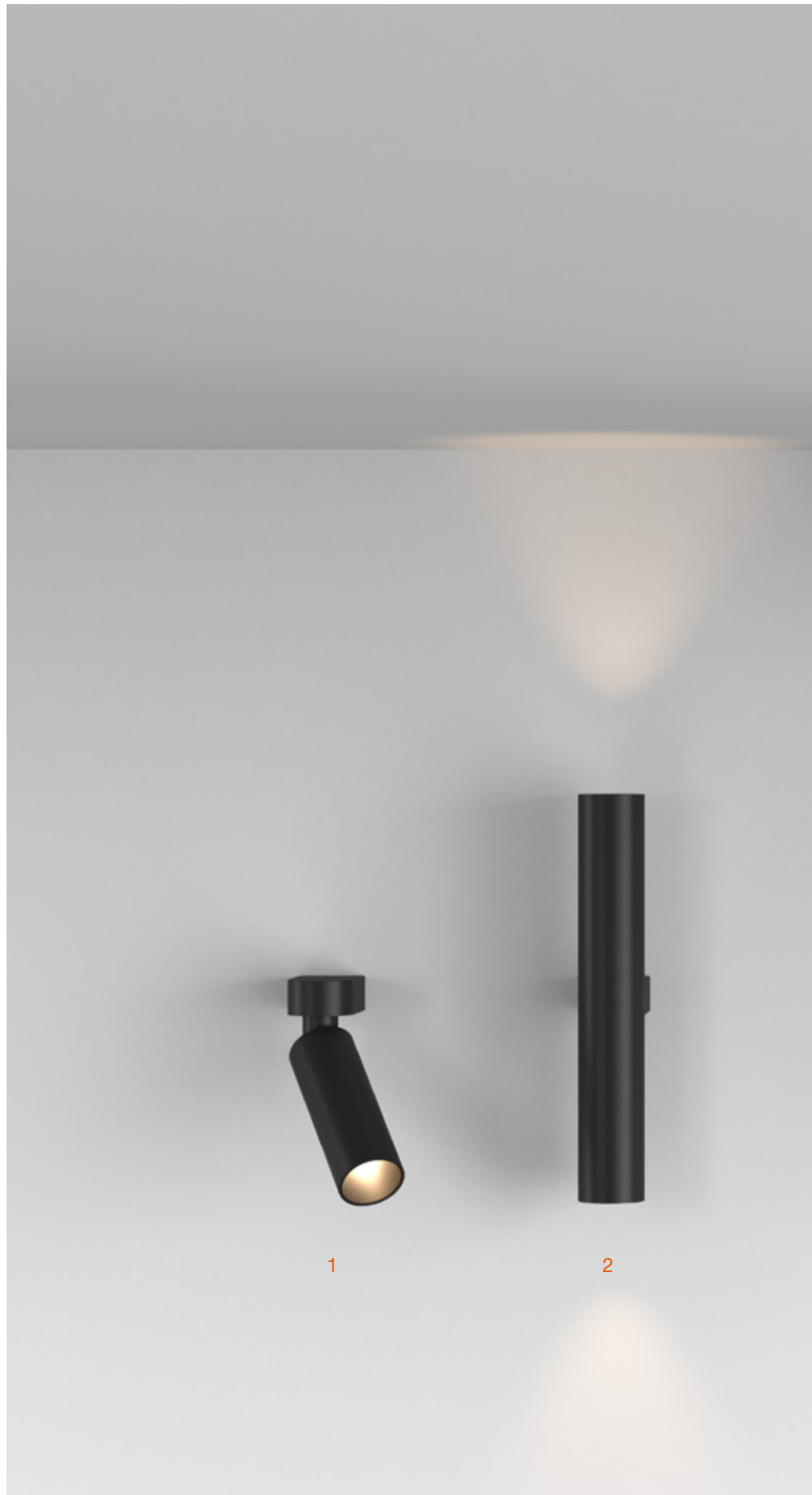

- 1 WALL DOWN
- 2 WALL UP&DOWN
- 3 CEILING









Le groupe optique, placé vers l'arrière sur le corps, cache la source de lumière de la vue tout en contrôlant l'éclairage direct pour un effet de confort total. Le nœud spécial, intégré dans le corps du produit, permet de le retirer et de le diriger sur la base à 60° dans l'axe vertical et à 355° dans l'axe horizontal.

The optic group, placed far back on the body, hides the light source from the eye while controlling the direct illuminance for an absolute comfort effect. The special node, integrated into the product's body, allows it to be removed and directed at the base 60° on the vertical axis and 355° on the horizontal axis.



Les versions murales sont disponibles pour des applications à émission simple ou double. Les lentilles du produit garantissent une distribution de la lumière douce et diffuse pour l'éclairage général de la pièce.

The wall-mounted versions are available for single and double emission applications. The lenses of the product guarantee a soft and diffuse light distribution for general room lighting.



Une émission ponctuelle concentrée est disponible pour les applications où une lumière de lecture est nécessaire. Elle est idéale pour créer un cadre relaxant pendant la nuit.

In applications where reading light is required, a concentrated spot emission is available, which is ideal for creating a relaxing scene during the night hours.







Villa La Saracena



WALL UP&DOWN
SMALL



LED ARRAY
12W

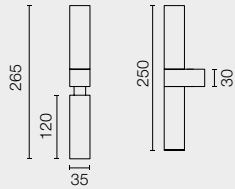

WALL DOWN
SMALL



LED ARRAY
6W

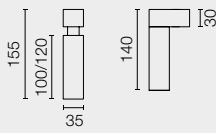

CEILING
SMALL



LED ARRAY
6W



WALL UP&DOWN
LARGE



LED ARRAY
UP TO 28W

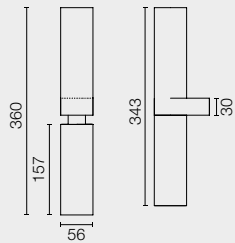

WALL DOWN
LARGE



LED ARRAY
UP TO 14W

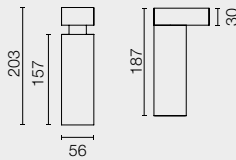

CEILING
LARGE



LED ARRAY
UP TO 14W



□ DY Blanc
DY White

■ DR Anthracite
DR Anthracite

■ EQ Cuivre Brossé
EQ Brushed Copper

■ ER Acier Brossé
ER Brushed Steel

■ ES Bronze Brossé
ES Brushed Bronze



Peut être pivoté à 180° et orienté à 60°.
Can be rotated 180° and swivelled 60°.

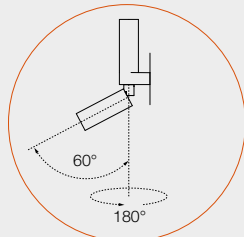

Wall

Peut être pivoté à 355° et orienté à 60°.
Can be rotated 355° and swivelled 60°.

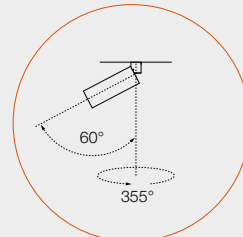

Ceiling



Spot



Medium



Flood



Wide Flood

FLOS
CONTROL BY CASAMBI



FIND

ME

ME

FIND

FIND

ME

ME

FIND

FIND

ME

ME

FIND

Projecteur d'éclairage intérieur avec source lumineuse LED. Disponible en trois versions : version Mono Point (0, 1 et 2) -constituée d'un corps cylindrique amovible qui, en position haute, fait office de downlight et, en position basse, devient un projecteur orientable-, version Find Me 3 Track et version Suspension.

Interior lighting projector with LED light source. Available in three versions: Mono Point version (0, 1 and 2) -consisting of a removable cylindrical body that acts as a downlight when set in its upper position and becomes an adjustable projector when set in its lower position-, Find Me 3 Track version and Suspension version.

FIND ME

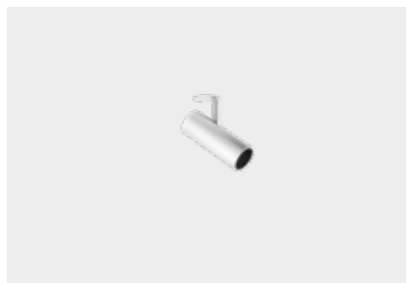

Une icône intemporelle. Find Me réinterprète l'archétype du projecteur traditionnel à travers des détails d'installation élégants et raffinés qui le rendent unique et inimitable.

A timeless icon. Find Me reinterprets the traditional projector archetype through stylish and refined installation details that make it unique and inimitable.





Cet ingénieux dispositif d'intérieur, encastré et rotatif, renferme un design ultraminimaliste. Find Me 0 réduit au minimum la taille du projecteur et réinterprète le talent de son grand frère Find Me à petite échelle.

This ingenious, recessed and adjustable indoor device features an ultra-minimalist design. Find Me 0 minimizes the size of the projector, reinterpreting the talent of its big brother Find Me on a small scale.



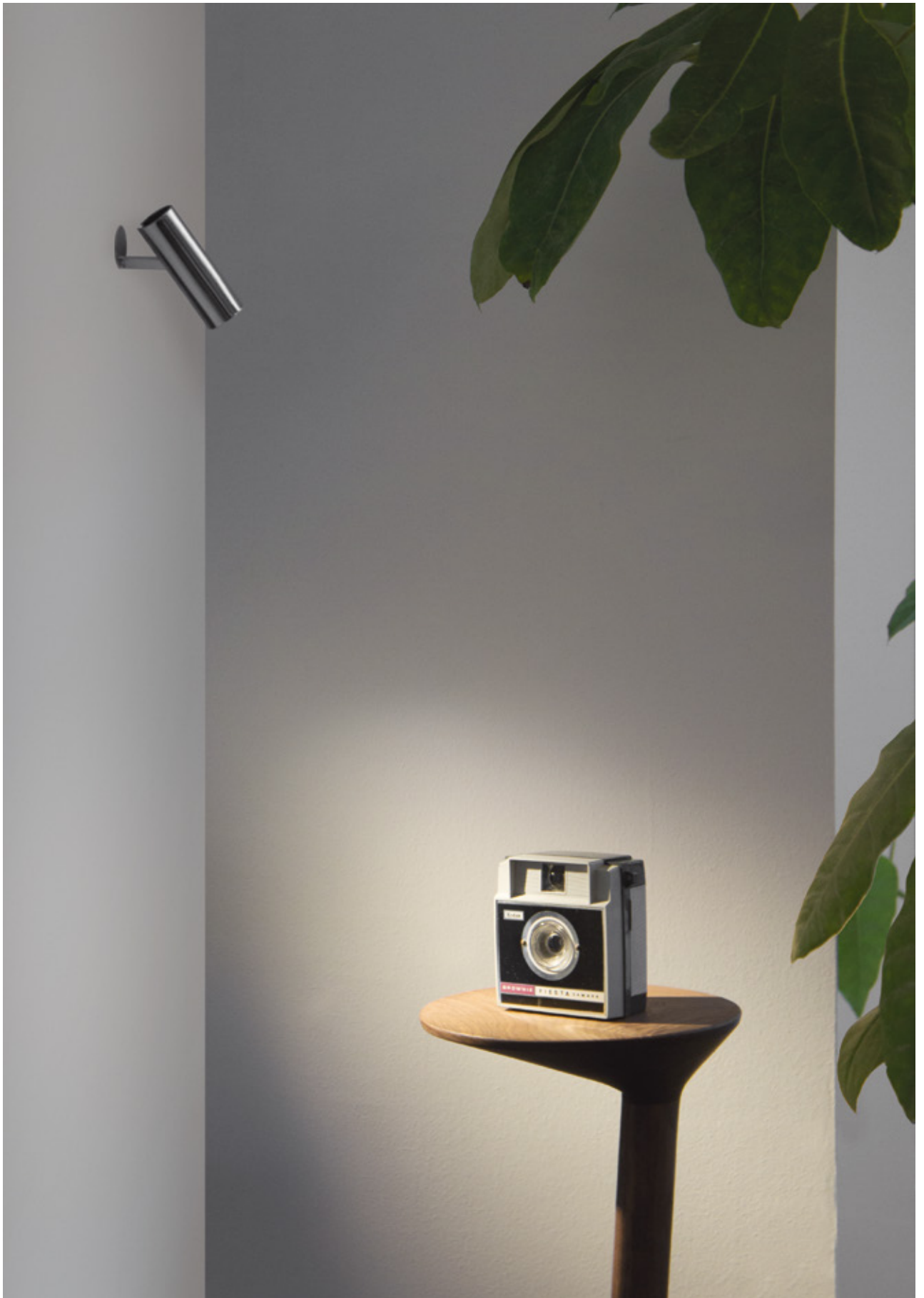



Il Sereno Hotel, Italy

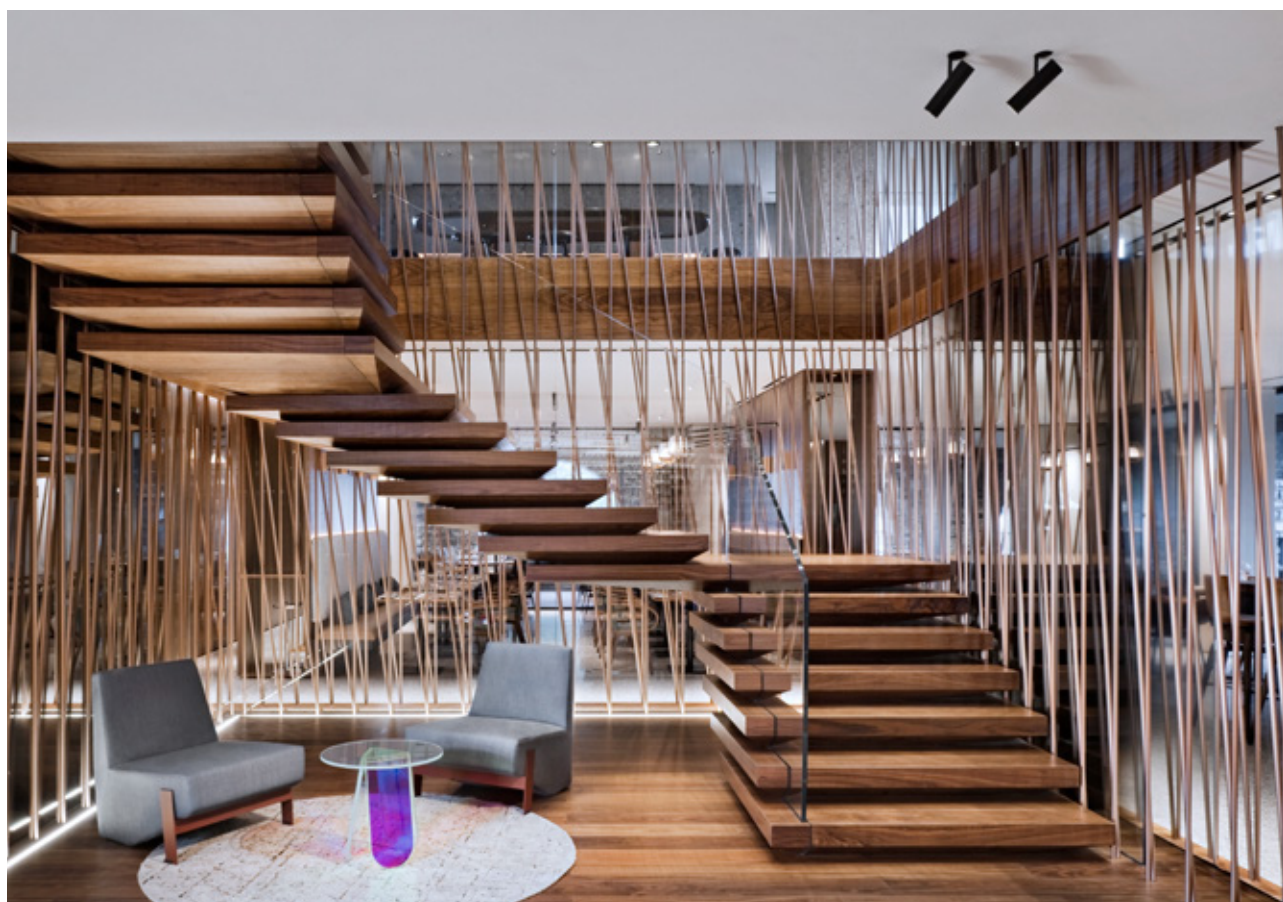
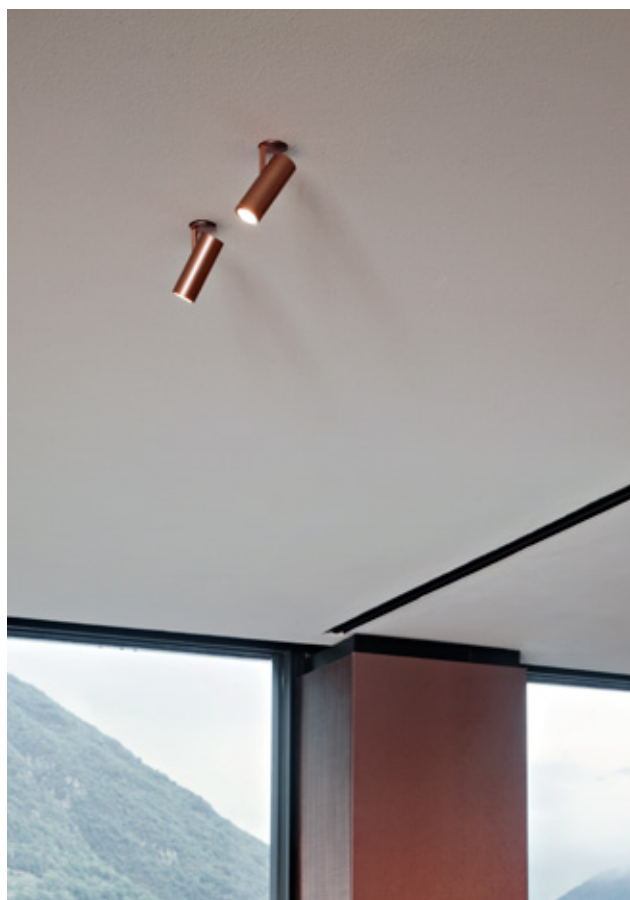



Orientable et basculant grâce à sa base rotative à 360° et à son bras en zamak orientable jusqu'à 70°.

Directional and tilting thanks to its base with 360° rotation capacity and to its arm made of zamak, directional up to 70°.

Système de déplacement par ergots élastiques sur une glissière crantée permettant de dissimuler les projecteurs, afin qu'ils soient parfaitement intégrés dans l'environnement.

An adjustment system with elastic flanges on a toothed guide, permits concealing the spotlights, thus becoming totally integrated into the environment.



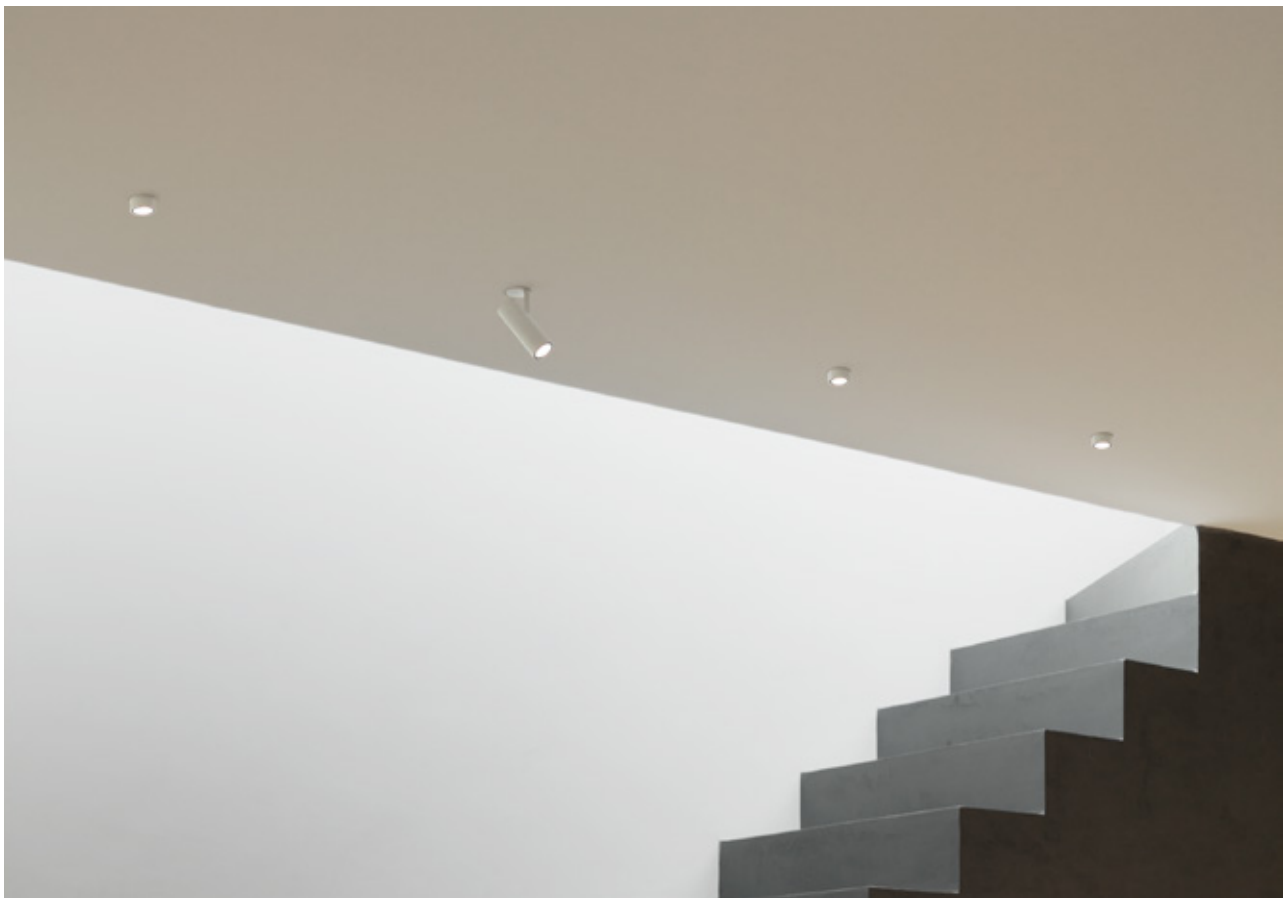

Hotel Colombo, Italy
Top



Carbonado Energy,
South Africa

FIND ME 0
TRIM / NO TRIM

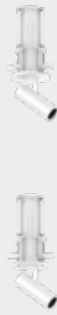

POWER LED
3,5W

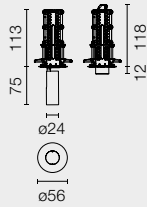

FIND ME 1
TRIM / NO TRIM

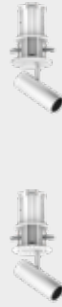

POWER LED
6W

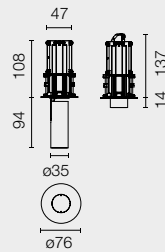

FIND ME 2
TRIM / NO TRIM



POWER LED
10W

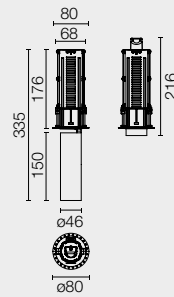

FIND ME 3
TRACK



POWER LED
28W

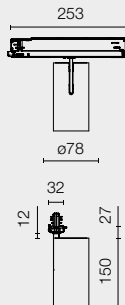

FIND ME 1
SUSPENSION



POWER LED
6W



FIND ME MONO POINT *

□ 30 Blanc
30 White



◻ 06 Chromé
06 Chrome



■ 14 Noir
14 Black



TRACK **

□ 30 Blanc
30 White



■ 14 Noir
14 Black



FIND ME SUSPENSION

□ 30 Blanc
30 White



◻ 06 Chromé
06 Chrome



■ 14 Noir
14 Black



Couleurs du Cylindre Anti-éblouissement (compris)
Screening Cylinder Colours (included)

■ Orange
Orange



■ Violet
Violet



■ Noir
Black



Peut être pivoté à 360° et orienté à 70° * / 90° **.
Can be rotated 360° and swivelled 70° * / 90° **.

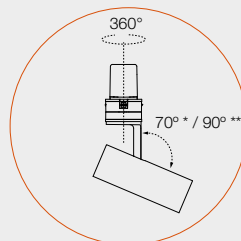

FLOS
CONTROL BY CASAMBI



UT

C

UT UT
UT UT

F

H

UT

D

UT

Collection de projecteurs LED à forte puissance au design minimaliste et élégant. Grande variété de solutions, avec sources lumineuses et optiques permettant de répondre à toutes les exigences d'éclairage. Installation possible sur rail triphasé pour une plus grande flexibilité ou au plafond pour une meilleure intégration dans l'architecture. Efficacité et fiabilité.

A collection of minimalist and elegant high-power LED projectors. A wide range of solutions with light sources and optics for all your lighting needs. Possibility of installing a three-phase track for maximum flexibility or ceiling installation for a better integration in the architecture. Efficiency and reliability.

UT

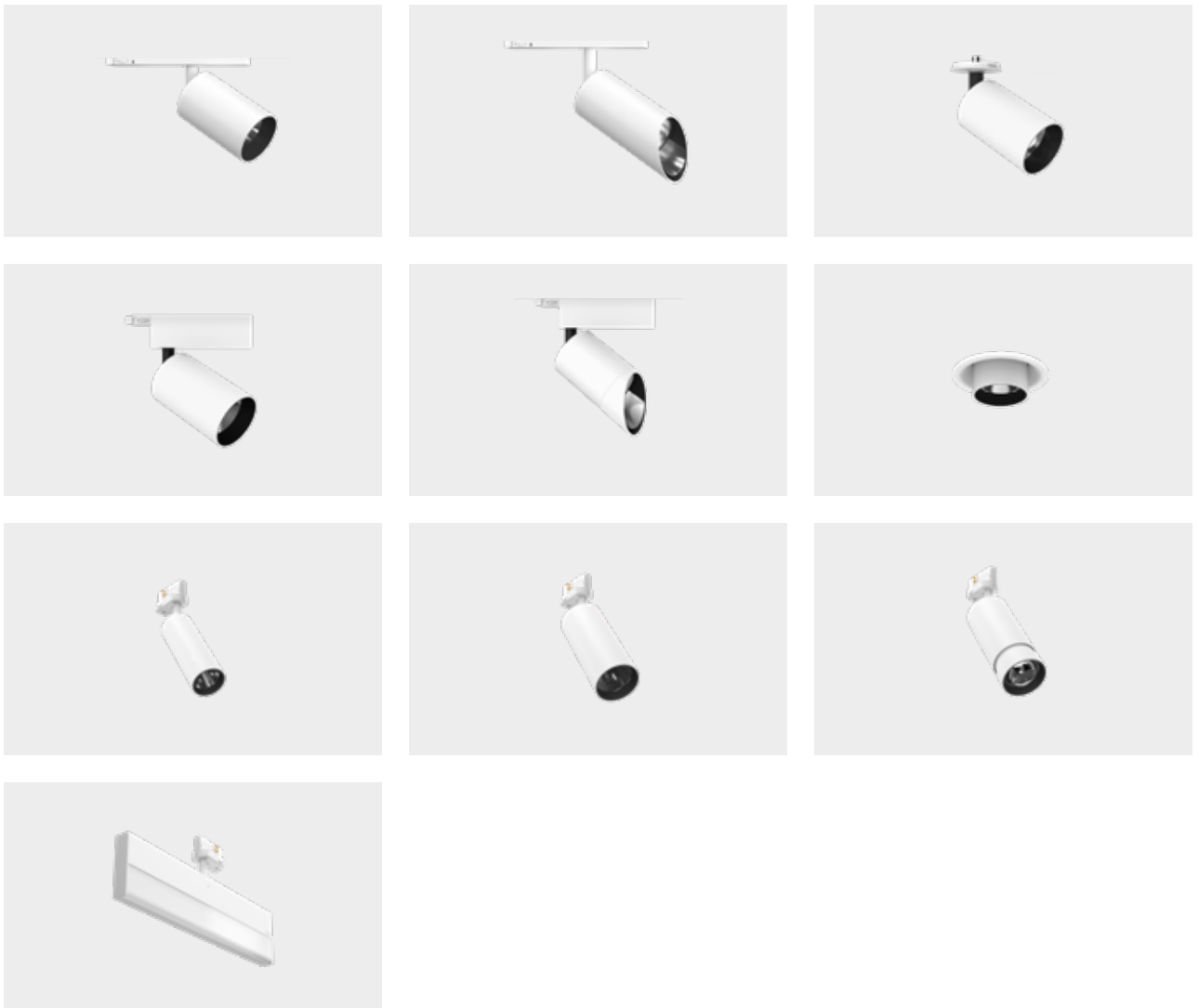



Victoria Beckham Store,
London



UT SPOT

Projecteur professionnel à haut rendement, disponible avec une large gamme d'effets lumineux.

High performance professional projector available with a wide range of lighting effects.

1 Optique multi-chip pour angles d'ouverture très serrés.
Multichip optical design to achieve very narrow beam angles.

2 Wall-washer disponible dans la version track de Ø86.
A wall-washer version is available in Ø86 track version.



1



2

UT SPOT ALL WHITE

De nouvelles versions avec la finition exclusive « all white » pour la meilleure intégration possible dans l'environnement.

New versions with the exclusive "all white" finish for the best possible integration into the environment.

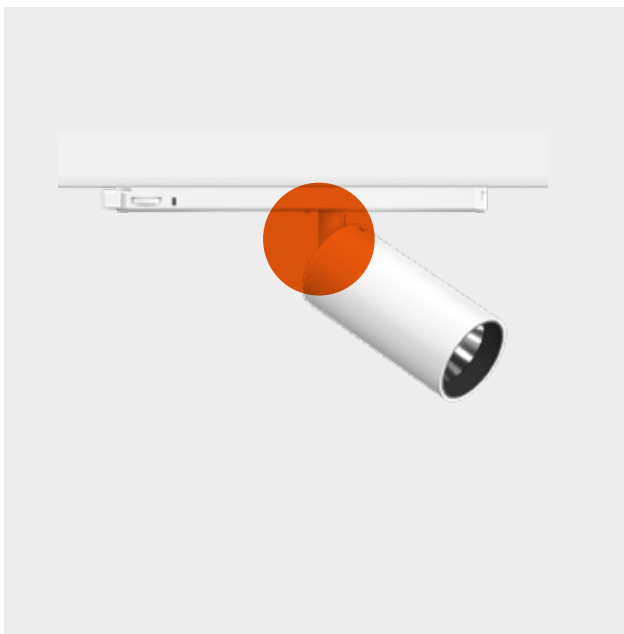

UT PRO SURFACE

Versions pour installation en surface avec base intégrée et régulateur de puissance inclus.

Versions for surface installation with integrated base and power regulator included.

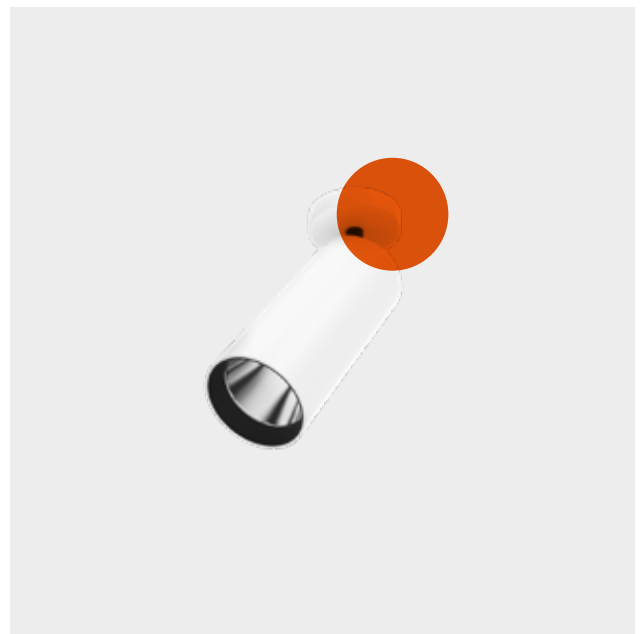



Flos Booth Euroshop Fair,
Germany



Central European University,
Budapest
Bottom

Boutek, Milan
Top

- 1 UT SPOT TRACK Ø57
- 2 UT SPOT TRACK Ø86 WALL-WASHER
- 3 UT DOWNLIGHT Ø86
- 4 UT PRO SURFACE 150

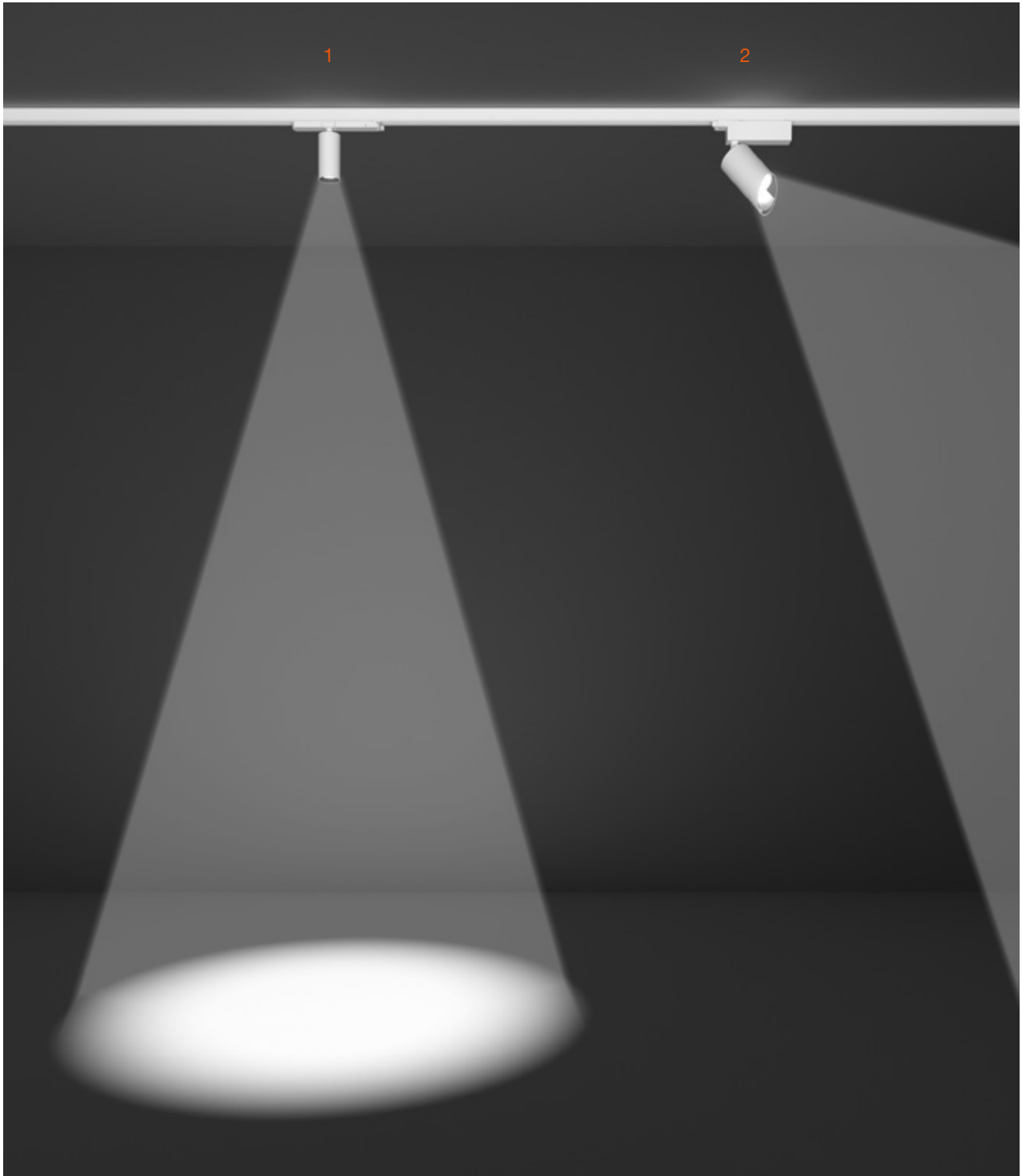

Programme professionnel complet, idéal pour le contrôle de toute application en magasin. Le kit élargi d'optiques, les puissances et la polyvalence qui caractérisent chaque modèle, font de la gamme UT la solution parfaite pour toute exigence technique dans un espace d'exposition.

Complete professional program, ideal for controlling any retail application. The extended optics kit, powers and versatility that characterize each model make the UT range the perfect solution for any technical requirement of display areas.

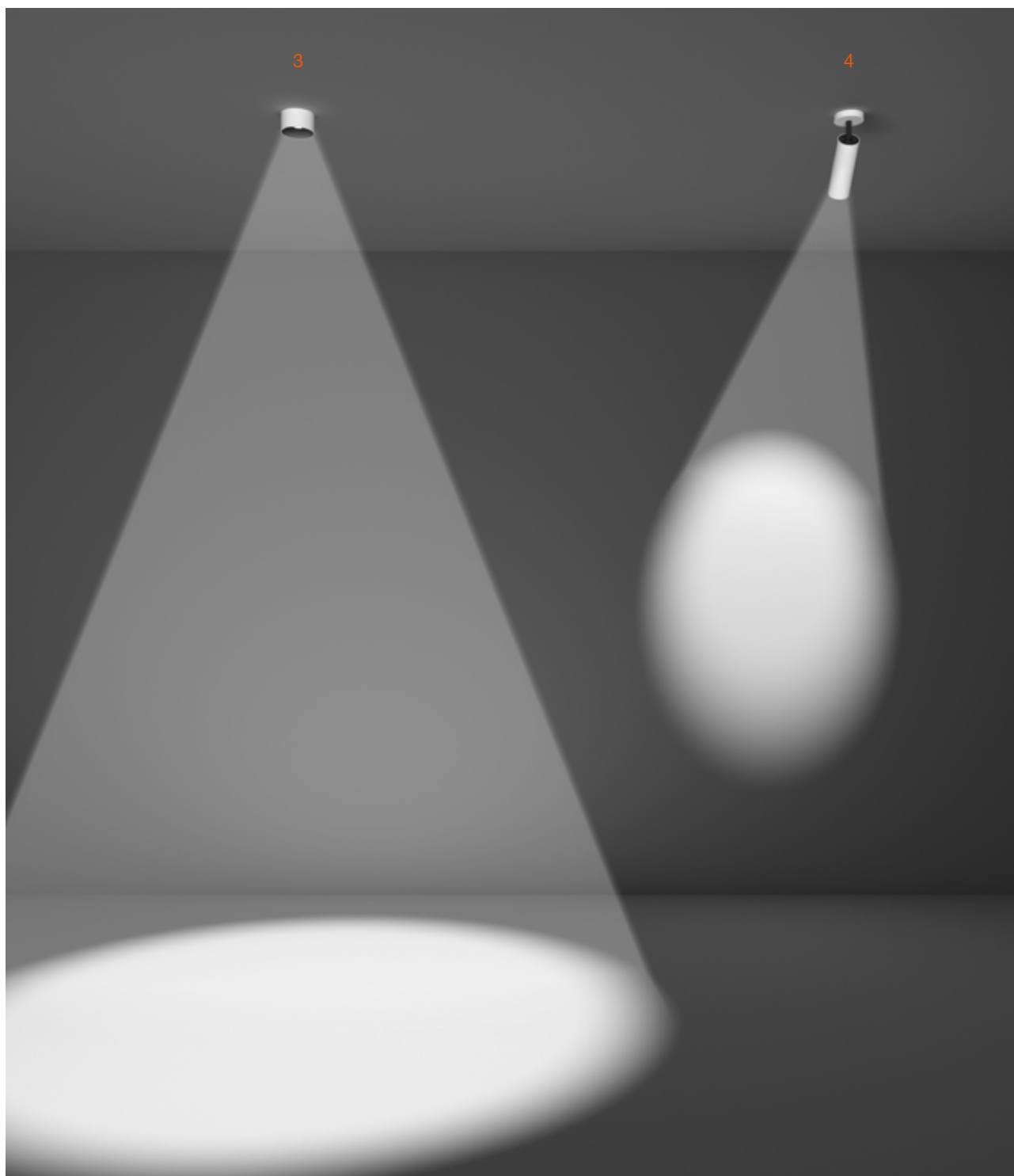



De Witte Duif,
Belgium

Système de réglage à l'aide d'un guide cranté qui permet de dissimuler les projecteurs qui s'intègrent ainsi dans l'environnement.

An adjustment system on a toothed guide permits concealing the spotlights, thus becoming integrated into the environment.

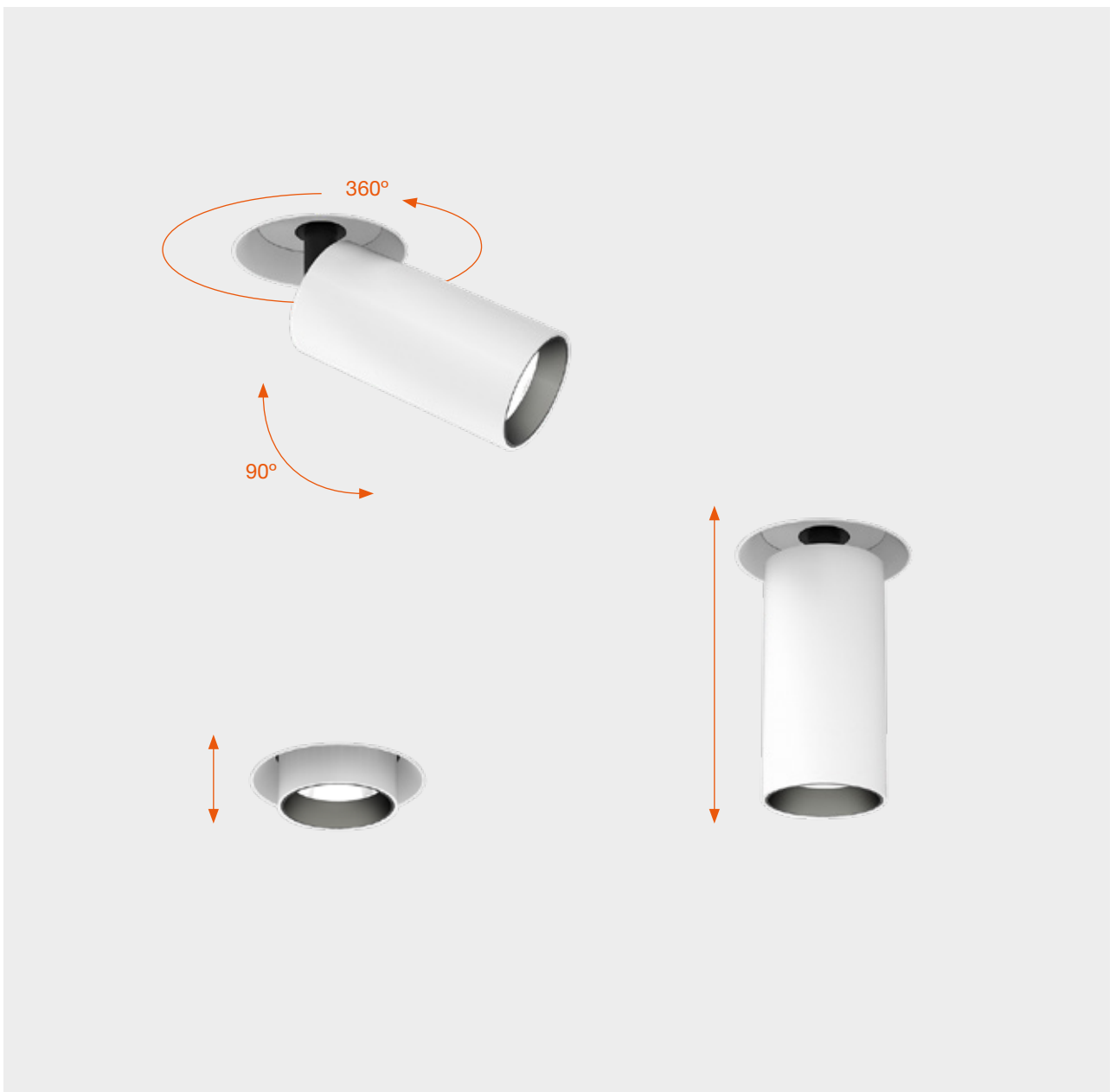





TRACK
Ø57

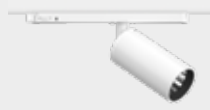

LED ARRAY
23,5W

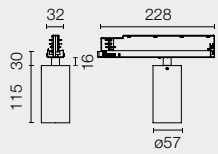

Dali Version

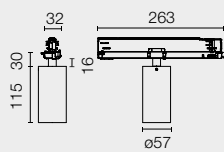

TRACK
Ø57



LED ARRAY
23,5W

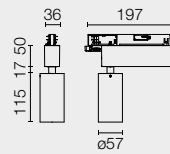

Dali Version

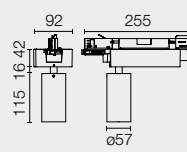

CEILING
Ø57



LED ARRAY
23,5W

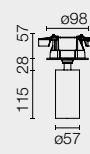

Super Spot



Spot



Medium



Flood

□ 30 Blanc
30 White

■ 14 Noir
14 Black

□ 30.78 All White
30.78 All White

□ 30 Blanc
30 White

■ 14 Noir
14 Black



Peut être pivoté à 360° et orienté à 90°.
Can be rotated 360° and swivelled 90°.

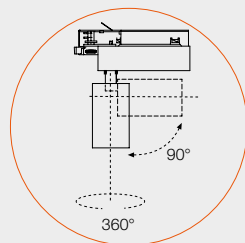

TRACK
Ø86

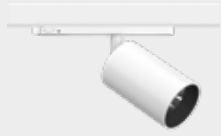

**LED ARRAY
HIGH PERFORMANCES
33W
PHOSPHOR LED
27W**

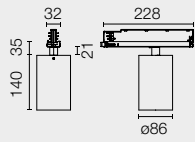

Dali Version

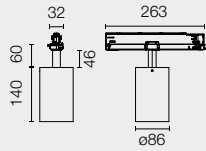

TRACK
WALL-WASHER
Ø86

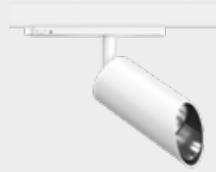

**LED ARRAY
HIGH PERFORMANCES
33W**

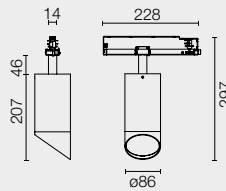

Dali Version

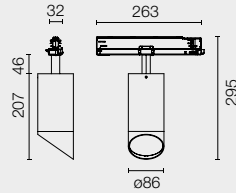

CEILING
Ø86



**LED ARRAY
HIGH PERFORMANCES
33W
PHOSPHOR LED
31W / 34W**

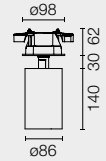

TRACK
Ø86



**PHOSPHOR LED
31W / 34W**

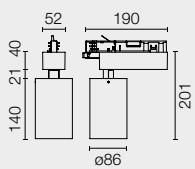

**LED ARRAY
HIGH PERFORMANCES
33W**

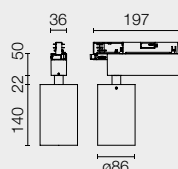

Dali Version

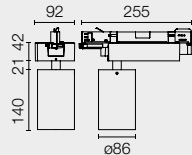

TRACK
WALL-WASHER
Ø86



**LED ARRAY
HIGH PERFORMANCES
33W**

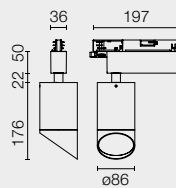

TRACK
MULTICHIP
Ø86

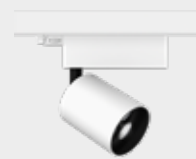

**TOP LED
11,5W**

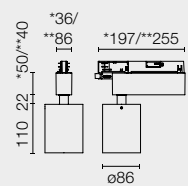

*Dimable/Non Dimable
**Dali Version

RECESSED

SURFACE

TRIM / NO TRIM
Ø57



LED ARRAY
18W

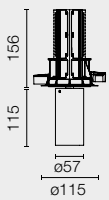
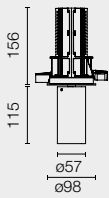

TRIM / NO TRIM
Ø86



LED ARRAY
HIGH PERFORMANCES
27W

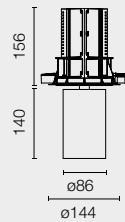
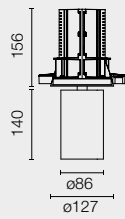

UT PRO SURFACE
150



LED ARRAY
21W

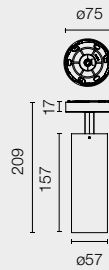

UT PRO SURFACE
175



LED ARRAY
35,3W

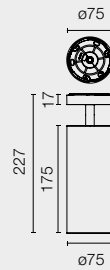

Peut être pivoté à 360° et orienté à 90°.
Can be rotated 360° and swivelled 90°.

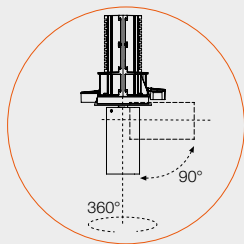

Spot



Medium



Flood

□ 30 Blanc
30 White



■ 14 Noir
14 Black



□ 30 Blanc
30 White



■ 14 Noir
14 Black



UT PRO 150
GA-69



LED ARRAY
23,5W

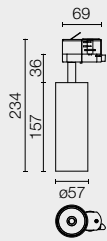

UT PRO 175
GA-69



LED ARRAY
35,3W

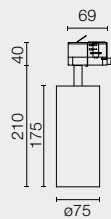

UT PRO 175 LENS
GA-69



LED ARRAY
35,3W

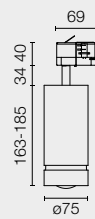

UT PRO WALL-WASHER
GA-69



TOP LED
25,5W

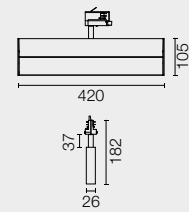

Compatible avec The Tracking Power.
Compatible with The Tracking Power.



Spot



Medium



Flood



Wall-Washer

BON

BON JOUR

BON JOUR BON JOUR

BON JOUR BON JOUR

BON JOUR

BON JOUR BON JOUR

BON JOUR BON JOUR

JOUR

Encastrés LED au design original grâce à la petite bordure qui signale la présence du luminaire. Disponible en trois dimensions, avec différentes optiques pour une plus grande personnalisation. Des lignes pures accentuées par des finitions raffinées, dans des versions neutres et métallisées.

Recessed LED with an unusual design, thanks to the small edge that defines the presence of the luminaire. Comes in three sizes with different optics for a better personalisation. Pure lines highlighted with the refined finishes, in neutral and metal plated versions.

BON JOUR

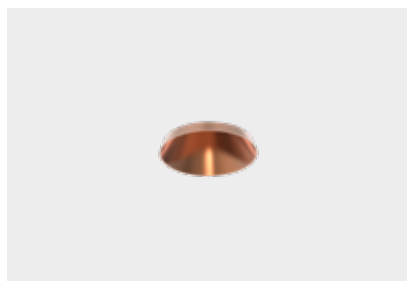
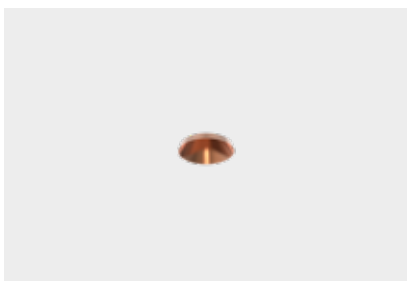

Bon Jour exploite un récupérateur de lumière conique emblématique, visible après installation et distingué par une géométrie interne exclusive lui permettant d'éliminer complètement l'éblouissement visuel tout en fournissant un merveilleux éclairage diffus.

Bon Jour exploits an iconic conical light retriever visible after the installation. It is characterized by a unique internal geometry allowing it to completely eliminate visual glare and providing beautiful diffuse lighting at the same time.

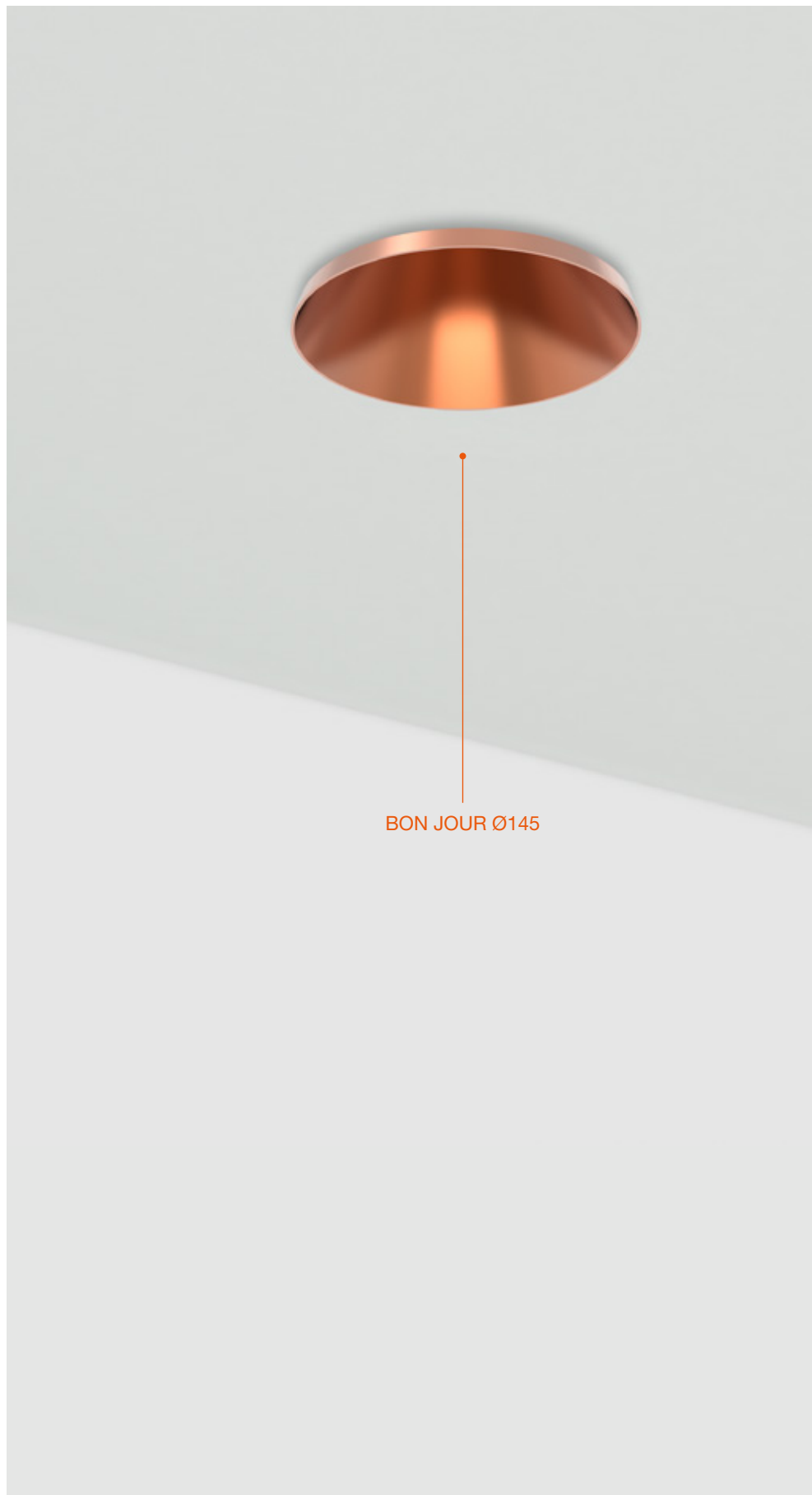

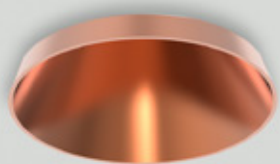

BON JOUR Ø90

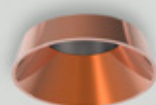

BON JOUR Ø45

Produit unique dans sa catégorie, Bon Jour réinterprète le concept de downlight grâce à un design unique associé à des matériaux et des finitions de la plus haute qualité.

A unique product in its category, Bon Jour reinterprets the concept of downlighting through a remarkable design combined with the highest quality materials and finishes.

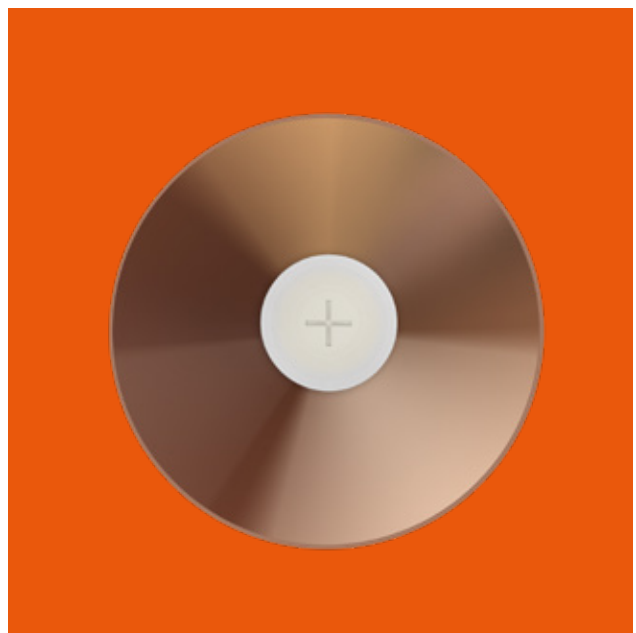
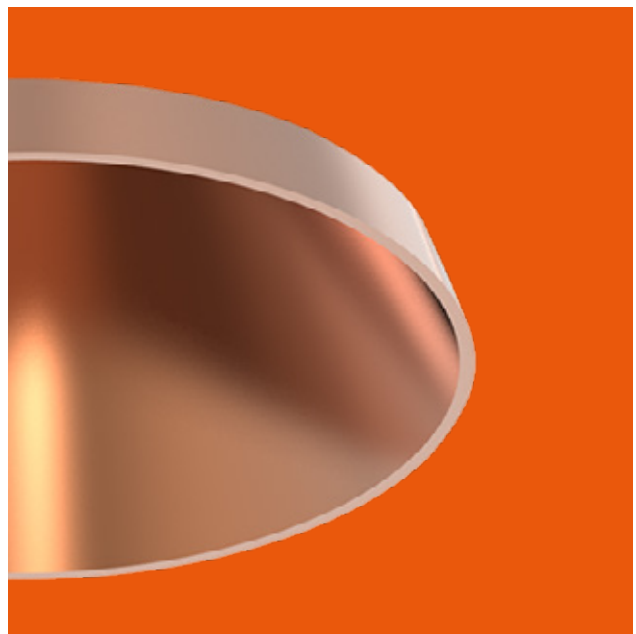





BON JOUR
Ø45



POWER LED
6W



BON JOUR
Ø90



LED ARRAY
13,5W

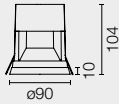

BON JOUR
Ø145

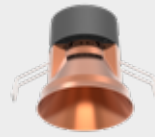

LED ARRAY
36W

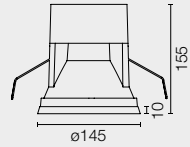

□ 01 Blanc
01 White



■ CU Cuivre
CU Copper



■ 14 Noir
14 Black



FLOS
CONTROL BY CASAMBI



XONY FORT FORT

XONY FORT FORT

XONY FORT FORT

FORT KNOX

FORT KNOX

FORT KNOX

FORT KNOX

FORT KNOX

FORT KNOX

Fort Knox Wall est un luminaire avec une structure épaisse produisant un faisceau lumineux indirect très puissant. Il s'adapte parfaitement dans les foyers à des plafonds proéminents en les utilisant comme diffuseur naturel.

Fort Knox Wall is a luminaire with coarse structure that produces an indirect and very powerful light beam, perfect for homes with protruding ceilings, working as natural diffuser.

FORT KNOX



FORT KNOX WALL

Incroyablement compact et discret, Fort Knox Wall distingue l'environnement par une lumière indirecte extrêmement contrôlée et homogène.

Incredibly compact and discreet, Fort Knox Wall characterizes the environment with extremely controlled and homogeneous indirect light.

Niveau intégré pour faciliter l'installation.

Lentille exclusive à haute efficacité qui permet d'orienter le faisceau de lumière vers le haut.

Level for easy, integrated installation.

Highly efficient lens which directs the beam of light upwards.

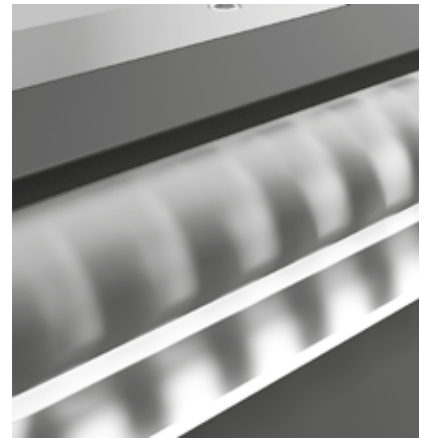

FORT KNOX WALL MINI

La forte asymétrie de l'effet permet de gérer facilement les espaces les plus complexes, même dans la nouvelle version miniaturisée Fort Knox Wall Mini.

The strong asymmetry of the effect eases the management of the most complex spaces even in the new miniaturized version Fort Knox Wall Mini.







Sensory Apartment
Palazzo Poste, Italy



FORT KNOX
WALL



POWER LED
35W

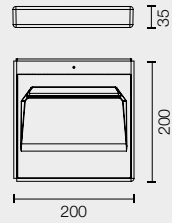

FORT KNOX
WALL MINI



POWER LED
25W

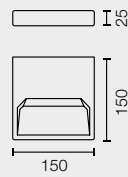

Asymmetric
Flood

□ 40, 30 Blanc
40, 30 White



◻ 05 Aluminium Poli
05 Polished Aluminium



■ 14 Noir/RAL 9005
14 Black



Led Curtain, In-Finity, Circle of Light, Light Cut
Mini, Super Flat, Light Bell, Thin Led, Light
Supply, Johnny, Wan Spot, Wan Downlight, G-O,
The BlockOfLight

SOPHISTICATED COMMODITIES

LED CURTAIN

Designed by Flos Architectural

Luminaire à encastrer équipé d'une source de lumière LED. Spécialement conçu pour un éclairage wall-washer, le Led Curtain est doté de verres elliptiques pour une parfaite diffusion de la lumière. La famille Led Curtain compte différentes longueurs interconnectables entre elles, ce qui fait qu'elle s'adapte facilement aux différents espaces, et de par ses dimensions réduites, elle s'intègre facilement dans l'architecture.

Family of circular ceiling-mounted recessed luminaires, which are totally integrated owing to Soft Architecture technology. The Circle of Light is comprised of an outer frame made with composite that houses a metal structure. This, in turn, acts as support for the latest generation LED spotlights. Its lenses optimise the luminous performance of the luminaire together with anti-glare cones that guarantee high visual comfort.

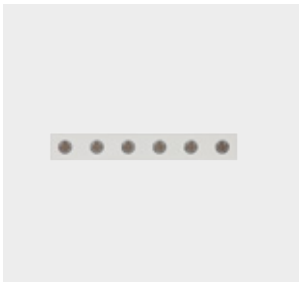

Find out more at
flos.com/ledcurtain

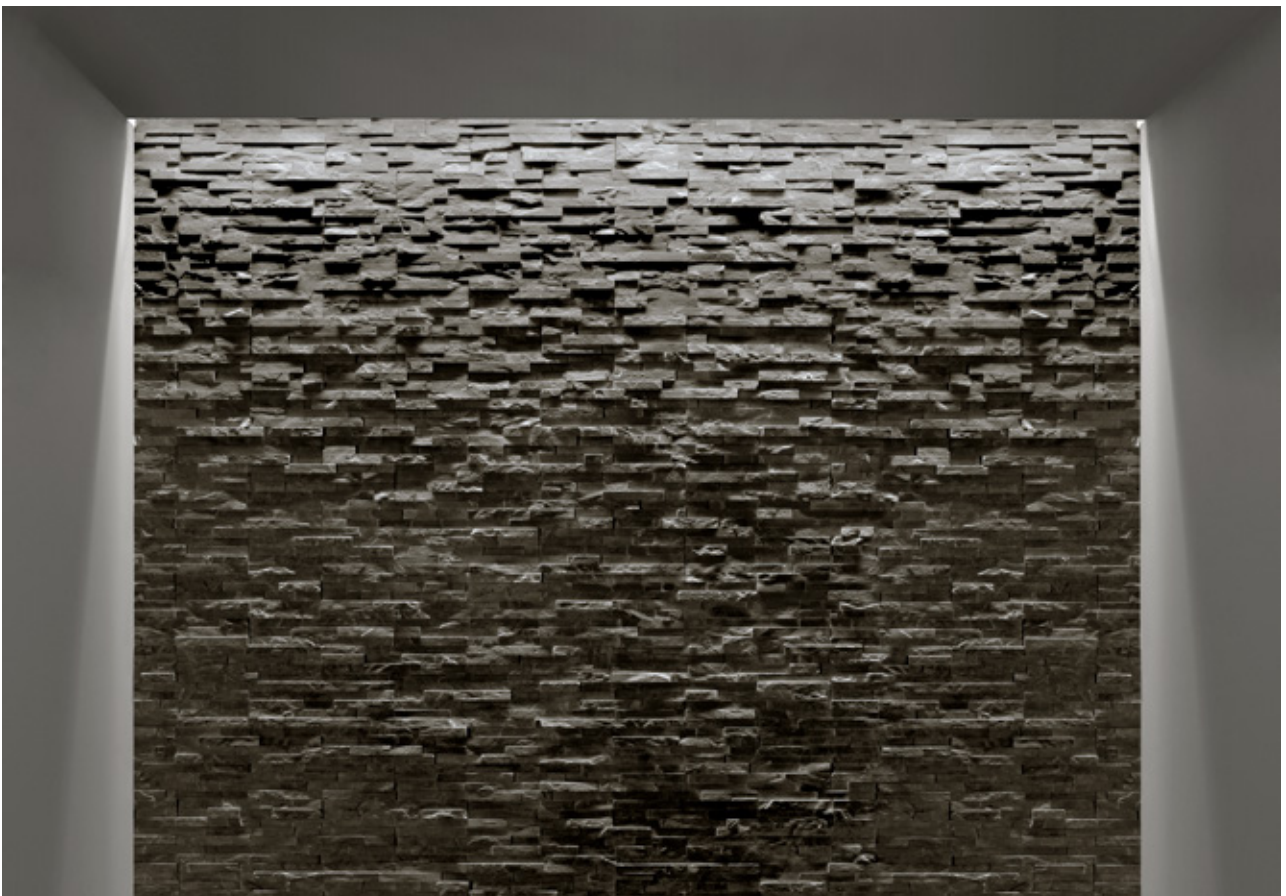



Cosín Showroom, Spain

IN-FINITY

Designed by Flos Architectural

Pour les professionnels de l'éclairage à la recherche d'un éclairage principal pour les bureaux ou les espaces publics, In-Finity est un système d'éclairage LED qui offre des solutions adaptées à tous les types d'installation, avec des luminaires conçus pour être utilisés en point lumineux seul ou en ligne continue de lumière. In-Finity non seulement fournit un confort visuel efficace, mais associe également les meilleures performances esthétiques et d'excellentes qualités de fabrication. Toutes les exigences d'un projet peuvent être satisfaites en combinant les trois largeurs de profilé et les quatre possibilités d'installation (encastré trim, et no trim, en surface et en suspension) avec les versions d'éclairage à lumière diffuse ou concentrée, en fonction du cahier des charges.

For lighting professionals looking for the backbone of a lighting installation for an office or public space project, the In-Finity LED lighting system offers coherent solutions suitable for any kind of installation, with luminaires designed for use as a single light source or arranged in an infinite light line. In-Finity delivers visual comfort and energy efficiency, combining high performance with impeccable aesthetics and top quality construction. All project needs can be satisfied with combinations of the three profile widths, the various installation options (recessed trim and no trim, surface-mounted and suspended) and diffuse or concentrated glare-free light versions to meet ambient design requirements.

Profil modulaire pour installation encastrée. Disponible en trois sections différentes (35 et 70 mm), il peut s'adapter à tout environnement architectural grâce à son esthétique sobre et purement technique. L'émission lumineuse du profil peut être personnalisée grâce aux écrans disponibles en option pour une lumière diffuse et contrôlée.

Modular profile for recessed installation. Available in three different sections (35 and 70 mm). It can be adapted to any architectural environment thanks to its subtle and purely technical aesthetics. The profile's lighting emission can be customized thanks to the optional screens available for both diffuse and controlled light.



Find out more at
flos.com/infinity35



Find out more at
flos.com/infinity70

RECESSED



Porcelanosa Showroom,
Spain



Fantini Showroom, Italy



Gomarco Headquarters,
Spain

Profilé modulaire pour installation au plafond et au mur. Disponible en trois sections différentes (25, 35 et 70 mm), il peut s'adapter à tout environnement architectural grâce à son esthétique sobre et purement technique. L'émission lumineuse du profil peut être personnalisée grâce aux écrans disponibles en option pour une lumière diffuse et contrôlée.

Modular profile for ceiling and wall installation. Available in three different sections (25, 35 and 70 mm). It can be adapted to any architectural environment thanks to its subtle and purely technical aesthetics. The profile's lighting emission can be customized thanks to the optional screens available for both diffuse and controlled light.

SURFACE

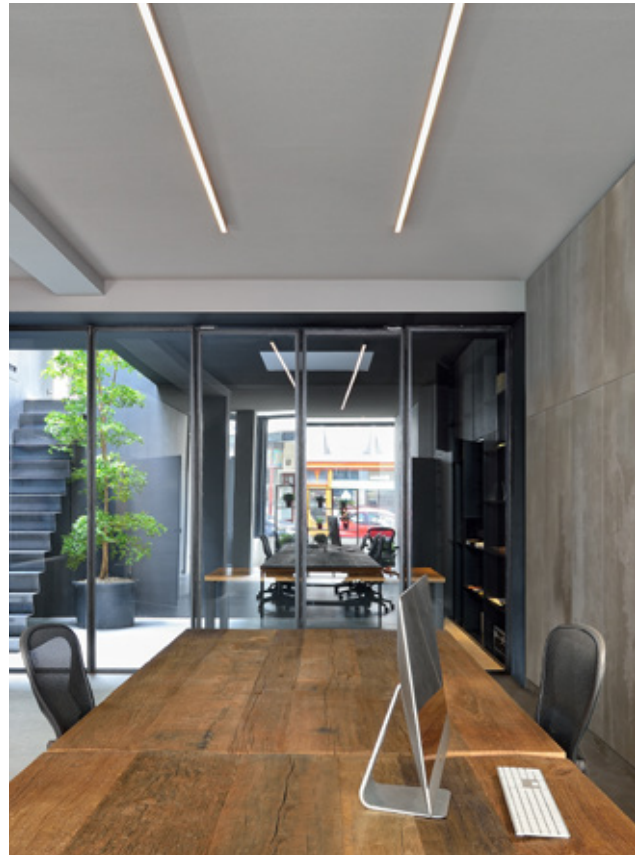
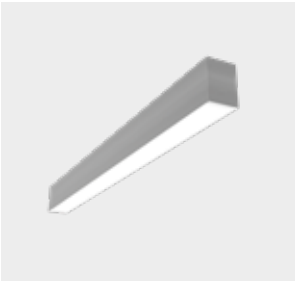

Profilé modulaire pour installation en suspension. Disponible en trois sections différentes (25, 35 et 70 mm), il peut s'adapter à tout environnement architectural grâce à son esthétique sobre et purement technique. L'émission lumineuse du profil peut être personnalisée grâce aux écrans disponibles en option pour une lumière diffuse et contrôlée.

Modular profile for suspension installation. Available in three different sections (25, 35 and 70 mm). It can be adapted to any architectural environment thanks to its subtle and purely technical aesthetics. The profile's lighting emission can be customized thanks to the optional screens available for both diffuse and controlled light.

SUSPENSION

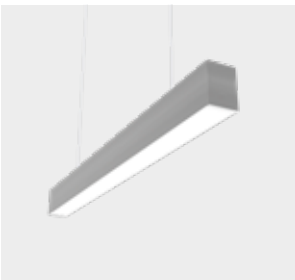



CIRCLE OF LIGHT

Designed by Flos Architectural

Famille de luminaires circulaires à encastrer au plafond, s'intégrant totalement grâce à la technologie Soft Architecture. Le Black Circle est composé d'un cadre extérieur en composite sur lequel vient se loger une structure métallique servant de support aux projecteurs LED de dernière génération. Il possède des verres optimisant l'efficacité lumineuse du luminaire avec des cônes anti-éblouissement offrant un grand confort visuel.

Family of circular ceiling-mounted recessed luminaires, which are totally integrated owing to Soft Architecture technology. The Circle of Light is comprised of an outer frame made with composite that houses a metal structure. This, in turn, acts as support for the latest generation LED spotlights. Its lenses optimise the luminous performance of the luminaire together with anti-glare cones that guarantee high visual comfort.

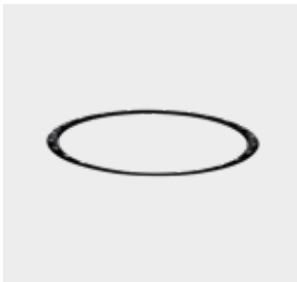

Find out more at
flos.com/circleoflight

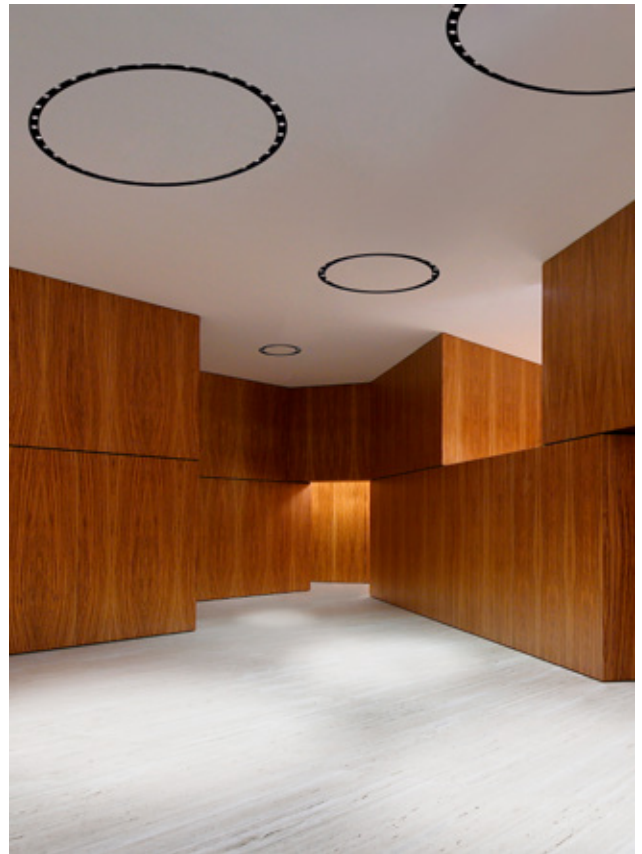

Private Hall Entrance,
Spain

LIGHT CUT MINI

Designed by Flos Architectural

Système structurel intégré dans l'architecture qui permet d'installer aussi bien des appareils à éclairage direct que des appareils à éclairage indirect. Le système Light Cut Mini peut être équipé de projecteurs LED de dernière génération, de projecteurs halogènes ou à halogénure métallique. L'éclairage environnemental est disponible en fluorescence, en LED et LED RGB.

A structural system integrated into the architecture, which permits mounting direct and indirect lighting gear. The Light Cut Mini system can be equipped with latest generation LED spotlights, halogen spotlights or metal halide spotlights. The ambient lighting is available in fluorescent, LED and in RGB LED lamps.

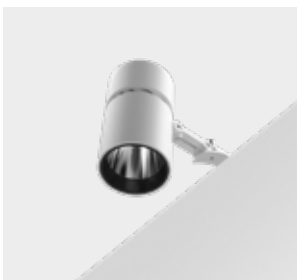

Find out more at
flos.com/lightcutmini

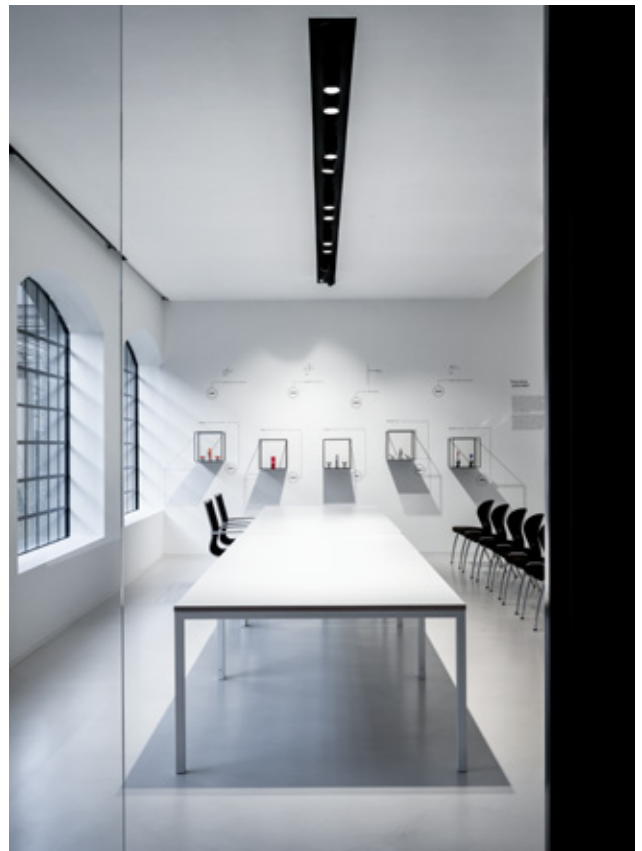

Fantini Showroom, Italy

SUPER FLAT

Designed by Flos Architectural

Famille de luminaires d'éclairage général (d'un impact minimal grâce à son profil réduit) à éclairage direct et indirect. Équipée de sources d'éclairage LED diffusant un flux lumineux optimal et d'un grand confort visuel, ce qui permet de minimiser les pertes d'énergie.

Family of general lighting luminaires (minimal visual impact thanks to their reduced profile) with direct and indirect light distribution. Equipped with LED lighting sources that supply an optimal flow of light, great visual comfort and minimising energy losses.

SUSPENSION



Find out more at
flos.com/superflat

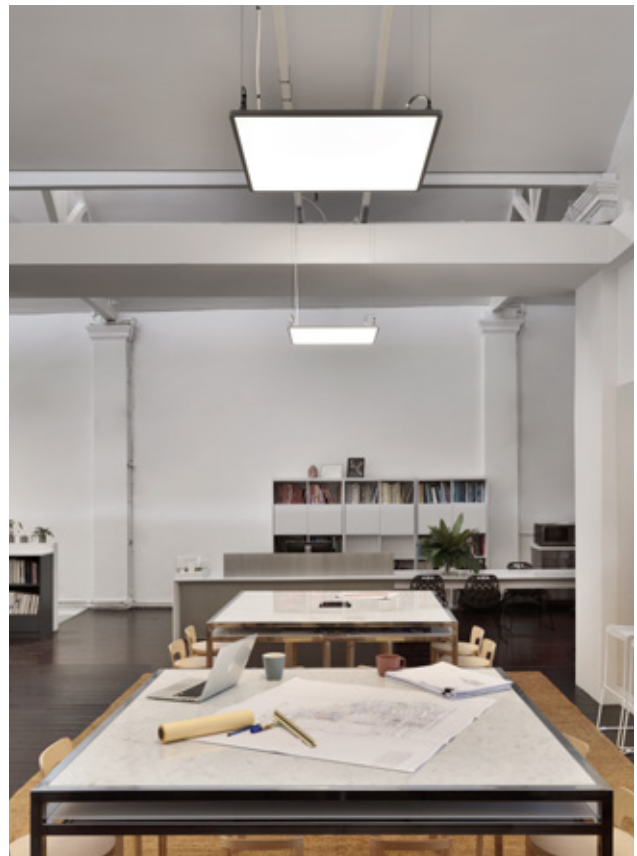

Offices, Singapur

SURFACE



Defant's Club Gym, Italy

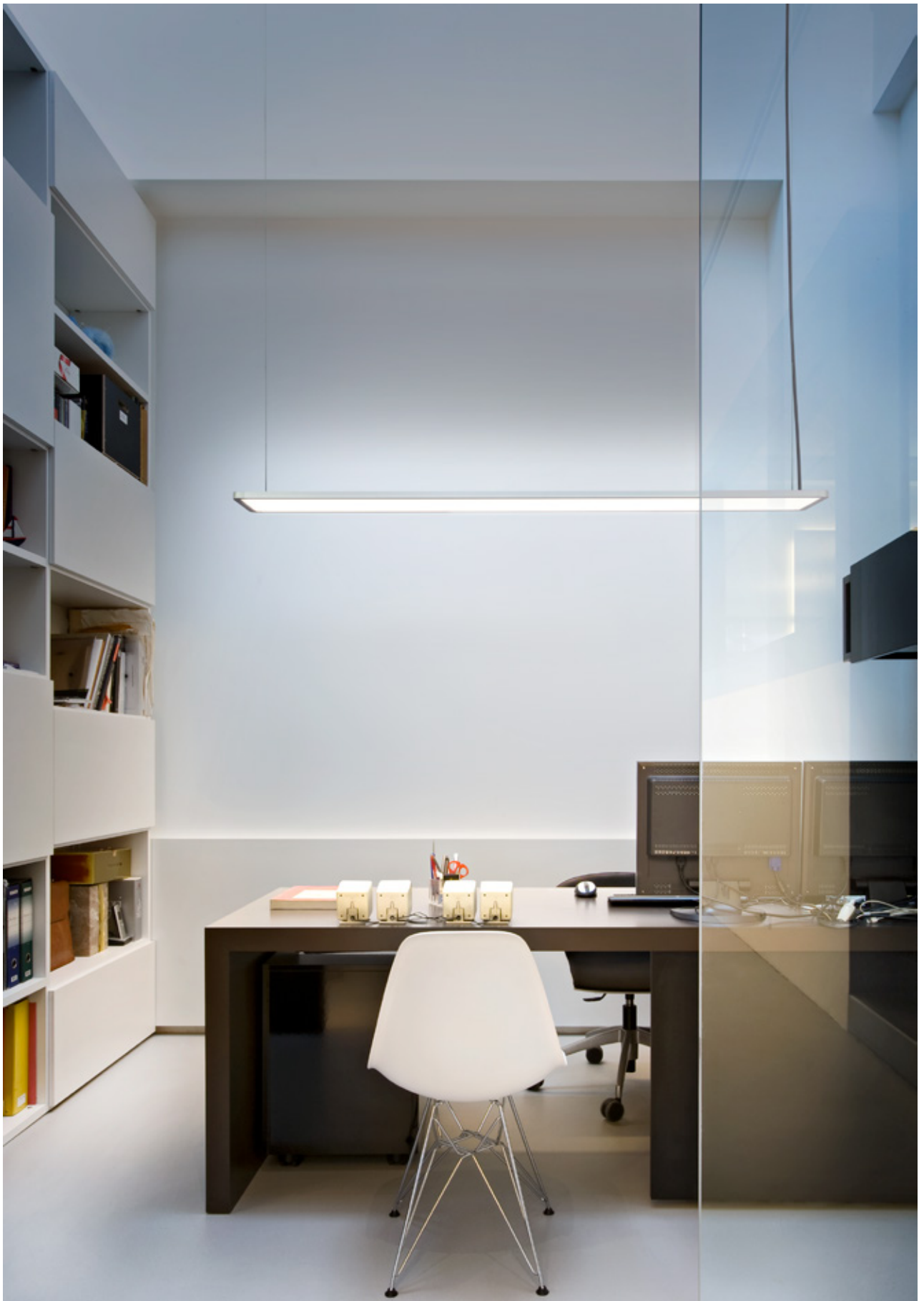



LIGHT BELL

Designed by Piero Lissoni

Luminaire suspendu d'éclairage général pour intérieurs. Avec source de lumière LED de dernière génération à haute efficacité et diffuseur thermoplastique technique à faibles pertes. Le réflecteur du luminaire est en aluminium repoussé, disponible en divers finitions, à l'intérieur ainsi que à l'extérieur et en verre transparent.

Suspended general lighting luminaire for indoor mounting. It has a high efficiency, latest generation LED light source and a low-loss technical thermoplastic diffuser. The luminaire reflector is made of spun aluminium, available in different patterns inside as well as outside and in transparent glass.



Find out more at
flos.com/lightbell





THIN LED

Designed by Flos Architectural

Profil mural pour éclairage indirect. Essentiel et minimal pour une parfaite intégration dans l'espace architectural environnant. Aux dimensions réduites mais à haut rendement lumineux. Un appareil unique pour un éclairage asymétrique parfaitement uniforme.

Wall-mounted profile for indirect lighting. Essential and minimal for perfect integration into the surrounding architectural space. Thin, but with really high lighting performances. A unique device for even and spotless asymmetrical lighting.



Find out more at
flos.com/thinled





LIGHT SUPPLY

Designed by Flos Architectural

Encastré à forte puissance avec modules LED de dernière génération. Dimensions compactes pour une parfaite intégration dans l'architecture. Disponible en versions fixe, wall-washer et réglable, avec accessoires professionnels de blindage.

High-power recessed elements with avant-garde LED modules. Compact size with maximum integration into the architecture. Comes in fixed, wall-washer and adjustable versions, with professional screening accessories.



Find out more at
flos.com/lightsupply

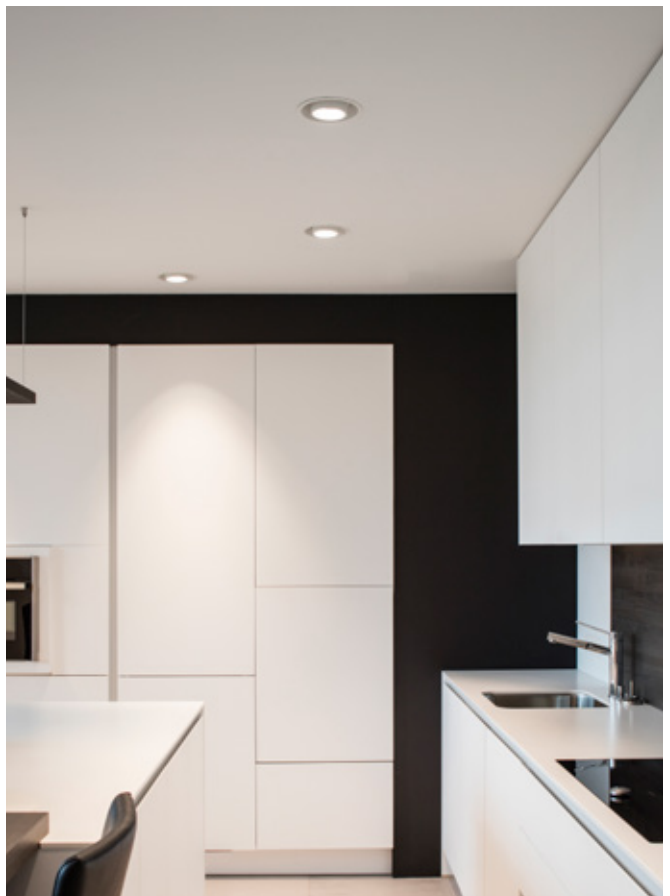

Sublime Store, Belgium

JOHNNY

Designed by Flos Architectural



Find out more at
flos.com/johnny

Projecteur polyvalent grâce aux deux tailles disponibles et à la grande variété d'installations possibles. Intégration maximale de la version encastrée, ou forte présence esthétique des versions semi encastrées avec des finitions dans des matériaux uniques. Equipé d'un système mécanique de rotation qui garantit son efficacité, son intégration et sa stabilité dans le temps. Egalement versions pour installation rapide sans cadre avec le système Fast&Perfect.

Versatile projector thanks to the two available sizes and the great variety of installation possibilities. Possibility of maximum integration in the recessed version, or of a stronger aesthetic presence in the semi-recessed versions with exclusive finishes. Fitted with a mechanical rotation system that ensures efficiency, integration and stability over time. Includes different versions for a fast frame-free installation with the Fast&Perfect system.



ROUND 80 RECESSED



ROUND 120 RECESSED

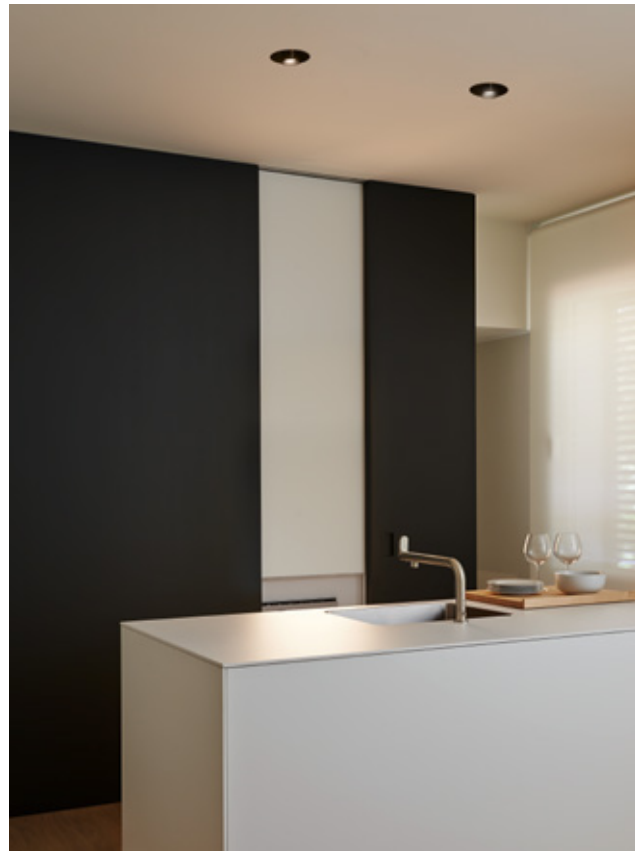

Johnny 80 / Johnny 80 Semi-encasté : système d'orientation basculant qui permet de retirer la tête du projecteur pour un meilleur réglage.

Johnny 80 / Johnny 80 Semi-recessed: with the tilt orientation system the spotlight head can be pulled and tilted in the desired direction.

Box semi encastré. Disponible en finitions béton, teck, blanc ou noir selon les versions.

Box for semi-embedded installation. Available with cement, teak, white or black finishes, according to the versions.

SQUARE 80 RECESSED



SQUARE 80 SEMI-RECESSED



Johnny 120 / Johnny 120 Semi-encasté: système d'orientation mécanique qui permet de retirer la tête du projecteur pour un meilleur réglage.

Johnny 120 / Johnny 120 Semi-recessed: a mechanic orientation system that enables pulling the head out of the projector for a correct orientation.

Box semi encastré. Disponible en finitions béton, teck, blanc ou noir selon les versions.

Box for semi-embedded installation. Available with cement, teak, white or black finishes, according to the versions.

SQUARE 120 RECESSED



SQUARE 120 SEMI-RECESSED

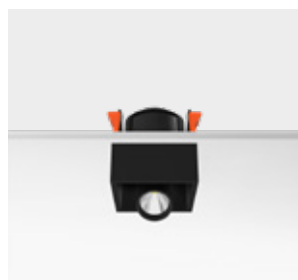



WAN

Designed by Johanna Grawunder

Famille d'appareils d'éclairage dont la forme est inspirée de la culture japonaise: "wan" signifie bol, dans sa fonction de "contenant de la vie". Deux versions : une version spot, équipée d'un système spécial d'orientation du faisceau lumineux, et une version à encastrer. Disponibles avec lampes halogènes ou à halogénures métalliques pour s'adapter aux diverses situations qu'il s'agisse d'un environnement résidentiel ou professionnel. Également disponibles avec les nouvelles lampes LED.

Family of lighting devices whose shape is inspired by the Japanese culture: in fact, "wan" means "cup" but in a figurative sense it is understood as a "life container". Two versions: one spot, equipped with a special beam directional system and a second one for recessed systems. Available with halogen or metal halide lamps to adapt to different situations, either in residential or professional sectors. Also available with the new LED lamp.



SPOT

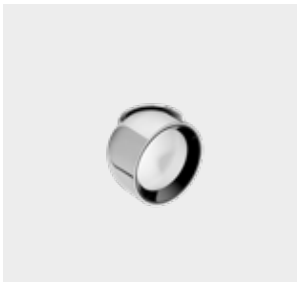

Find out more at flos.com/wanspot



Private House, Italy

DOWNLIGHT



Find out more at flos.com/wandownlight



Private House, U.K.

G-O

Designed by Jorge Herrera

Luminaire à encastrer avec un niveau de protection IP65 pour intérieur/extérieur. Equipé d'une LED de dernière génération, G-O est spécialement conçu pour le balisage de chemins ou d'escaliers. Disponible en finitions blanc, aluminium, acier inoxydable, bronze et noir. Le système optique peut émettre une lumière blanche chaude ou ambré grâce aux diffuseurs colorés qui sont à l'intérieur.

Recessed luminaire with IP65 protection degree for indoors/outdoors use. Equipped with latest generation LED, G-O is especially designed as bollard lighting for pathways or steps. It is available in white, aluminium, stainless steel, bronze and black finishes. The optical equipment can transmit warm white or amber light thanks to the coloured diffusers on the inside.

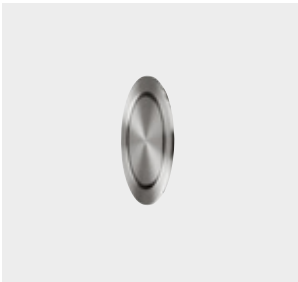

Find out more at flos.com/go

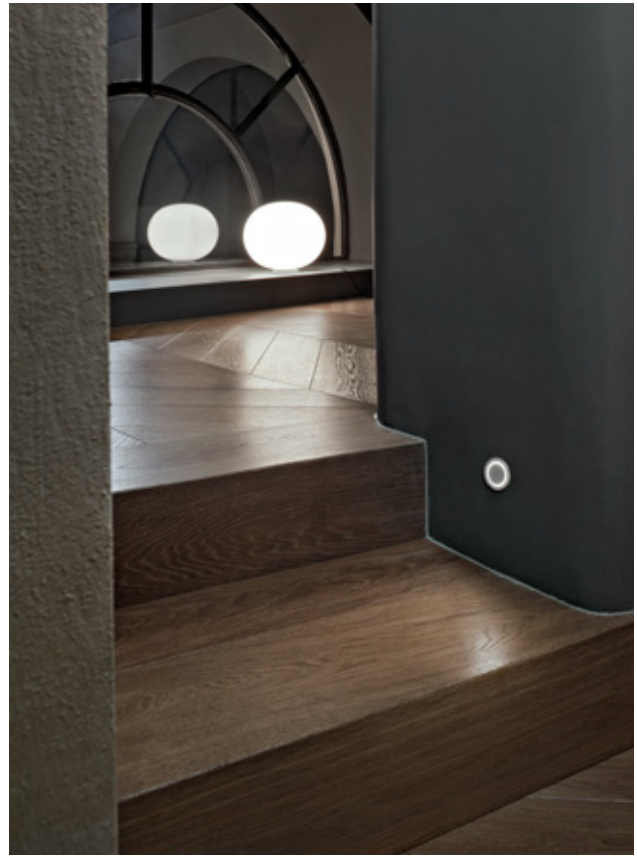

Montenapoleone Vip Lounge, Italy

THEBLOCKOFLIGHT

Designed by Knud Holscher

Luminaire de balisage à encastrer. Idéal pour intérieurs/ extérieurs grâce à son niveau de protection IP65. TheBlockofLight est équipé d'une Power LED de dernière génération et d'un diffuseur opale favorisant une répartition optimale de la lumière.

Recessed signage luminaire. Perfect for indoors/outdoors thanks to its IP65 protection degree. TheBlockofLight has a latest generation Power LED and an opal diffuser for optimal light distribution.



Find out more at flos.com/theblockoflight

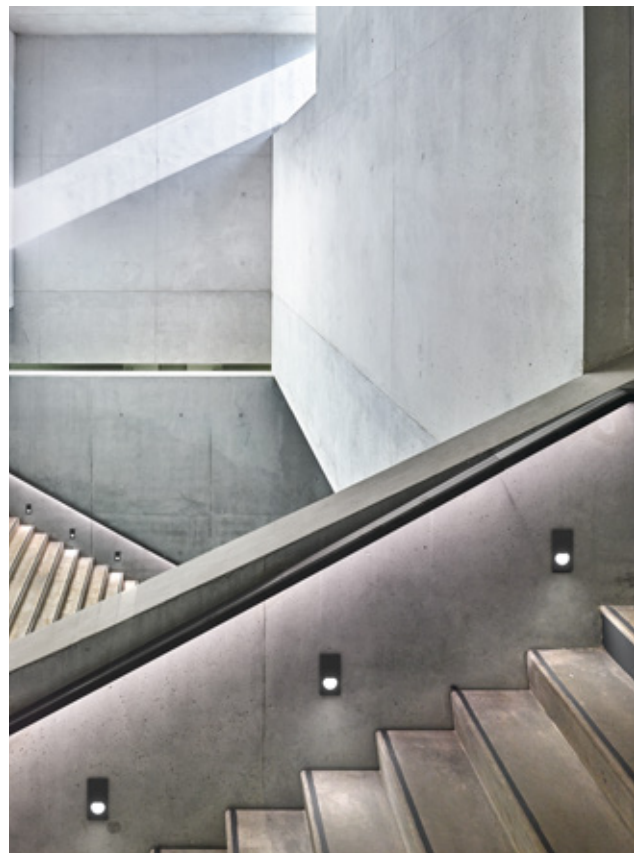

Music Conservatory, Spain



Wall Rupture, Softprofile, Juncos,
Soft Spun, Abajourd'hui, Uso, Uso
Cove Lighting, G-O In, Teardrop,
Round, Square & Vertical Light.

SOFT ARCHITECTURE



UNE FUSION NATURELLE ENTRE LA SUBSTANCE ET L'ÉNERGIE, ENTRE LA LUMIÈRE ET L'ARCHITECTURE
 A NATURAL FUSION OF SUBSTANCE AND ENERGY, BETWEEN LIGHT AND ARCHITECTURE

Aimer la lumière et l'architecture, les mêler aux solutions les plus créatives, en visant les objectifs les plus avancés sur le plan technique et lumineux, dans un total respect de l'environnement : Flos Soft-Architecture est la nouvelle philosophie pour vivre de manière poétique la fusion entre la matière et l'énergie.

Loving light and architecture, melting them in the most creative solutions, looking for the most advanced, lighting and technical aims and fully respecting the environment: Flos Soft-Architecture is the new philosophy to live poetically the fusion of substance and energy.

Respecter la nature et son équilibre en comprendre sa valeur et être inspiré par sa perfection : Flos Soft-Architecture est le fruit d'une recherche approfondie sur l'utilisation de matériaux éco-compatibles à faible impact environnemental.

Respecting nature and its balance understanding its value and being inspired by its perfection: Flos Soft-Architecture is the result of an in-depth lighting and technical research on the use of eco-friendly materials with a low impact on the environment.

Union parfaite de matière et d'énergie, Flos Soft-Architecture utilise les sources économie d'énergie les plus avancées (LED, LED au Phosphore déporté, Power LED, cathode froide, fluo-compacte, halogène, IRC/ES) afin de garantir une synthèse parfaite entre la lumière, l'architecture et la nature.

Flos Soft-Architecture is a perfect fusion of substance and energy and benefits of the most advanced energy saving sources (LED, Remote Phosphor LED, Power LED, cold cathode, compact fluorescent, halogens, IRC/ES) in order to grant a perfect integration of light, architecture and nature.



1 "Respecter la Nature et son Équilibre".
 "Respecting Nature and its Balance".

2 Fabrication de Soft Architecture.
 Soft Architecture Manufacturing.

3 Cycle de Vie Durable.
 Sustainable Lifecycle.

4 Réutilisation sans Impact Environnemental.
 Relocation with no Environmental Impact.

5 Vente et Installation.
 Sale and Installation.



Dans l'usine Flos Architectural, les techniques traditionnelles et les formules pionnières se mélangent pour créer des produits qui n'ont encore jamais existé. En utilisant des matériaux composites innovants, Soft Architecture, notre gamme de solutions d'éclairage intégré, prend naissance entre les mains d'artisans locaux qualifiés. Flos Soft Architecture est un bel exemple de fabrication contemporaine, sans déchets, modelée par les mêmes processus que ceux de la nature.

In the Flos Architectural factory, traditional techniques and pioneering formulas blend together to create products that have never before existed. Making use of an innovative plaster composition, our Soft Architecture series of seamless lighting appliances comes to life through the hands of skilled local artisans. Flos Soft Architecture is a great example of contemporary, waste-free manufacturing, modelled by nature's very own processes.





WALL RUPTURE

Designed by Thierry Dreyfus

Wall Rupture est un luminaire réalisé en Soft Composite. L'effet est semblable à celui d'un pli secret sur le mur qui occulte le relief irrégulier de la terre. Disponible en couleurs or et argent. Comprend des bandes de LED à différentes températures de couleurs : 2700K (version décoration or) ou 5000K (version décoration argent).

Wall Rupture is an invisible luminaire made of Soft Composite. The effect is like a secret fold in the wall that conceals the irregular relief of the earth. Available in gold and silver. It incorporates LED strips with different colour temperatures: 2700K (gold version) or 5000K (silver version).



Find out more at
flos.com/wallrupture



Expo Valle d'Aosta, Milan



Starhotels E.c.h.o. Hotel,
Italy



SOFTPROFILE SMOOTH

Designed by Flos Soft Architecture

Grâce à la technologie Soft Composite, les produits s'intègrent parfaitement dans l'espace architectural. Il existe trois versions: la version Smooth au profil lisse, la version Starck au profil inspiré de la lampe Long & Hard, et la version Wanders au profil inspiré de la lampe Sky Gardens. Les trois versions peuvent être installées au plafond ou au mur.

Thanks to the Soft Composite technology the profiles become perfectly integrated into the architectural space. There are three versions: the Smooth version characterised by its plain profile, the Starck version whose profile is inspired by the Long & Hard lamp, and the Wanders version with profile inspired by the Sky Garden lamp. All three versions can be ceiling and wall mounted.

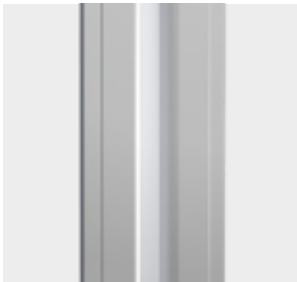

Find out more at
flos.com/softprofilessmooth

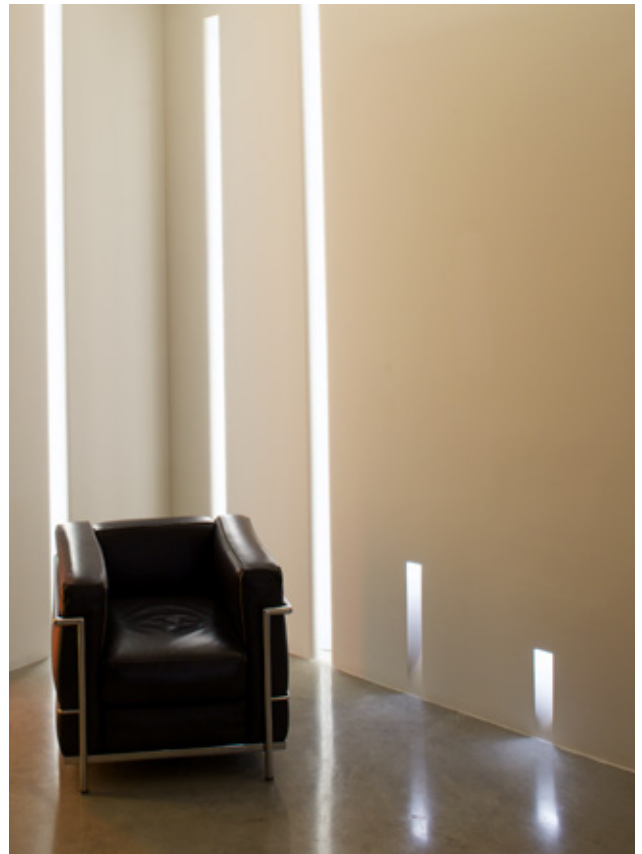

SOFTPROFILE DECO

Designed by Philippe Starck/Marcel Wanders

DECO STARCK



DECO WANDERS

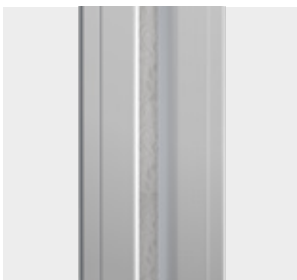

Find out more at
flos.com/softprofiledeco

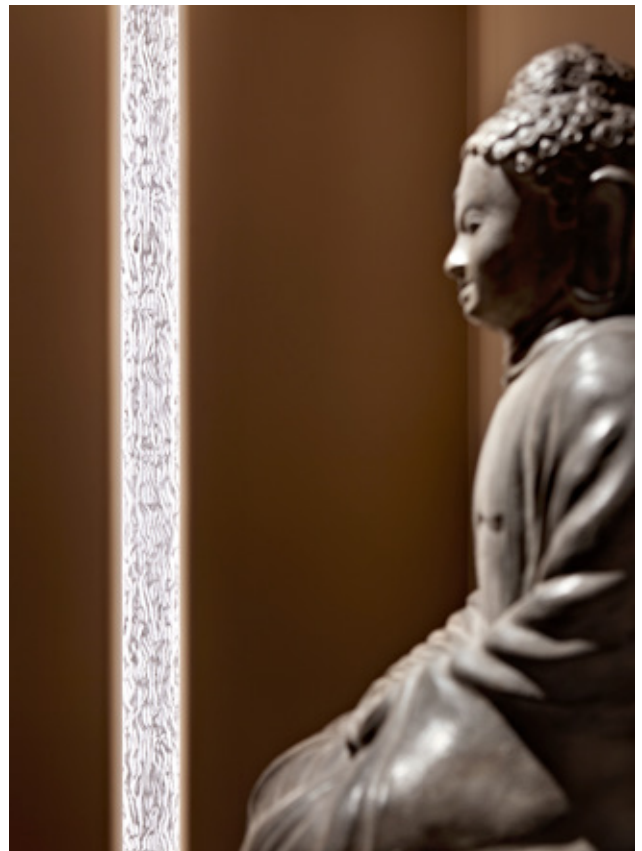

JUNCOS

Designed by Flos Soft Architecture

Luminaire s'inspirant des groupes de joncs qui apparaissent à la surface de l'eau. Doté d'une LED haute puissance, le tube peut se basculer et s'introduire ou sortir du plafond pour orienter le faisceau de lumière et créer la composition désirée.

Luminaire inspired by 'bunches of reeds' hovering over the water surface. With a high power LED, the tube can be tilted and inserted or removed from the ceiling to direct the beam of light and create the desired artistic composition.

JUNCOS 1L



JUNCOS 6L

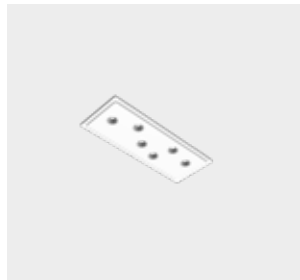

JUNCOS 250 mm



JUNCOS 3L



JUNCOS 9L

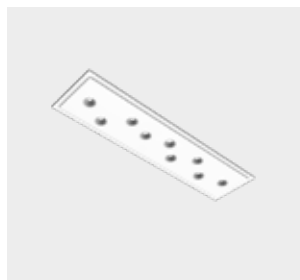

JUNCOS 400 mm



Find out more at
flos.com/juncos



SOFT SPUN

Designed by Sebastian Wrong

Lampe conçue pour générer un impact visuel minimum. Installation par encastrement dans les cloisons en plaques de plâtre. Disponible avec des sources de lumière halogène sur secteur, à éclairage direct, lumière fluoescence et LED. Toutes comprennent un verre de sécurité opale.

Lamp designed for minimal visual impact that is flush mounted to plasterboard walls. Available with halogen light sources connected directly to mains, fluorescent and LED lights sources. All of them include opal safety glass.

SMALL

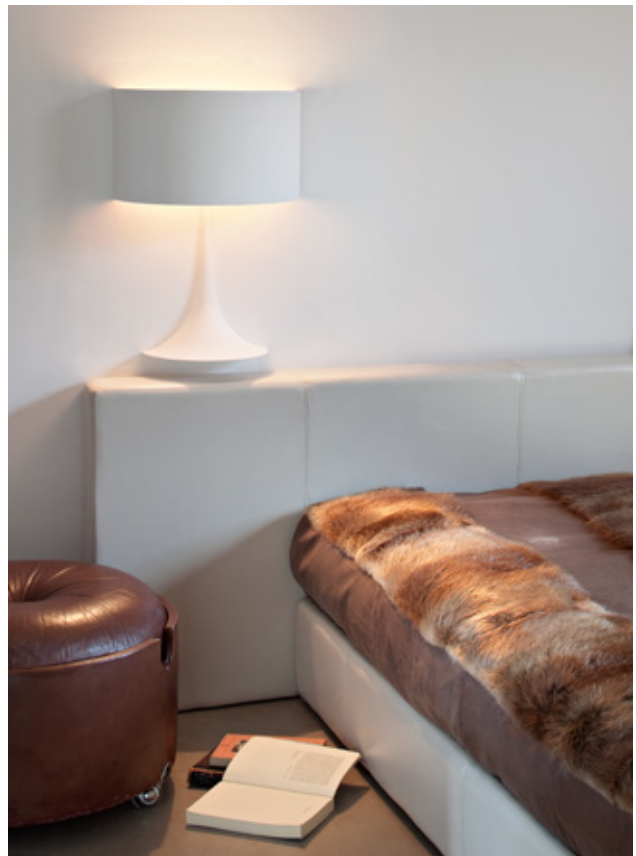

LARGE



Find out more at
flos.com/softspun

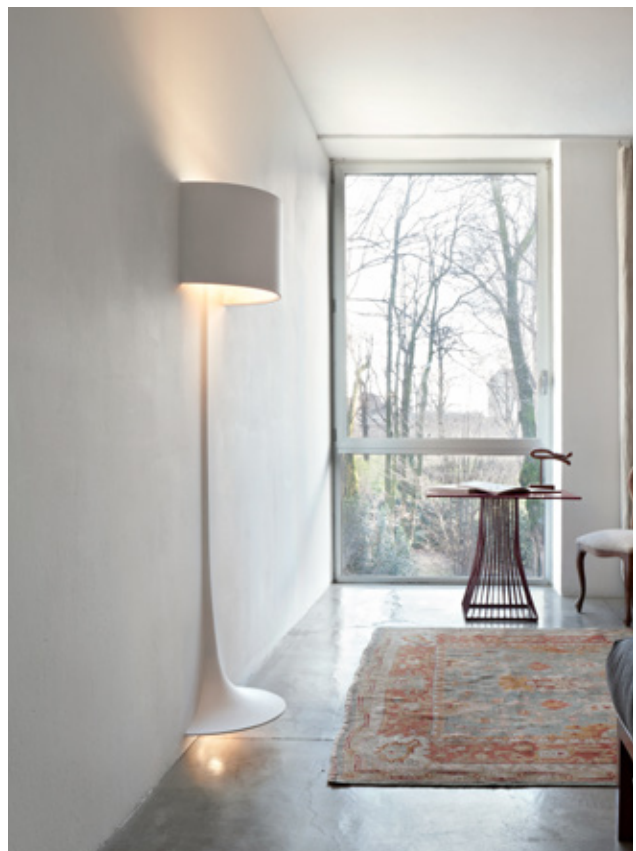



Virgin Active, Portugal



ABAJOUR'D'HUI

Designed by Flos Soft Architecture

Lampe conçue pour générer un impact visuel minimum. Installation par encastrement dans les cloisons en plaques de plâtre. Disponible avec des sources de lumière halogène sur secteur, à éclairage direct, lumière fluoescence et LED. Toutes comprennent un verre de sécurité opale.

Lamp designed for minimal visual impact that is flush mounted to plasterboard walls. Available with halogen light sources connected directly to mains, fluorescent and LED lights sources. All of them include opal safety glass.

SMALL



Verbano Hotel, Italy

LARGE



Find out more at
flos.com/abajourd'hui



Beau Riage Hotel, France



Private House, Geneva

USO

Designed by Flos Soft Architecture

Famille de luminaires réalisés avec la technologie Soft Composite et compatibles avec le projet FLOS architectural. Disponible dans plusieurs dimensions et formes ainsi qu'en versions 1L et 2L, la famille Uso offre une grande variété de solutions d'éclairage, en garantissant toujours une parfaite intégration dans l'espace architectural.

Family of luminaires manufactured with Soft Composite technology and designed to house FLOS architectural project. Available in several sizes and shapes, as well as in 1L and 2L versions, the Uso family offers a wide variety of lighting solutions, always guaranteeing total integration into the architectural space.

USO 332



USO KAP 105/145

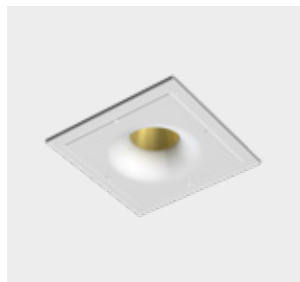

USO 700/800



USO 1000

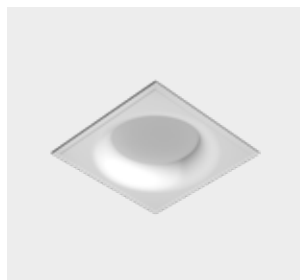

USO 1400



Find out more at
flos.com/uso

USO COVE LIGHTING

Designed by Flos Soft Architecture

Famille de luminaires réalisés avec la technologie Soft Composite et compatibles avec le projet FLOS architectural. Disponible dans plusieurs dimensions et formes ainsi qu'en versions 1L et 2L, la famille Uso offre une grande variété de solutions d'éclairage, en garantissant toujours une parfaite intégration dans l'espace architectural.

Family of luminaires manufactured with Soft Composite technology and designed to house FLOS architectural project. Available in several sizes and shapes, as well as in 1L and 2L versions, the Uso family offers a wide variety of lighting solutions, always guaranteeing total integration into the architectural space.

USO 900 COVE LIGHTING



USO 1700 COVE LIGHTING



USO 2200 COVE LIGHTING



USO 2500 COVE LIGHTING



USO 100 50 COVE LIGHTING



USO 140 90 COVE LIGHTING



Find out more at
flos.com/usocovelighting



G-O IN

Designed by Jorge Herrera

Luminaire mural à LED, spécifiquement conçu pour le balisage d'intérieurs tels que les couloirs, escaliers, etc. Conçu avec la technologie Soft Composite, il s'intègre parfaitement dans l'espace architectural. Disponible en lumières blanche, ambre ou bleue, selon les besoins du projet d'éclairage.

LED wall luminaire, specifically designed for indoor signage of corridors, stairs, etc. Fitting combined with Soft Composite technology integrates perfectly into the architecture. Available with white, amber or blue light depending on the needs of the lighting project.



Find out more at
flos.com/go-in





Private House, Holland



Private House, Netherlands

TEARDROP

Designed by Calvi Brambilla

Downlight rond disponible en plusieurs diamètres. Luminaire conçu pour un impact visuel minimum en plâtre. La source de lumière est positionnée en retrait pour un plus grand confort visuel. Installation sur plafond en plaques de plâtre.

Round downlight available in several diameters designed for minimal visual impact made of plaster. The light source is installed in a deep position, to achieve high visual comfort. Plasterboard ceiling-mounting.

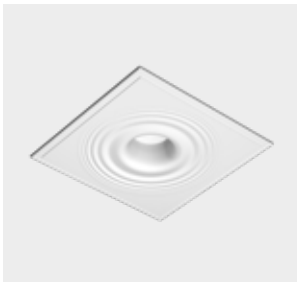

Find out more at
flos.com/teardrop



ROUND, SQUARE & VERTICAL LIGHT

Designed by Flos Soft Architecture

Appareil d'éclairage encastrable pour une installation murale/au plafond en intérieur. Disponible en versions ronde/carrée/rectangulaire. Conçu pour se fondre dans l'environnement et générer un impact visuel minimum, la famille Round, Square & Vertical Light comprend un écran intégré à l'intérieur et un verre de diffusion en polycarbonate.

Recessed light fitting for interior wall and ceiling mounting. Available in round/square/rectangular versions. Designed to blend in with the surroundings and generate minimal visual impact, the Round, Square & Vertical Light family incorporates a screen on the inside as well as a diffuser polycarbonate lens.

ROUND

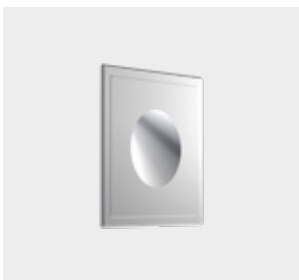

Find out more at
flos.com/roundlight

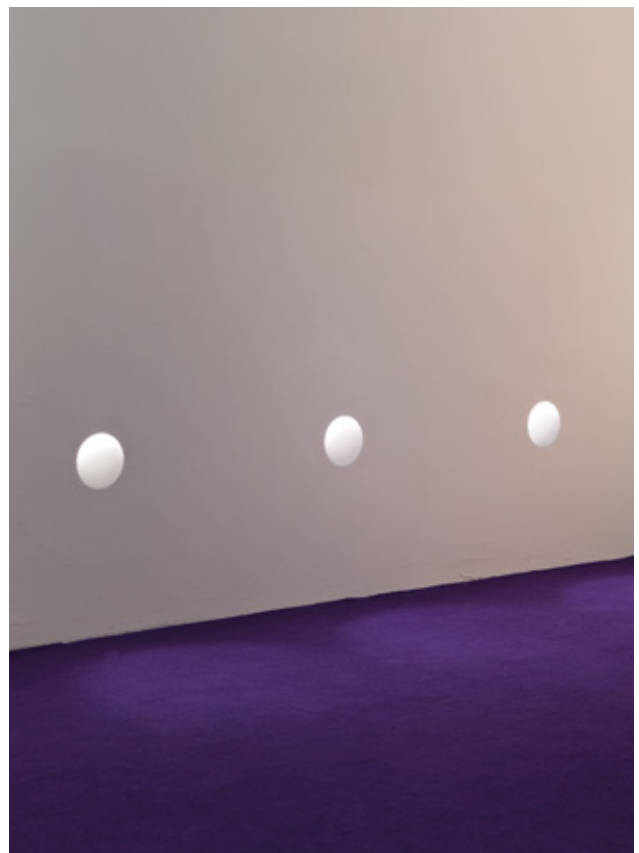

SQUARE



Find out more at
flos.com/squarelight

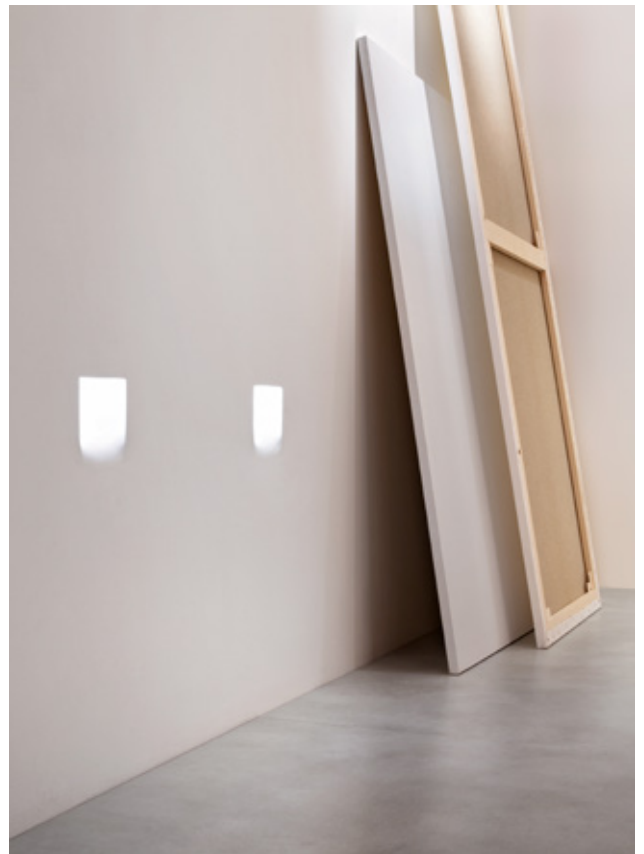

VERTICAL



Find out more at
flos.com/verticallight

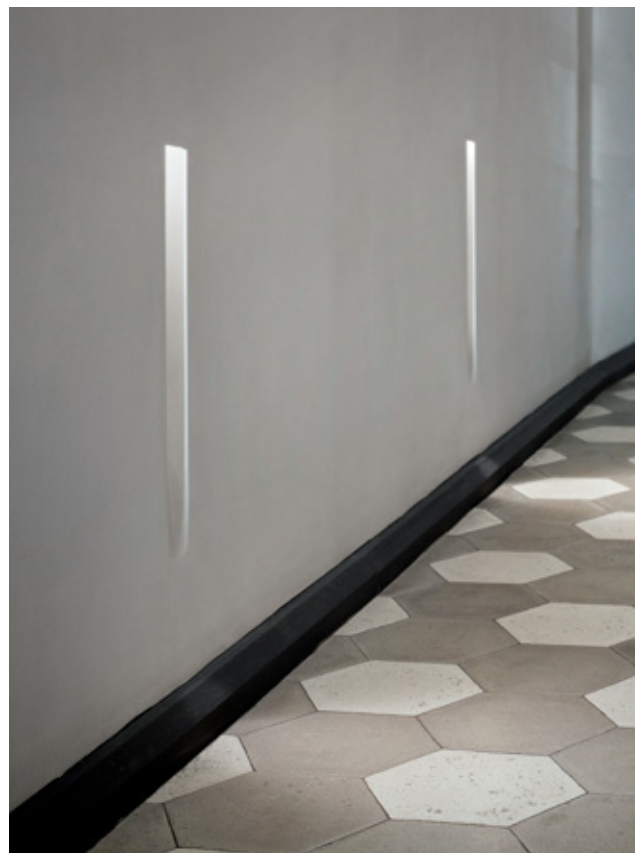

Sempione Cafe, Italy

DISTRIBUTION

**BELGIUM
AND LUXEMBOURG**
Flos Belux
M +32 474 739 080
flosbelux@flos.com

NORWAY
Drammensveien 120
0277 Oslo - Norway
Tel +47 2212 86 00
Fax +47 2212 86 08
info.norge@flos.com

SWEDEN
FLOS Sweden
Lützengatan 1
11520 Stockholm
Sweden
Tel +4686604405
info.se@flos.com

DENMARK
FLOS Scandinavia A/S
Kuglegaardsvej 13-17
1434 Copenhagen K
Denmark
Tel +4533886000
info.dk@flos.com

AMSTERDAM
Cruquiusweg 109S
1019 AG Amsterdam
The Netherlands
Tel +31 (0) 20 560 50 60
flosnetherlands@flos.com

FRANCE
Flos France
20-22, Passage Dauphine
75006 Paris
Tel +33 (0) 1 40 64 17 44
flos.france@flos.com

**AUSTRIA - GERMANY
SWITZERLAND**
Flos GmbH
Obermünsterstraße 18
93047 Regensburg,
Germany
Tel +49 941 630837 00
Fax +49 941 630837 60
info@flos-gmbh.de

UNITED KINGDOM
Atrium Ltd.
28 Leonard Street
EC2A 4BY London
Tel +44 (0) 20 7681 9933
Fax +44 (0) 20 7681 9943
flos@atrium.ltd.uk

UNITED KINGDOM
International Projects
Boccia Giandonato
tel +44(0)20 7681 9933
giandonato.boccia@flos.
com

JAPAN
Flos Japan K.K.
Hulic Aoyama 2nd Bldg 2F
1-3-3 Shibuya Shibuya-ku
Tokyo - Japan
Tel: +81 (0)3 6421 0840
flos.japan@flos.com

ASIA PACIFIC
Flos Representative Office
Antares Iluminacion
Pte Ltd
50 Raffles Place, #30-00
Singapore Land Tower
Singapore 048623
+6590056328
+6591267780

CHINA
Flos Illumination
(Shanghai) Co. Ltd.
Unit 101, Floor 1,
Building B9
No. 800 of Chang De road
Jing An District, Shanghai,
200040, China
Tel +86 021 62176187
floschina@flos.com
(South China)
Tel +86 1392 9975 703
alan.wong@flos.com

LATIN AMERICA
Flos LatAm
M +52 55 6960 1772
flos.latinamerica@flos.com

INDIA
Flos Representative Office
1, Commonwealth Lane
#08-12, 149544 Singapore
Tel +91 9999306667
Fax +65 (0) 6372 7607
flosindia@flos.com

U.S.A.
Flos USA Inc.
40-20 22nd Street -
3rd Floor
Long Island City, NY 11101
Tel +1 (800) 841 4011
info@flosusa.com

MIDDLE EAST
Antares Iluminacion S.A.
Dubai Design District
Building 1B, Office 303
P.O.Box number 333025
Dubai, United Arab
Emirates
Tel: +971 4 566 0123
Mob: +971 543567356

HONG KONG
M +852 9307 3713
flosasia@flos.com

SHOWROOMS

STOCKHOLM
FLOS Sweden
Lützengatan 1
11520 Stockholm
Sweden
Tel +4686604405
info.se@flos.com

COPENHAGEN
FLOS Scandinavia A/S
Kuglegaardsvej 13-17
1434 Copenhagen K
Denmark
Tel +4533886000
info.dk@flos.com

AMSTERDAM
Cruquiusweg 109S
1019 AG Amsterdam
The Netherlands
Tel +31 (0) 20 560 50 60
showroom.amsterdam@
flos.com

OSLO
Drammensveien 120
0277 Oslo - Norway
Tel +47 (0) 2212 86 00
Fax +47 (0) 2212 86 08
info.norge@flos.com

MILANO
Corso Monforte, 15
20122 Milano
Tel +39 02 79 84 57
Fax +39 02 89 78 56 41
showroom.milan@flos.com

PARIS
20-22, Passage Dauphine
75006 Paris
Tel +33 (0) 1 40 64 17 44
flos.france@flos.com

TOKYO
PMC Building 8F
1-23-5 Higashiazabu
Minato-Ku
Tokyo 104-0044
Tel: +81 (0)3 3582 1468
Fax: +81 (0)3 3582 0974
showroom.tokyo@flos.com

FLAGSHIP STORES

MILANO
Corso Monforte, 9
20122 - Milano
Tel +39 02 37011080
Fax +39 02 780833
shop.milan@flos.com

ROMA
Via del Babuino, 85
00187 - Roma
Tel +39 06 3207631
Fax +39 06 3207690
flosroma@flos.com

NEW YORK
135 Madison Ave
New York, NY 10016
Tel +1 212 941 4760
Fax +1 212 941 4763
info@flosusa.com

PARIS
15, Rue de Bourgogne
75007 - Paris
Tel +33 (0) 1 53 85 49 93
Fax +33 (0) 1 53 85 49 99
flosparis@flos.com

LYON
17 Rue Jarente
69002 - Lyon
Tel +33 478621301
Fax +33 478622119
floslyon@flos.com

STOCKHOLM
FLOS Sverige
Lützengatan 1
11520 Stockholm
Sweden
Tel +46086604405
info.se@flos.com

CONTACT

ITALY

Flos Spa
Via Angelo Faini, 2
25073 Bovezzo (Brescia)
Tel +39 0302438.1
Fax +39 0302438.250
info@flos.com

SPAIN

Antares Iluminación S.A.U.
Calle Mallorca, 1
Polígono Industrial Reva
46394 Ribarroja (Valencia)
Tel +34 96 166 95 20
Fax +34 96 166 82 86
flos.architectural@flos.com

IN-PLACE
PHOTOGRAPHY

Adam Letch
Adrian Houston
Aleš Jungmann
Alexandros Pissourios
Anarchitect I
Andrew Krucko
Andrew Latreille
Andy Spain
Andy Stagg
Ángel Rosique
Photography
B2Ai – fotograaf Bart
Heijmans
Beeldpunt
Bernard Andre
BIS images
Bouroullec Studio
Boys Plays Nice
Brian W. Ferry
Bruno Rondinelli
C. Taylor Crothers (CTC)
Celine de Gussem
Cesare Chimenti
Chiel de Nooyer
Clarysse Valerie, HC
Connie Zhou
CTC Creative
David Frutos
Diana di Nitto
EK Yap Creative &
Photography
Erlantz Biderbost
Eugeni Pons
Fabio Gambina
Federica Cartlet
Federico Torra
Fernando Alda
Francesco Caredda
Fraser Marsden
Frederik Vercrusse
Germán Cabo
Germano Borrelli
Gionata Xerra
Héctor Santos
Jabali Studio
Javier Bravo
Javier Márquez
Javier Orive

Jesús Granada
Joao Morgado
Julian Walter
Killian O'Sullivan
Kris Dekeijser
LevaSaudargaite
Liesbeth Goudenhoof
Lindman Photography AB
Mariela Apollonio
Matt Chisnall
Mattia Greggi
MaxRommel
MCM and The Estee
Lauder Companies UK &
Ireland
Michel Giesbrecht &
Studio Bouroullec
Moriq interiors and Design
Consultans
Olivier Baco
Omar Sartor
Pere Peris
Petra Kleis
Pia Riverola
PIAGGIO Fast Forward
RBA / Eugeni Pons
RBA ImagesBIS images
Roland Halbe
Rubén P. Bescós
Santi Caleca
Schwarz – Licht
Shuhe
Simona Rota
Simone Bossi
Studio Moost / Studio
Tomorrow
Tamas Bujnovszky / BE
LIGHT!
Tommaso Sartori
Valerie Clarysse / Beelpunt
Photography
Victoria Muñoz
VIEW / Andy Stagg
VIEW / Ed Reeve
VIEW / Francesco Russo
Volker Conradus
Woo-Jin Park

CREDITS

ART DIRECTION
Apartamento Studios

GRAPHIC DESIGN
Apartamento Studios

PHOTO INTEGRATION
Mozing Studio
Jorge Herrera Studio

PHOTO PRODUCT
Piero Fasanotto
Alessandro Lourenço

LAYOUT
Flos Architectural Team

PRODUCT INFORMATION
UPDATE
01-02-2024

EDITION
01-02-2024
Copyright © Flos 2024
All rights reserved

ACKNOWLEDGEMENTS

05AM Arqtes	Issey Miyake	United Nations
Alex March	Itínere Baqueira	Val Office
Alfons & Damian	Jorge Herrera	Versace
Anarchitect	Kitoko	Viccarbe
Andreu World	Klaarchitectuur Offices	Víctor Bergnes
AntwerpPhoto	Kvadrat	Victoria Beckham
Arassociati	Lardini	VIEW Pictures Ltd / Alamy
Archiproducts	Lighting Workshop	Vincent Van Duysen Studio
Arclinea	Lightpoint	Vincenzo De Cotiis
Axiom Consulting Partners	Lissoni & Partners	Architects
Babel Studio	LOFT4C	Virgin Active
Barbara Balestreri	Lukas Lighting	Voltaire
BassamFellows Inc.	Luminae Lighting Design	White Houses
Beeldpunt	Marco Costanzi Architets	Zusa
B&B Italia	Marcos Catalán	
Bombas Gens	Maxime De Campenaer	
Bombi/Gómez	MCM	
Boubau	MLD	
Boys Plays Nice	Moba Showroom	
Budapest	Mobitec	
BURO B	Molteni	
Carbonado Energy	Moremas Arquitectos	
Carhartt	Mount Sinai Hospital	
Central European	Natixis	
University	Negre Estudio	
Claudio Castellini	O'Donnell + Tuomey Ltd.,	
Conran and Partners	Palazzo Reale Milano	
Cosín Showroom	Park 51	
COULON & Ass	Peia Associati	
Curiosity	Pepe Cabrera	
De Witte Duif	Piaggio Fast Forward	
Emilio Nanni	Pitsou Kedem	
Estee Lauder	Poliform	
EstudiHac	Porcelanosa	
Estudio Querencia	RBA / Eugeni Pons	
Fabio Fantolino	Renzo Piano	
Familia Parrón-Ortiz	RF Dubai	
Fantini	Ricardo de Landaluce	
Fogarty Finger	RNB	
Fran Silvestre	Roberto Falconi - Falconi	
Francesco Caredda	Architettura	
Franco Scaglia	Ronan & Erwan Bouroullec	
Gandía Blasco	Rossano Ferretti	
Gomarco	Sergio Rossi	
Gyro Toys	Studio Civico 46	
Hakei	Studio Tronconi Architetti	
Hans Abaton	Teampannon Kft	
IN56 Interiorismo	The Conran Shop & APT	
INC Architecture & Design	Design	
PLLC	The KaDeWe Group	
Iñigo Beguiristain	TPG Architecture	

Comme notre monde est en constante évolution, des changements techniques apparaissent chaque jour dans notre activité.

L'objectif de Flos est de toujours offrir la meilleure technologie disponible, en révisant constamment nos produits et en les mettant à jour dès que des évolutions technologiques présentent des avantages pour nos partenaires et nos clients.

Cette philosophie signifie que notre catalogue et nos fiches techniques sont aussi en constante évolution et nécessitent des mises à jour et des révisions permanentes.

Ainsi, lorsque vous avez besoin de détails techniques et des dernières informations produits, veuillez consulter la section produit de notre site officiel flos.com : il est mis à jour quotidiennement et vous y trouverez les dernières informations produit, les codes des produits disponibles, et tous les catalogues à télécharger.

www.flos.com

As our world is in constant evolution, technical upgrades happens every day in our business.

Flos aim is to offer always the best reliable technology available, constantly reviewing our products and upgrading them as soon as technologic evolutions offers benefits for our partners and clients.

This philosophy means that our technical catalogue and product data sheets also are in constant evolution, requiring upgrades and constants reviewing.

Thus, when you need technical details and the most recent product information, please browse the product section of our Flos.com official website: it is updated daily, and there you'll find the latest product details, all available part numbers, all product documents available for immediate download.

www.flos.com

THE RUNNING MAGNET, THE TRACKING MAGNET,
THE TRACKING POWER, THE FAST TRACK, IN-
FINITY, LIGHT CUT MINI, GUSTAVE, EMI, OBLIQUE,
OBLIQUE FLOOR, WORKMATES, LIGHT SHADOW,
LIGHT SHADOW DOTS, LIGHT SHADOW PRO,
ECLECTIC, CIRCLE OF LIGHT, LED CURTAIN, KAP,
BON JOUR, UT DOWNLIGHT, LIGHT SUPPLY, WAN
DOWNLIGHT, JOHNNY, LIGHT SHADOW SPOT,
CAMERA, FIND ME, UT SPOT, WAN SPOT, C1, UT
PRO SURFACE, KAP SURFACE, SUPER LINE, SUPER
LINE PRO, SUPER FLAT, LIGHT BELL, FORT KNOX
WALL, THIN LED, G-O, THEBLOCKOFFLIGHT, WALL
RUPTURE, SOFTPROFILE, JUNCOS, SOFT SPUN,
ABAJOURD'HUI, G-O IN, TEARDROP, USO, USO COVE
LIGHTING, ROUND, SQUARE & VERTICAL LIGHT.