

Dining

2023

Molteni & C

CONTENT

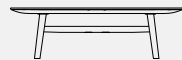

Tables

pp 10-113



Home office

pp 114-137



Chairs

pp 138-205

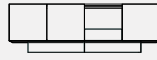

Single furniture
and bookcases
pp 206-289



Mirrors

pp 290-293

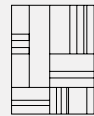

Carpet
collection
pp 294-325

OVERVIEW

TABLES



Arc
Foster + Partners - p. 98



Asterias
Patricia Urquiola - p. 82



Ava Table
Foster + Partners - p. 72



Blevio
Ignazio Gardella - p. 42



D.859.1
Gio Ponti - p. 64



Diamond
Patricia Urquiola - p. 106



Filigree
Rodolfo Dordoni - p. 90



Gatwick
Rodolfo Dordoni - p. 76



Half a Square
Michael Anastassiades - p. 52



Mateo
Vincent Van Duysen - p. 12



Old Ford
Rodolfo Dordoni - p. 32

HOME OFFICE



D.847.1
Gio Ponti - p. 116

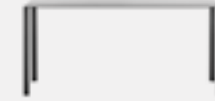

LessLess
Jean Nouvel - p. 134



Note
Matteo Nunziati - p. 126

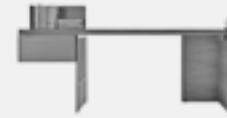

Scriba
Patricia Urquiola - p. 130



Touch Down Unit
Studio Klass - p. 120



OVERVIEW

CHAIRS



Alfa
Hannes Wettstein - p. 202



Barbican
Rodolfo Dordoni - p. 170



Chelsea
Rodolfo Dordoni - p. 186



Devon
Rodolfo Dordoni - p. 160



D.235.1 Montecatini
Gio Ponti - p. 176



Glove / Glove-Up
Patricia Urquiola - p. 192 / p. 196



Janet
Vincent Van Duysen - p. 150



MHC.3 Miss
Tobia Scarpa - p. 180



Outline
Arik Levy - p. 198



Porta Volta
Herzog & de Meuron - p. 140



Tea
Jasper Morrison - p. 154



Woody
Francesco Meda - p. 166

SINGLE UNITS



45°/Vetrina
Ron Gilad - p. 274



Carteggio
Aldo Rossi - p. 288



Living Box
Vincent Van Duysen - p. 218



Teorema
Ron Gilad - p. 246



Adrien
Vincent Van Duysen - p. 236



D.655.1 D.655.2
Gio Ponti - p. 258



MHC.1
Werner Blaser - p. 262



Archway
Rodolfo Dordoni - p. 208



Horizons
Dante Bonuccelli - p. 234



Quinten
Vincent Van Duysen - p. 270



OVERVIEW

BOOKCASES

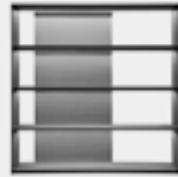

Ava
Foster + Partners - p. 242



D.355.1 D.355.2
Gio Ponti - p. 250



D.357.1 D.357.2
Gio Ponti - p. 254

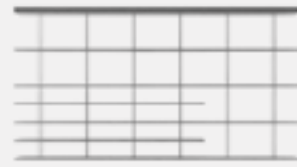

Graduate
Jean Nouvel - p. 278



MHC.2
Yasuhiko Itoh - p. 266



Piroscapo
Aldo Rossi, Luca Meda - p. 284

MIRRORS

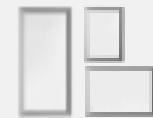

D.9501
Gio Ponti - p. 290



Hector Mirror
Vincent Van Duysen - p. 292

CARPET COLLECTION



D.754.1
Gio Ponti - Heritage Collection - p. 296



Atalante
by Ruckstuhl - Nicola Gallizia - p. 298



Aura
Nicola Gallizia - p. 300



Corba
Marta Ferri - p. 302

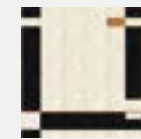

Dedalo
by Pierre Frey - Marta Ferri - p. 304



Duna
Nicola Gallizia - p. 306



Edge
Nicola Gallizia - p. 308



Hem
by G.T.Design - Patricia Urquiola - p. 310



Loop&Cut
by G.T.Design - Patricia Urquiola - p. 312

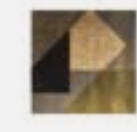

Mosaico
Marta Ferri - p. 314



Palette
Nicola Gallizia - p. 316



Random
by Altai - Patricia Urquiola - p. 318



Stripe
Vincent Van Duysen - p. 320



Telaro
by Amini - Marta Ferri - p. 322



Vibrazioni
Marta Ferri - p. 324



MOLTENI MAKE FURNITURE BY BUILDING ON TRADITION, ADDING EXPERIENCE TO EXPERIENCE. BY APPLYING TECHNICAL INNOVATION TO TIME-HONOURED SKILLS THEY ACHIEVE UNEXPECTED, INGENUOUS ADVANCES. THE DURABILITY OF FURNITURE DEPENDS ON GOOD WORKMANSHIP BUT ALSO ON THE COMPLETENESS AND SUITABILITY OF THE FORMS. MATERIALS HAVE TO BE “GOOD” MATERIALS, BUT ARE ONLY SUCH IF USED IN KEEPING WITH THEIR POTENTIAL, THEIR HISTORY AND THEIR PURPOSE.

MOLTENI COSTRUISCE MOBILI SVILUPPANDO LA TRADIZIONE. AD ESPERIENZA AGGIUNGE ESPERIENZA. L'INNOVAZIONE TECNICA CONSENTE DI SVILUPPARE IN DIREZIONI IMPREVISTE I RISULTATI SEDIMENTATI DAL TEMPO. LA DURATA DEI MOBILI È LEGATA ALLA BUONA FATTURA, MA ANCHE ALLA COMPIUTEZZA E ALL'ADEGUATEZZA DELLE FORME. I MATERIALI DEVONO ESSERE “BUONI” MATERIALI, MA DIVENTANO TALI SE SONO COERENTI CON LE LORO POSSIBILITÀ, CON LA LORO STORIA E IL LORO USO.

tables



MATEO

VINCENT VAN DUYSSEN

The Mateo table is composed of a slightly flared cylindrical pedestal base, which has been divided vertically in two. The top - available in both rounded and oval versions - tapers subtly at the edges, allowing it to blend in perfectly with a wide range of environments. The base is available in either coffee Oak, Sunrise Oak, burnished metal or the whole range of glossy lacquers. The Mateo table is available in two versions: dining and lounge. The 74 cm high dining version is available in lacquered finish in all the colours of the Molteni&C catalogue, coffee Oak and Sunrise Oak essence. The top is either round, with 140, 160, and 180 cm diameters, or oval with 220 and 250 cm lengths. For an even more precious version, calacatta, emperador dark, black marquina marble finish is available in a matte or glossy polyester version. The round top is available in 140, 160, 180, and 200 cm, while the oval is available in 220 and 250 cm. The finishes range from coffee Oak, which embodies warm brown facets and tones, to a warmer Sunrise Oak to glossy lacquers in the entire Molteni&C range, as well as calacatta, emperador dark and black marquina marbles. In addition, two new colours have been introduced to the lacquer palette: pine green, which recalls the typical dark green colour of coniferous trees in the winter, and almond white, a sophisticated milky shade. Mateo can include the addition of a rotating central element, Lazy Susan, which allows all diners to be served in a practical way, creating intimate moments of conviviality. The tray, available in calacatta, emperador dark, and black marquina marble, is developed in two diameters: 80 cm (for the 160 and 180 cm tables) and 100 cm (for the 200 cm table).

Il tavolo, dotato di un piedistallo centrale dalla forma cilindrica e conica solcata in due nella verticale alla base, è disponibile in versione tonda o ovale rastremate sul bordo, adattandosi perfettamente ad ogni tipologia di ambiente. La gamba è disponibile in rovere caffè, rovere sunrise, nell'intera gamma dei laccati lucidi e in metallo brunito. Il tavolo Mateo è disponibile in due versioni: dining e lounge. La versione dining ha un'altezza di 74 cm mentre la lounge di 64 cm. La versione dining è disponibile con il piano tondo nelle dimensioni 140, 160, 180, 200 cm mentre quello ovale in 220 e 250 cm. La versione lounge ha un piano tondo nei diametri 120 o 140 cm. Le finiture spaziano dal rovere caffè, che racchiude in sé le sfaccettature e i toni del caffè, al più caldo rovere sunrise, ai laccati lucidi in tutta la gamma Molteni&C fino ai marmi calacatta, emperador dark e nero marquina. Nella palette dei laccati entrano due nuove colorazioni: il pine green, che richiama il tipico colore verde scuro dei pini durante il periodo invernale e l'almond white, un sofisticato bianco latte. Mateo può prevedere l'aggiunta di un vassoio centrale girevole, Lazy Susan, che permette di servire in maniera pratica tutti i commensali, creando intime situazioni di convivialità. Il vassoio, disponibile in marmo calacatta, emperador dark e marquina, è sviluppato in due diametri: 80 (per i tavoli da 160 e 180 cm) e 100 (per il tavolo da 200 cm). Un moderno concetto di dining: un tavolo dalle proporzioni scalabili e dalle linee pulite, pensato per l'arte del ricevere.



MATEO —

OVAL DINING TABLE—
ALMOND WHITE
GLOSSY LACQUER
BASE AND TOP
JANET CHAIRS—
505 UP SIDEBOARD—
EDGE CARPET—

TAVOLO DINING OVALE—
BASAMENTO E PIANO
LACCATO LUCIDO
ALMOND WHITE
SEDIE JANET—
505 UP SIDEBOARD—
TAPPETO EDGE—





MATEO —

OVAL DINING TABLE—
COFFEE OAK
BASE AND TOP
JANET CHAIRS—
ATALANTE CARPET—

TAVOLO DINING OVALE—
BASAMENTO E PIANO
ROVERE CAFFÈ
SEDIE JANET—
TAPPETO ATALANTE—



MATEO —

ROUND DINING TABLE
WITH LAZY SUSAN—
BURNISHED MATT
LACQUER BASE,
CALACATTA MARBLE TOP
PORTA VOLTA CHAIRS—
STRIPE CARPET—

TAVOLO DINING ROTONDO
CON LAZY SUSAN—
BASAMENTO
LACCATO OPACO BRUNITO,
PIANO MARMO CALACATTA
SEDIE PORTA VOLTA—
TAPPETO STRIPE—



MATEO —

OVAL DINING TABLE—
PEWTER GLOSSY LACQUER
BASE AND TOP
JANET CHAIRS—
AURA CARPET—

TAVOLO DINING OVALE—
BASAMENTO E PIANO
LACCATO LUCIDO PELTRO
SEDIE JANET—
TAPPETO AURA—



MATEO —

ROUND DINING TABLE—
PINE GREEN GLOSSY LACQUER
BASE AND TOP
JANET CHAIRS—
PALETTE CARPET—

ROUND DINING TABLE—
SUNRISE OAK BASE,
CALACATTA MARBLE TOP

TAVOLO DINING ROTONDO—
BASAMENTO E PIANO
LACCATO LUCIDO PINE GREEN
SEDIE JANET—
TAPPETO PALETTE—

TAVOLO DINING ROTONDO—
BASAMENTO ROVERE SUNRISE,
PIANO MARMO CALACATTA



MATEO —

ROUND DINING TABLE—
BURGUNDY GLOSSY LACQUER
BASE AND TOP
DUNA CARPET—

TAVOLO DINING ROTONDO—
BASAMENTO E PIANO
LACCATO LUCIDO BORGOGNA
TAPPETO DUNA—





MATEO —

ROUND LOUNGE TABLE—
COFFEE OAK
BASE AND TOP
PORTA VOLTA CHAIRS—

TAVOLO LOUNGE ROTONDO—
BASAMENTO E PIANO
ROVERE CAFFÈ
SEDIE PORTA VOLTA—



MATEO —

ROUND LOUNGE TABLE
WITH LAZY SUSAN—
BURNISHED MATT
LACQUER BASE,
CALACATTA MARBLE TOP
PORTA VOLTA CHAIRS—
ATALANTE CARPET—

TAVOLO LOUNGE ROTONDO
CON LAZY SUSAN—
BASAMENTO
LACCATO OPACO BRUNITO,
PIANO MARMO CALACATTA
SEDIE PORTA VOLTA—
TAPPETO ATALANTE—



MATEO —

ROUND LOUNGE TABLE—
BURNISHED MATT
LACQUER BASE,
CALACATTA MARBLE TOP
PORTA VOLTA CHAIR—
ATALANTE CARPET—

TAVOLO LOUNGE ROTONDO—
BASAMENTO
LACCATO OPACO BRUNITO,
PIANO MARMO CALACATTA
SEDIA PORTA VOLTA—
TAPPETO ATALANTE—



OLD FORD

RODOLFO DORDONI

The Old Ford table by the Italian designer Rodolfo Dordoni is a perfect embodiment of a commitment by Molteni&C in combining aesthetics, functionality, and technical innovation. The table is composed of a rounded, lozenge-shaped top that curves downward on the underside to meet four glossy lacquered legs connected by an H-shaped beam. The finely worked top is available with the choice of limba and coffee oak wood finishes, and in emperador dark, calacatta and sahara noir marble in in matt and glossy polyester version, giving it a warm and inviting appearance. The table under-top resembles a shell composed of soft lines. It is available in anthracite colour, which gives it an elegant and modern look. The contrasting-coloured legs are available in three glossy lacquered finishes, burgundy, pine green, and black nickel. The table's supportive frame is made using hydroforming, a sophisticated process commonly used in the automotive industry that uses water pressure to give shape to the material. This process allows the table to be lightweight yet strong and structurally rigid, ensuring that it can withstand the test of time. With measurements of 250 x 120 cm, or 290 x 130 cm and a height of 74 cm, the table provides ample space for seating, dining or even as a sculptural centerpiece in a foyer. The oval shape also allows the table to fit into various room layouts, making it a versatile option for any home.

Il tavolo Old Ford del designer italiano Rodolfo Dordoni incarna perfettamente l'impegno di Molteni&C nel coniugare estetica, funzionalità e innovazione tecnica. Il tavolo è composto da un piano arrotondato e sinuoso, con una sezione raccordata agli estremi che incontra un solido basamento lucido caratterizzato dal collegamento delle gambe ad una struttura ad H. Il top finemente lavorato è disponibile nelle finiture limba, rovere caffè e marmo emperador dark, calacatta, sahara noir in versione opaca e poliestere lucida che gli conferiscono un aspetto caldo e invitante. Il corpo inferiore del tavolo ricorda un guscio, caratterizzato da linee morbide. È disponibile nel color antracite, che conferisce un aspetto elegante e moderno. Le gambe, a contrasto, sono disponibili in tre finiture laccate lucide in pine green, rosso borgogna e nichel nero. La struttura portante del tavolo è realizzata mediante la tecnica dell'idroformatura, un sofisticato processo comunemente utilizzato nel settore industriale della mobilità, che sfrutta la pressione dell'acqua per plasmare la materia. Questo processo consente al tavolo di essere leggero ma strutturalmente rigido, garantendo la resistenza nel tempo. Con le misure di 250 x 120 cm o 290 x 130 cm e un'altezza di 74 cm, il tavolo offre ampio spazio per sedersi e cenare o per diventare, grazie alla sua forma caratteristica, un pezzo scultoreo al centro di un foyer. La forma ovale consente inoltre al tavolo di adattarsi a svariati layout d'interni, rendendolo un'opzione versatile per qualsiasi casa.



OLD FORD —

TABLE—
GLOSSY BLACK NICKEL
STRUCTURE,
LIMBA TOP
PORTA VOLTA CHAIR—
ARCHWAY SIDEBOARD—
EDGE CARPET—

TAVOLO—
STRUTTURA
NICKEL NERO LUCIDO,
PIANO LIMBA
SEDIA PORTA VOLTA—
MADIA ARCHWAY—
TAPPETO EDGE—





OLD FORD —

TABLE—
GLOSSY PINE GREEN
STRUCTURE,
CALACATTA MARBLE TOP
PORTA VOLTA CHAIRS—
ARCHWAY SIDEBOARD—
AURA CARPET—

TAVOLO—
STRUTTURA
PINE GREEN LUCIDO,
PIANO MARMO CALACATTA
SEDIE PORTA VOLTA—
TAPPETO AURA—





BLEVIO

IGNAZIO GARDELLA

Ignazio Gardella's Blevio table joins Molteni&C's Heritage Collection, inaugurating a partnership with the Gardella Historical Archive: the first episode of a relationship based on research and exchange, destined to develop over the years to come. Elegant and geometrically linear, the Blevio table is rich in design, in details that reveal themselves to the attentive eye. It is a project that focuses on the essential and on the removal of decoration for decoration's sake. The refined and unusual play of counter curves is also a structural stabilizing element: the geometric center of the semicircular extremities of the table top coincides with that of the vertical supports.

Il tavolo Blevio di Ignazio Gardella entra a far parte dell'Heritage Collection di Molteni&C, inaugurando la collaborazione con l'Archivio Storico Gardella: primo episodio di una relazione di ricerca e di scambio, destinata a svilupparsi nei prossimi anni. Elegante e dalla geometricità lineare, il tavolo Blevio è ricco di disegno, di dettagli che si svelano a un'osservazione attenta. È un progetto che si concentra sull'essenziale e sull'abbandono del decoro fine a se stesso. Il gioco di controcurve, raffinato e inedito, è anche un elemento di stabilizzazione strutturale: il centro geometrico delle estremità semicircolari del piano coincide con quello dei sostegni verticali.



HERITA-
GE COL-
LECTION





BLEVIO —

TABLE—
ECLIPSE STRUCTURE AND TOP
STRIPE CARPET—

TAVOLO—
STRUTTURA E PIANO ECLIPSE
TAPPETO STRIPE—



BLEVIO —

TABLE—
ECLIPSE STRUCTURE AND TOP
505 UP SYSTEM—
505 UP SIDEBOARD—
JANET CHAIR—
STRIPE CARPET—

TAVOLO—
STRUTTURA E PIANO ECLIPSE
505 UP SYSTEM—
505 UP SIDEBOARD—
SEDIA JANET—
TAPPETO STRIPE—





BLEVIO —

TABLE—
ECLIPSE STRUCTURE
BRECCIA CAPRAIA TOP

TAVOLO—
STRUTTURA ECLIPSE
PIANO BRECCIA CAPRAIA



BLEVIO —

TABLE—
ECLIPSE STRUCTURE
BRECCIA CAPRAIA TOP
JANET CHAIRS—

TAVOLO—
STRUTTURA ECLIPSE
PIANO BRECCIA CAPRAIA
SEDIE JANET—



HALF A SQUARE

MICHAEL ANASTASSIADES

Half a Square, a set of modern rectangular and square tables, designed by Michael Anastassiades, a Cypriot by birth who has made London his home. His project is distinctly minimalist in design but rich in his choice of materials, such as aluminium, marble, reflective glass and Eucalyptus, graphite or thermo Oak. The frame, made of brushed aluminium and painted pewter colour and green, is assembled by means of the strong pressure die cast legs. The joint between the parts determines a decorative triangular shape finished in brass which enhances the solidity of the frame and characterizes the elegance of the design. The table tops are made of green alpine, silver wave, sahara noir, calacatta marble, reflective graphene glass and Eucalyptus, graphite or thermo Oak. They come in different sizes, rectangular and square. A design where Anastassiades' engineering training almost prevailed over his skills as a designer to offer us a unique and intriguing object.

Half a Square, una serie di tavoli dal design moderno, rettangolari e quadrati, progettati da Michael Anastassiades, cipriota di nascita ma che ha fatto di Londra la sua città d'adozione. Il progetto è fortemente minimalista nel disegno ma ricco nei materiali utilizzati come alluminio, marmo, vetro riflettente ed essenza di Eucalipto, Rovere grafite o Rovere thermo. Il telaio strutturale, realizzato con estrusi di alluminio satinati e verniciati color peltro e verde, è assemblato mediante le robuste gambe pressofuse. La giunzione tra le parti, determina una geometria triangolare in finitura ottone che riassume la particolarità estetica, caratterizzandone l'eleganza e il design. I piani sono in marmo verde Alpi, silver wave, sahara noir, calacatta , in vetro riflettente grafene e in essenza Eucalipto, Rovere grafite o Rovere thermo. Proposto in diverse dimensioni rettangolari e quadrati. Un progetto dove la formazione ingegneristica di Anastassiades, prende quasi il sopravvento su quella di designer per regalarci un oggetto unico ed intrigante.



HALF A SQUARE —

TABLE—
PEWTER STRUCTURE
GREEN ALPINE MARBLE TOP
TEA CHAIRS—

TAVOLO—
STRUTTURA PELTRO,
PIANO IN MARMO VERDE ALPI
SEDIE TEA—





HALF A SQUARE —

TABLE—
SATIN GREEN STRUCTURE FINISH,
GREEN ALPINE MARBLE TOP
BARBICAN CHAIRS—
EUCALYPTUS BASE,
L216 LEATHER
PALETTE CARPET—

TAVOLO—
STRUTTURA VERDE SATINATO,
PIANO MARMO VERDE ALPI
SEDIE BARBICAN—
BASAMENTO EUCALIPTO,
PELLE L216
TAPPETO PALETTE—





HALF A SQUARE —

TABLE—
PEWTER COLOUR SATIN
FINISH STRUCTURE,
REFLECTIVE GRAPHENE GLASS TOP
DEVON CHAIRS—
BLACK OAK BASE, EXTRA L162 LEATHER
VIBRAZIONI CARPET

TAVOLO—
STRUTTURA PELTRO SATINATO,
PIANO VETRO RIFLETTENTE GRAFENE
SEDIE DEVON—
BASAMENTO ROVERE NERO,
PELLE L162
TAPPETO VIBRAZIONI—



HALF A SQUARE —

TABLE—
CHALK WHITE TOP
AND STRUCTURE—
DEVON CHAIRS—
BLACK OAK BASE,
KAOS KOBCS
AURA CARPET—

TAVOLO—
STRUTTURA E TOP
BIANCO CALCE—
SEDIE DEVON—
BASAMENTO ROVERE NERO,
KAOS KOBCS
TAPPETO AURA—



D.859.1

GIO PONTI

In 1958 Gio Ponti was enlisted to design the auditorium for the Time&Life Building at 1271 Avenue of the Americas in New York. The building housed the headquarters of Time Inc., publisher of influential historical magazines such as Time, Life, Fortune, People, and Sports Illustrated. This was Ponti's most prestigious project in New York. The D.859.1 table, designed primarily as a meeting table for up to ten people, stands out among the auditorium furnishings not only for its impressive size—over 3,60 meters long—but especially for its simple yet refined design. The legs are notable for their fine-membered modernity, creating a trapezoidal single-span bridge upon which the large tapered top conveys the idea of aerodynamics. Originally made of solid ash with bronze ferrules, it is now also available in a darker-toned wood such as Black Stained Ash. In addition to its original dimensions, the D.859.1 is available in two smaller versions that faithfully reproduce the harmony and proportions of the original design.

Nel 1958 viene affidato a Gio Ponti l'incarico di progettare l'auditorium annesso al Time&Life building, al 1271 di Avenue of the Americas a New York, sede della Time Inc., casa editrice di storiche e influentissime testate come Time, Life, Fortune, People e Sports Illustrated. È l'incarico più importante per Ponti a New York. Il tavolo D.859.1, utilizzato principalmente come grande tavolo per conferenze, fino a dieci posti, spicca tra gli arredi dell'auditorium non solo per le sue imponenti dimensioni, oltre 3,60 mt di lunghezza, ma soprattutto per il disegno raffinato ed essenziale. La base trapezoidale si impone per la sua leggerezza e modernità. Un vero e proprio ponte a campata unica, su cui poggia un piano di grandi dimensioni dalla forma affusolata che ne accentua l'aerodinamicità. Realizzato al tempo in frassino massello con puntali in ottone, viene riproposto sia in versione originale che in un legno dalle tonalità scure come il frassino tinto nero. Oltre alle dimensioni originali, D.859.1 è disponibile in due dimensioni più contenute che rispettano fedelmente l'armonia e le proporzioni del progetto originale.



D.859.1 —

TABLE—
ASH WOOD STAINED BLACK,
SATIN BRASS FEET
MHC.3 MISS CHAIRS—
BLACK ASH,
L200 LEATHER
PALETTE CARPET—

TAVOLO—
FRASSINO TINTO NERO,
PIEDI OTTONE SATINATO
SEDIE MHC.3 MISS—
FRASSINO NERO,
PELLE L200
TAPPETO PALETTE—





D.859.1 —

TABLE—
ASH WOOD IN NATURAL COLOUR,
SATIN BRASS FEET
MHC.3 MISS CHAIR—
NATURAL ASH,
PAPER CORD ECRU COLOUR
EDGE CARPET—

TAVOLO—
FRASSINO NATURALE,
PIEDI OTTONE SATINATO
SEDIA MHC.3 MISS—
FRASSINO NATURALE,
CORDA COLORE ECRÙ
TAPPETO EDGE—



D.859.1 —

TABLE—
ASH WOOD IN NATURAL COLOUR
D.655.1 CHEST OF DRAWERS—
ELM, ITALIAN WALNUT,
MAHOGANY, ROSEWOOD,
WHITE HAND-PAINTED,
SATIN BRASS
MHC.3 MISS CHAIR—
NATURAL ASH,
PAPER CORD ECRU COLOUR
EDGE CARPET—

TAVOLO—
FRASSINO NATURALE
CASSETTONE D.655.1—
OLMO, NOCE NAZIONALE,
MOGANO, PALISSANDRO,
VERNICIATO A MANO BIANCO,
OTTONE SATINATO
SEDIA MHC.3 MISS—
FRASSINO NATURALE,
CORDA COLORE ECRU
TAPPETO EDGE—



AVA TABLE

FOSTER + PARTNERS

True to their policy of designing eco-friendly buildings and furnishings, Foster + Partners have come up with a set of tables for contemporary settings. Made entirely of wood, the natural material par excellence, the Ava Table responds to the ever-increasing need for designer furniture to meet the demand for ecosustainability without forgoing the need to represent the space that every piece of furniture deserves. With its characteristic T-shaped legs, placed in a rear position with respect to the top so as to maximise its useful capacity, the table is all-one with the top, giving rise to an object that is at once compact but light in form. The skillful use of materials, combined with refined construction details, underlines the style dear to Foster+ Partners: furniture defined by its stunning formal lightness. The table comes in various sizes and the external finishes are all strictly made of quality wood veneers.

Fedele alla filosofia volta a progettare edifici e arredi rispettosi dell'ambiente, Foster + Partners progettano una serie di tavoli per ambienti contemporanei. Monomaterico, realizzato interamente in legno, materiale naturale per eccellenza e molto facilmente riciclabile, il tavolo Ava Table dà risposta al bisogno sempre più presente, nell'ambito dell'arredo di design, di soddisfare esigenze di eco sostenibilità non sacrificando il bisogno di rappresentazione dello spazio che ogni arredo deve meritarsi. Il tavolo con la sua caratteristica gamba a T svasata e posta in posizione arretrata rispetto al piano per massimizzare la sua capacità ricettiva, si raccorda senza soluzione di continuità al piano dando luogo ad un elemento compatto ma leggero nella forma. Sapiente uso dei materiali abbinati a raffinati dettagli costruttivi evidenziano il segno stilistico caro allo studio Foster + Partners al fine di ottenere arredi dotati di grande leggerezza formale. Diverse le misure disponibili e i rivestimenti esterni tutti rigorosamente in pregiata essenza.



AVA TABLE —

AVA TABLE—
WALNUT STRUCTURE AND TOP
BARBICAN CHAIRS—
EUCALYPTUS STRUCTURE
UNIQUE UE134 LEATHER SHELL
WILUNA WF536 SEAT
PASS-WORD EVOLUTION—
MOKA MATT LACQUER STRUCTURE
PEWTER FEET
STRIPE CARPET—

TAVOLO AVA TABLE—
STRUTTURA E PIANO NOCE
SEDIE BARBICAN—
STRUTTURA EUCALIPTO
SCOCCA PELLE UNIQUE UE134
SEDUTA WILUNA WF536
PASS-WORD EVOLUTION—
STRUTTURA LACCATO MOKA OPACO
PIEDINI PELTRO
TAPPETO STRIPE—



GATWICK

RODOLFO DORDONI

This table, designed by Milanese architect Rodolfo Dordoni, takes the name of London's Gatwick airport, one of the busiest in the world. A hub where cosmopolitan travellers meet every hour of the day and night on their way in or out of the U.K. capital, much like a table where people meet for dinner. It is the particular structure of twisted and criss-cross steel recalling an airplane propeller or a helicopter blade that inspired the name. The aluminium frame in several contemporary finishes, such as black nickel, pewter colour (satin finish) and iris (satin finish), supports elegant oval tops of different sizes enriched with wood or marble, selected from the Molteni&C collection.

Questo progetto di tavolo, dell'architetto milanese Rodolfo Dordoni, prende il nome da uno degli aeroporti londinesi più trafficati al mondo. Un Hub dove viaggiatori cosmopoliti si incontrano ogni ora del giorno e della notte diretti verso la capitale del Regno Unito o per partirci, similamente ad un tavolo dove ci si incontra per cenare. È la particolare struttura in alluminio ritorta e incrociata a ricordare un'elica o una pala d'elicottero che ne ha ispirato il nome. La struttura in alluminio, in diverse finiture contemporanee come il nickel nero, il peltro (satinato) e l'iris (satinato), sostiene eleganti piani ovali di diverse dimensioni impreziosite dalla presenza di essenza o marmo, tratti dalla collezione Molteni&C.

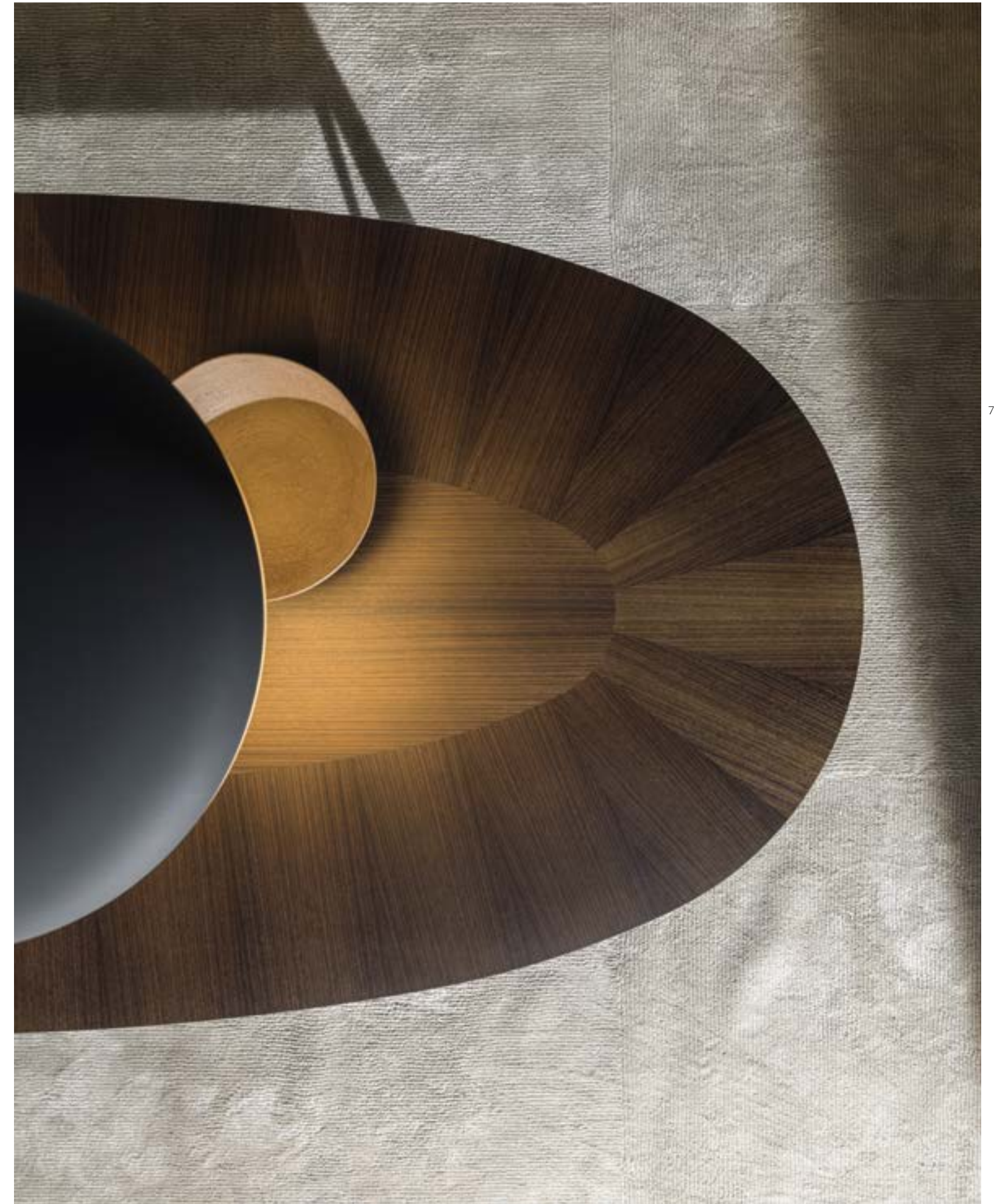

GATWICK —

TABLE—
PEWTER COLOUR STRUCTURE
EUCALYPTUS TOP
TEA CHAIRS—
PASS-WORD EVOLUTION—
STRIPE CARPET—

TAVOLO—
STRUTTURA PELTRO
PIANO EUCALIPTO
SEDIE TEA—
PASS-WORD EVOLUTION—
TAPPETO STRIPE—





GATWICK —

GATWICK TABLE—
PEWTER FINISH STRUCTURE,
SAHARA NOIR MARBLE TOP
WOODY CHAIRS—
ASH WOOD STAINED BLACK

TAVOLO GATWICK—
STRUTTURA PELTRO,
PIANO MARMO SAHARA NOIR
SEDIE WOODY—
FRASSINO TINTO NERO



ASTERIAS

PATRICIA URQUIOLA

Asterias a generously-sized round table, featuring a central base reminiscent of the cactus from which it takes its name. It consists of six curved, wedge-shaped, wooden panels, applied protruding over the central plinth. The panels are 3D printed. The top (160 or 180 cm) features a rounded edge sub-divided, into four wedges that give rise to an interesting geometric pattern. Asterias can also be fitted with a practical accessory: a central Lazy Susan turntable, very popular in Asian countries. The table is available in wood, graphite Oak, Sunrise Oak and Eucalyptus.

Asterias, un tavolo rotondo dalle dimensioni generose, caratterizzato da una base centrale che ricorda il cactus da cui prende il nome. È, infatti, composta da sei pannelli in legno curvato, a forma di spicchio, applicati a sbalzo sul plinto centrale. I pannelli sono realizzati con la particolare tecnica dello stampaggio 3D. Il piano (160 o 180 cm), dal bordo arrotondato, è suddiviso in quattro spicchi che danno luogo a un interessante disegno geometrico. Asterias dispone inoltre di un pratico accessorio: un piatto girevole centrale (Lazy Susan), molto apprezzato nei paesi asiatici. Il tavolo è disponibile in essenza, Rovere grafite, Rovere Sunrise e Eucalipto.



ASTERIAS —

TABLE—
GRAPHITE OAK
TOP, BASE AND
LAZY SUSAN
GLOVE-UP CHAIRS—
SAVANA S9322 LEATHER

TAVOLO—
PIANO, BASAMENTO,
PIATTO GIREVOLE
ROVERE GRAFITE
SEDIE GLOVE-UP—
PELLE SAVANA S9322



ASTERIAS —

TABLE—
GRAPHITE OAK
TOP, BASE AND
LAZY SUSAN
GLOVE-UP CHAIRS—
SAVANA S9322 LEATHER

TAVOLO—
PIANO, BASAMENTO,
PIATTO GIREVOLE
ROVERE GRAFITE
SEDIE GLOVE-UP—
PELLE SAVANA S9322

ASTERIAS —

TABLE—
EUCALYPTUS
BASE AND TOP
MHC.3 MISS CHAIR—
HEM CARPET—

TABLE WITH
CENTRAL TURNTABLE—
SUNRISE OAK
BASE AND TOP

TAVOLO—
BASAMENTO E PIANO
EUCALIPTO
SEDIA MHC.3 MISS—
TAPPETO HEM—

TAVOLO CON
PIATTO GIREVOLE—
BASAMENTO E PIANO
ROVERE SUNRISE



FILIGREE

RODOLFO DORDONI

Filigree is a range of fixed size and extendable tables. Diecast aluminium frames underpin tops enhanced by a wide range of finishes. The technological devices adopted play a key role with telescopic extension systems, thin reinforced tops and dedicated surface treatments for each type of material used. Fixed size rectangular and one extendable rectangular version enhance the design with functional features.

Filigree è una serie di tavoli fissi ed allungabili. Strutture in alluminio pressofuso si sposano con piani in diverse finiture. La tecnologia impiegata è protagonista discreta, con sistemi di allungamento telescopico, piani rinforzati a spessore ridotto, trattamenti delle superfici specifici per ogni tipo di materiale impiegato. Presenti versioni fisse, rettangolari e una versione allungabile rettangolare.



FILIGREE —

TABLE—
BLACK NICKEL STRUCTURE,
WHITE CARRARA MARBLE TOP
CHelsea CHAIRS—
GRAPHITE OAK,
QUINTEN CUPBOARDS—
PEWTER COLOUR PAINT
BASE, SIDES AND DOORS,
GRAPHITE OAK
TOP AND TRAYS
HEM CARPET—

TAVOLO—
STRUTTURA NICKEL NERO,
PIANO MARMO BIANCO CARRARA
SEDIE CHELSEA—
ROVERE GRAFITE,
MADIE QUINTEN—
BASAMENTO, SPALLE E ANTE
VERNICIATO PELTRO,
TOP E VASSOI
ROVERE GRAFITE
TAPPETO HEM—



FILIGREE —

TABLE—
EUCALYPTUS STRUCTURE,
EMPERADOR DARK MARBLE TOP
CHelsea CHAIRS—

TAVOLO—
STRUTTURA EUCLIPITO,
PIANO MARMO EMPERADOR DARK
SEDIE CHELSEA—



FILIGREE —

TABLE—
EUCALYPTUS STRUCTURE,
EMPERADOR DARK MARBLE TOP

STRUCTURE, BLACK NICKEL
WHITE CARRARA MARBLE TOP

STRUCTURE,
TOP

TAVOLO—
STRUTTURA EUCALIPTO,
PIANO MARMO EMPERADOR DARK

STRUTTURA, NICKEL NERO
PIANO MARMO BIANCO CARRARA

STRUTTURA,
PIANO



ARC

FOSTER + PARTNERS

A sculptural table, inspired by the technostructures. The table Arc embodies the innovative concepts which distinguish it. The base shape is inspired by the technostructures currently used in modern building: a new "light" cement which mixes colour and a special fibrous material obtaining resistant structures with a low specific weight. Arc is available with round and oval tops which come in glass or in marble.

Un tavolo scultura che ripropone le forme delle tensostrutture. Il tavolo Arc incorpora diversi concetti innovativi che lo distinguono. La forma del basamento si ispira alle tensostrutture spesso utilizzate nei moderni edifici, il materiale utilizzato: un nuovo cemento "leggero" che nel suo impasto incorpora, il colore ed uno speciale materiale fibroso che permette di ottenere strutture resistenti caratterizzate da un basso peso specifico. Arc è disponibile con piani rotondi e ovali in vetro o in marmo.





ARC —

TABLE—
WHITE BASE,
EXTRALIGHT GLASS TOP

TAVOLO—
BASAMENTO BIANCO,
PIANO VETRO EXTRACHIARO

TABLE—
BRICK RED CONCRETE BASE,
EXTRALIGHT GLASS TOP
BARBICAN CHAIR WITH ARMS—
EUCALYPTUS BASE,
NATURAL BONDED HIDE LEATHER—

TAVOLO—
BASAMENTO CEMENTO MATTONE,
PIANO VETRO EXTRACHIARO
SEDIA CON BRACCIOLI BARBICAN—
BASAMENTO EUCALIPTO,
CUOIO RIGENERATO NATURALE—



ARC —

TABLE—
BLACK BASE,
BLACK MARQUINA MARBLE TOP
OUTLINE CHAIRS—
SIRIA S1291 LEATHER
GRADUATE BOOKCASE—
SUPPORTING TOP-SHELF AND SHELVES
BLACK ALUMINIUM

TAVOLO—
BASAMENTO NERO,
PIANO MARMO NERO MARQUINA
SEDIE OUTLINE—
PELLE SIRIA S1291
LIBRERIA GRADUATE—
PIANO DI SOSTEGNO E RIPIANI
ALLUMINIO NERO



ARC —

OVAL TABLE—
GREY BASE,
EXTRALIGHT GLASS TOP
MONTECATINI D.235.1 CHAIRS—
POLISHED ALUMINIUM
PIROSCAFO BOOKCASE—
CHALK WHITE FRONT,
EUCALYPTUS STRUCTURE

TAVOLO OVALE—
BASAMENTO GRIGIO,
PIANO VETRO EXTRACHIARO
SEDIE MONTECATINI D.235.1—
ALLUMINIO LUCIDATO
LIBRERIA PIROSCAFO—
FACCIATA BIANCO CALCE,
STRUTTURA EUCALIPTO



DIAMOND

PATRICIA URQUIOLA

A range of tables with wrapped and folded feet like a delicate origami. The square or rectangular tops are available in glass or marble, the support structure is either shiny aluminium, matt or glossy lacquered (pewter colour and copper excluded), copper or pewter colour (metallic finishes).

Una serie di tavoli dalla gamba piegata e incartata come un delicato origami. I piani, quadrati o rettangolari, sono disponibili in vetro o marmo, da comporre con strutture di sostegno in alluminio lucido, laccato opaco o lucido (esclusi peltro e rame), rame o peltro (finiture metalliche).



DIAMOND —

TABLE—
PEWTER STRUCTURE,
GRAPHENE GLASS TOP
TEA CHAIRS—
BLACK OAK BASE
KYLE KG696
STRIPE CARPET—

TAVOLO—
STRUTTURA PELTRO,
PIANO VETRO GRAFENE
SEDIE TEA—
BASAMENTO ROVERE NERO
KYLE KG696
TAPPETO STRIPE—



DIAMOND —

TABLE—
COPPER STRUCTURE,
SAHARA NOIR MARBLE TOP
GLOVE-UP CHAIRS—

TAVOLO—
STRUTTURA RAME,
PIANO MARMO SAHARA NOIR
SEDIE GLOVE-UP—



DIAMOND —

TABLE—
PEWTER STRUCTURE,
SAHARA NOIR MARBLE TOP
GLOVE CHAIRS—
PAGLIA Z64PS FABRIC

TAVOLO—
STRUTTURA PELTRO,
PIANO MARMO SAHARA NOIR
SEDIE GLOVE—
TESSUTO PAGLIA Z64PS



WORK IS NOT PLAY, PLAY IS NOT WORK, NOT EVERYTHING CAN BE FORESEEN IN THE LIFE OF A HOME OR THE REQUIREMENTS OF ITS INHABITANTS. BUT TODAY THE TOOLS OF PLAY AND THOSE OF WORK, THOSE THAT INFORM AND THOSE THAT COMMUNICATE, ARE ONE AND THE SAME. NOT EVERYTHING CAN BE FORESEEN IN THE LIFE OF FURNITURE, BUT GOOD FURNITURE WILL ACCOMMODATE DIFFERENT OBJECTS AND INSTRUMENTS AND WILL ADAPT TO THE MATERIAL PROBLEMS AND THE SPIRIT OF THE HOME'S INHABITANTS.

IL LAVORO NON È UN GIOCO, IL GIOCO NON È UN LAVORO, NON TUTTO PUÒ ESSERE PREVISTO NELLA VITA DELLE CASE E NELLE ESIGENZE DELLE PERSONE. MA OGGI ACCADE CHE GLI STRUMENTI DEL GIOCO E QUELLI DEL LAVORO, QUELLI PER INFORMARSI E QUELLI PER COMUNICARE, SI IDENTIFICHINO E CONFONDANO. NON TUTTO PUÒ ESSERE PREVISTO NELLA VITA DI UN MOBILE, MA UN BUON MOBILE DEVE POTER ACCOGLIERE OGGETTI E STRUMENTI DIVERSI, DEVE POTERSI ADATTARE AI PROBLEMI MATERIALI E ALLO SPIRITO DI CHI ABITA LA CASA.

home
office

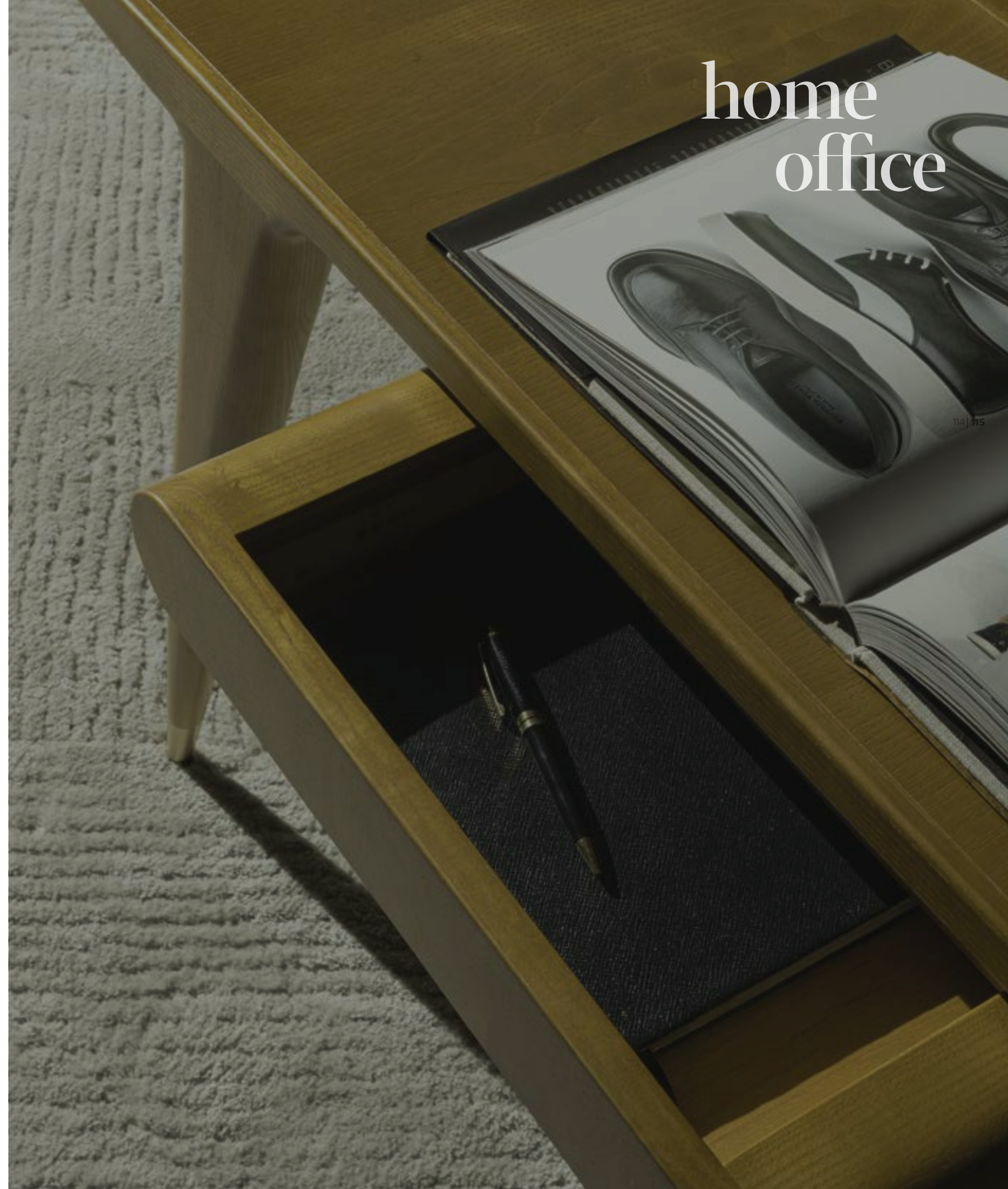

D.847.1

GIO PONTI

More than 70 years after its original design, the D.847.1 console table is reborn thanks to the Heritage Collection reissue project by Molteni&C, in collaboration with the Gio Ponti Archives. As with all the projects in the Heritage Collection, careful study of drawings, photos and period materials has made it possible to faithfully reproduce the D.847.1 desk in all its details, bringing back to life a masterpiece, inspired by the high level of craftsmanship in solid wood processing.

Dopo oltre 70 anni dal progetto originale, la consolle D.847.1 rinasce grazie al progetto di riedizioni Heritage Collection di Molteni&C, in collaborazione con i Gio Ponti Archives. Come per tutti i progetti della collezione Heritage, lo studio attento di disegni, foto e materiali d'epoca ha permesso di riprodurre fedelmente lo scrittoio D.847.1 in tutti i dettagli, riportando alla luce un capolavoro, dettato dall'alta artigianalità della lavorazione del massello.



HERITA-
GE COL-
LECTION





D.847.1—

WRITING DESK—
HONEY STAINED ASH
WOOD STRUCTURE,
SATIN BRASS FEET

SCRITTOIO—
STRUTTURA
FRASSINO TINTO MIELE,
PIEDI OTTONE SATINATO



TOUCH DOWN UNIT

STUDIO KLASS

Touch Down Unit, an innovative workstation designed by Studio Klass and originally thought for advanced work environments and produced by UniFor (a Molteni Group company), has become part of the Molteni&C collection in its new home version. TDU, enhanced by a series of new and more homely finishes, has been reinterpreted and conceived as an autonomous, discreet workstation. A safe place where to leave the necessary equipment to carry out your activity, may it be just sending an email or checking your schedule, thus becoming an object designed to meet individual requirements which changes and comes to life as a space for your personal items. The Touch Down Unit is discreet, autonomous and multitasking, allowing you to work from a chair, sofa, stool, or from a standing position, thus ensuring your physical wellbeing and adapting to any space.

Touch Down Unit l'innovativa workstation, design Studio Klass, pensata in origine per ambienti di lavoro evoluti e prodotta da UniFor (azienda del Gruppo Molteni), nella nuova versione home entra a far parte della collezione Molteni&C. TDU arricchito anche da una serie di nuove finiture più vicine al mondo della casa, viene riletto e pensato come una postazione intima, personale, un nido dove lasciare e ritrovare i propri strumenti per svolgere un certo tipo di attività, dal mandare una mail al consultare la propria agenda, diventando quindi un oggetto cucito sulla persona, mutando e prendendo vita insieme ai suoi oggetti ed effetti personali. Touch Down Unit è discreto, autonomo e multitasking, permette di lavorare da sedia, divano, sgabello, oppure stando in piedi garantendo così il benessere fisico e adattandosi ad ogni spazio.



TOUCH DOWN UNIT —

WORKSTATION—
AMERICAN WALNUT TOP
AND EXTERNAL SHELL BRONZE
LACQUER CENTRAL BODY
ARMCHAIRS—
WALTER
CHAIRS—
BARBICAN
CARPET—
LOO&CUT

POSTAZIONE DA LAVORO—
TOP NOCE CANALETTO CORPO
CENTRALE VERNICIATO BRONZO
FINITURA UNIFORME
POLTRONE—
WALTER
SEDIE—
BARBICAN
TAPPETO—
LOO&CUT





TOUCH DOWN UNIT —

TDU—
 SHELL AND WORKTOP IN UNIFOR
 AMERICAN WALNUT FINISH
 CENTRAL BODY PAINTED BRONZE
 BARBICAN—
 PAINTED PEWTER COLOUR FINISH BASE
 MUD GREEN BONDED HIDE
 LEATHER SHELL

TDU—
 GUSCIO E TOP NOCE CANALETTO
 FINITURA UNIFOR
 CORPO CENTRALE VERNICIATO BRONZO
 BARBICAN—
 BASAMENTO VERNICIATO
 PELTRO
 SCOCCA CUIOIO VERDE FANGO



NOTE

MATTEO NUNZIATI

This desk is the result of the desire to create a contemporary product with essential characteristics and very refined aesthetic and technical details that demonstrate the woodworking expertise that Molteni&C. is devoted to maintaining. The top, positioned asymmetrically on the structure, has two trays carved into its wood surface, and the central tray is covered in saddle leather. The wood on the rear is made with a pronounced curved shape that allows it to hold small drawers, which are also covered in saddle leather. The legs are made with a complex three-dimensional woodworking technique in which grooves are carved into three sides of the piece. The resulting product shows a good balance of essential style and elegance, simultaneously modern and linear while also refined and rich in expert cabinet-making details.

Il progetto nasce dalla volontà di creare un prodotto contemporaneo ma essenziale, molto ricercato nei dettagli estetici e tecnici, che esaltano tutta la maestria della lavorazione del legno tanto cara a Molteni&C. Il piano di scrittura, posizionato asimmetricamente, rispetto alla struttura, è dotato di due vassoi scavati direttamente nel piano stessi, di cui quello centrale ha un rivestimento in cuoio. La parte posteriore è caratterizzata da un pronunciata curvatura del legno che permette l'alloggiamento di piccoli cassetti rivestiti anch'essi in cuoio. Le gambe, realizzate grazie ad una complessa tecnica di lavorazione tridimensionale del legno, sono scavate su tre lati. Il risultato è un prodotto in equilibrio tra essenzialità ed eleganza, un prodotto moderno e lineare ma allo stesso tempo raffinato e ricco di dettagli di alta ebanisteria.





NOTE —

WRITING DESK—
AMERICAN WALNUT
STRUCTURE AND TOP,
DARK BROWN BONDED HIDE LEATHER
MHC.3 MISS CHAIR—
BLACK ASH,
L200 LEATHER

SCRITTOIO—
STRUTTURA E PIANO
NOCE CANALETTO,
CUOIO RIGENERATO TESTA DI MORO
SEDIA MHC.3 MISS—
FRASSINO NERO,
PELLE L200



SCRIBA

PATRICIA URQUIOLA

A writing desk with very clean lines and a decoratively perforated top support element that conveys a sense of lightness. Wood tops, a practical side drawer and a clever bookshelf support element in lacquered sheet metal complete the desk.

Uno scrittoio dalle nitide linee dove, l'elemento di sostegno del piano di scrittura, si caratterizza per la leggerezza data dal decoro traforato. Piani in legno, un pratico cassetto laterale e un ingegnoso supporto reggilibri in lamiera laccata completano lo scrittoio.



SCRIBA —

WRITING DESK—
EUCALYPTUS,
DOLOMITE GREY MATT LACQUER
MHC.3 MISS CHAIR—
BLACK ASH, L209 LEATHER
HEM CARPET—

SCRITTOIO—
EUCALIPTO,
LACCATO OPACO DOLOMITE
SEDA MHC.3 MISS—
FRASSINO NERO, PELLE L209
TAPPETO HEM—



LESSLESS

JEAN NOUVEL

LessLess is a complete range of tables, rectangular and square, lacquered in different colours. An aluminium structure the strength of which lies in a play on corners and folds. The external outline of the horizontal table top is very thin and stiffness and it is obtained by bending the aluminium sheet along inclined planes. Designed originally for the Fondation Cartier in Paris, the LessLess tables stand out for intrinsic elegance and light lines in every environment.

LessLess è una famiglia completa di tavoli, rettangolari e quadrati, laccati in diversi colori. Una struttura in alluminio, la cui resistenza è tutta affidata ad un gioco di spigoli e pieghe. Il profilo esterno del piano orizzontale è sottilissimo e la rigidità è ottenuta piegando la lamiera di alluminio secondo piani inclinati. Disegnati originariamente per la Fondation Cartier a Parigi, i tavoli LessLess rivelano la loro estrema eleganza e leggerezza in ogni ambiente.



LESSLESS —

TAVOLO—
CHALK WHITE MATT LACQUER
MONTECATINI D.235.1 CHAIR—
POLISHED ALUMINIUM

TAVOLO—
LACCATO OPACO BIANCO CALCE
SEDLA MONTECATINI D.235.1—
ALLUMINIO LUCIDATO



SITTING ROUND A TABLE IS A RITUAL,
AN EVERYDAY WAY OF COMING
TOGETHER. TABLES AND CHAIRS
PROVIDE THE BEATING HEART OF A
HOME AROUND WHICH FURNITURE
AND STORAGE UNITS, PLUS THEIR
CONTENTS, ARE ARRANGED.
CHAIRS ARE AWKWARD: THEY
HAVE TO SUPPORT BODYWEIGHT
WHILE TAKING SIZE, MOVEMENTS
AND POSTURE INTO ACCOUNT.
IT FOLLOWS THAT NOT ALL ITEMS
OF FURNITURE CAN MATCH IN
SHAPE OR STYLE BECAUSE THEY
HAVE TO SATISFY A VARIETY OF USES.

SEDERSI ATTORNO AD UN TAVOLO È UN ATTO RITUALE, PICCOLA CERIMONIA QUOTIDIANA DELL'INCONTRO. TAVOLO E SEDIA SONO IL NUCLEO GENERATORE DELLA CASA ATTORNO AL QUALE SI DISPONGONO MOBILI E CONTENITORI IN CUI RACCOGLIERE ORDINATAMENTE GLI OGGETTI E GLI STRUMENTI DI OGNI GIORNO. LA SEDIA È UN OGGETTO DIFFICILE: DEVE REGGERE IL PESO DEL CORPO TENENDO CONTO DELLE SUE FORME, DEI MOVIMENTI, DELLE POSTURE. PER QUESTO I MOBILI NON POSSONO OBBEDIRE A UNA SCELTA UNIVOCA DI FORMA O DI STILE, MA DEVONO CORRISPONDERE A TANTE POSSIBILITÀ DI IMPIEGO.

chairs



PORTA VOLTA

HERZOG & DE MEURON

The Porta Volta Chair by Herzog & de Meuron marks a new chapter of collaboration between the historic brand Molteni&C and the renowned international architectural firm, long-term partners of the Molteni Group. The Porta Volta Chair highlights the relationship between the upholstered seat and the solid timber back, the defining element of the design. The floating backrest extends around the perimeter of the seat in a U-shape, extending forward to create the armrests, and resting on 3 intersecting wooden U-frames that feature a special curved bent "finger joint" detail at their rounded corners. The structure is crafted from high-quality solid woods - Eucalyptus, black Oak, Sunrise Oak, graphite Oak or American walnut - ensuring exceptional durability and longevity. The thick padded seat, carefully rendered for the utmost comfort, is available in a wide range of fabrics, leather and in a special selection of Mohair velvet. The exclusive fabric collection is composed of 4 special custom-made colours: a bright sunflower yellow, a playful daisy pink, a deep royal blue and a silver grey. The chair has been imagined in two different sizes to allow for flexibility and a wider scope of use. The first is suited for dining - with a height of 71 cm, while the second, referred to as a low chair, is shorter at 66 cm and is intended for a living or a sitting room. One of the standout features of Porta Volta is the optional padding on the backrest, a rectangular-shaped element that latches onto the wooden beam, which is also available in a range of fabrics and leathers.

La sedia Porta Volta by Herzog & de Meuron segna un nuovo capitolo nella collaborazione tra lo storico brand Molteni&C e lo studio di architettura di fama internazionale, partner di lunga data del Gruppo Molteni. La sedia Porta Volta evidenzia il rapporto tra la seduta imbottita e lo schienale rigido, elemento principale del design. Lo schienale segue il perimetro della seduta a formare una U, spingendosi in avanti per creare i braccioli, mentre una giunzione a pettine, formata da tre elementi a forma di U intrecciati, lo collega al telaio sottostante e alle gambe. La struttura è realizzata con legno massello di alta qualità: eucalipto, rovere nero, rovere sunrise, rovere grafite e noce canaletto, per una durata e una resistenza eccezionali. La generosa imbottitura della seduta, appositamente studiata per regalare il massimo comfort, è disponibile in una vasta gamma di tessuti, pelli e una speciale selezione di velluto mohair. Sono 4 gli speciali colori su misura che vanno a comporre l'esclusiva collezione di tessuti: un vivace giallo girasole, un allegro rosa margherita, un intenso blu reale e un grigio argentato. La sedia è stata concepita in due diverse misure per una maggiore flessibilità e una più ampia destinazione d'uso. La prima versione, alta 71 cm, è adatta agli ambienti dining, mentre la seconda, ribattezzata "low chair", è pensata per il soggiorno o lo studio, essendo leggermente più bassa (66 cm). Su richiesta, la sedia Porta Volta può essere realizzata anche con lo schienale imbottito: alla fascia in legno si applica un apposito elemento rettangolare, disponibile anch'esso in una serie di tessuti e pelli.



PORTA VOLTA —

CHAIR—
BLACK OAK STRUCTURE,
SUNFLOWER YELLOW
MOHAIR VELVET
OLD FORD TABLE—
ARCHWAY SIDEBOARD—
EDGE CARPET—

SEDIA—
STRUTTURA ROVERE NERO,
VELLUTO MOHAIR
SUNFLOWER YELLOW
TAVOLO OLD FORD—
MADIA ARCHWAY—
TAPPETO EDGE—





PORTA VOLTA —

LOW CHAIRS—
SUNRISE OAK STRUCTURE,
WEB W6243 FABRIC
ATALANTE CARPET—

SEDIE LOW—
STRUTTURA ROVERE SUNRISE,
TESSUTO WEB W6243
TAPPETO ATALANTE—



PORTA VOLTA —

CHAIRS—
BLACK OAK STRUCTURE,
ZAGO Z1410 FABRIC
MATEO TABLE—
STRIPE CARPET—

SEDIE—
STRUTTURA ROVERE NERO,
TESSUTO ZAGO Z1410
TAVOLO MATEO—
TAPPETO STRIPE—



PORTA VOLTA —

CHAIR—
AMERICAN WALNUT
STRUCTURE,
ROYAL BLUE
MOHAIR VELVET
VIBRAZIONI CARPET—

SEDIA—
STRUTTURA
NOCE CANALETTO,
VELLUTO MOHAIR
ROYAL BLUE
TAPPETO VIBRAZIONI—

CHAIR—
BLACK OAK STRUCTURE,
UNIQUE UE199 LEATHER

SEDIA—
STRUTTURA ROVERE NERO,
PELLE UNIQUE UE199



JANET

VINCENT VAN DUYSSEN

Featuring clean and delicate lines, Janet is the latest design by creative director Vincent Van Duysen to join Molteni&C's rich collection of chairs. Janet is a chair with or without arms featuring a solid wood stained frame Eucalyptus, black Oak, Sunrise Oak and coffee Oak. Smart and sturdy, it gives a certain presence around a host of different tables. Its constituent parts are carefully and precisely rounded to create a harmonious whole. The frame, printed and made ergonomic by a thin layer of superior polyurethane, is hooked onto the two structure's crossbars, top and bottom. The result is an exceptionally comfortable integrated system of chair and back that develops seamlessly. Janet comes with textile or leather upholstery from the Molteni&C range.

Dalle linee pulite e delicate, Janet è il nuovo progetto del direttore creativo Vincent Van Duysen che si inserisce nella ricca proposta di sedute Molteni&C. Janet è una sedia con e senza bracciolo, la cui struttura in legno massello tinto Eucalipto, Rovere nero, Rovere Sunrise e Rovere caffè è solida e conferisce presenza a un oggetto che può accompagnarsi a una moltitudine di tavoli diversi. Gli elementi che costituiscono la struttura sono arrotondati grazie a una lavorazione del legno attenta e precisa che crea un tutt'uno armonico. La scocca, stampata e resa ergonomica da un sottile strato di poliuretano superiore, si aggancia alle due traverse, inferiore e superiore, della struttura. Il risultato è un sistema integrato di seduta e schienale che si sviluppa senza soluzione di continuità e dal comfort eccezionale. Janet è proposta con rivestimenti in tessuto o pelle nella gamma Molteni&C.





JANET —

CHAIRS—
EUCALYPTUS STRUCTURE
KIWI KH520 FABRIC

SEDIE—
STRUTTURA EUCA LIPTO
TESSUTO KIWI KH520



TEA

JASPER MORRISON

The Tea chair is a tribute to lightness. The structure, completely made of solid wood, outlines and reveals the profile of the chair in its entirety. With Tea, the London designer redefines the concept of seating in a contemporary way, adapting it to all types of furniture, with stability and practicality being of primary importance. Its lines blend elegance and ergonomics in complete harmony to create comfortable yet sophisticated seating. The seat and backrest are available in the entire Molteni&C textile and leather collection.

La sedia Tea è un omaggio alla leggerezza. La struttura, completamente in massello, delinea e lascia percepire il profilo della sedia nella sua totalità. Con Tea, il designer londinese ridefinisce il concetto di seduta in modo contemporaneo, adattandola a tutte le tipologie di arredo, dove la robustezza e la praticità d'uso sono di primaria importanza. Le linee di Tea si fondono in completa armonia fra eleganza ed ergonomia, al fine di ricreare delle sedute confortevoli e allo stesso tempo sofisticate. Il sedile e lo schienale si declinano in tutta la Collezione tessile e pelle di Molteni&C.





TEA —

CHAIRS—
BLACK OAK BASE,
UEI21 LEATHER
HALF A SQUARE TABLE—
ATALANTE CARPET—

SEDIE—
BASE ROVERE NERO,
PELLE UEI21
TAVOLO HALF A SQUARE—
TAPPETO ATALANTE



TEA —

CHAIRS—
BLACK OAK,
L 211 EXTRA LEATHER
DIAMOND TABLE—
GRADUATE BOOKCASE

SEDIE—
ROVERE NERO,
PELLE EXTRA L 211
TAVOLO DIAMOND—
LIBRERIA GRADUATE



DEVON

RODOLFO DORDONI

The Milanese designer Rodolfo Dordoni, also a master of trendy contemporary furnishings, has designed a collection of chairs suitable for any space and circumstance. Four chairs, two bucket armchairs, one bar stool with backrest and another without, these are the components of the Devon collection. All the frames are made of solid wood stained Eucalyptus, graphite Oak, black Oak, Sunrise Oak, coffee Oakveneers. Seats and backrests upholstered in fabric or leather chosen from the Molteni&C range. The strong feature of the solid wooden frame balances the fluid line of the backrests, blending ergonomics and elegance to create refined and comfortable chairs. Each element of the Devon collection expresses the value of craftsmanship, which is manifest in the way the top quality materials are processed, with details expressed with dedication and passion.

Rodolfo Dordoni, designer milanese, maestro dell'arredo contemporaneo di tendenza, disegna una collezione di sedute adatte ad ogni spazio e circostanza. Quattro sedie, due poltroncine a pozzetto, uno sgabello bar con supporto lombare e uno senza, sono gli elementi che compongono la collezione Devon. Tutte le strutture sono in massello tinto in essenza Eucalipto, Rovere grafite, Rovere nero, Rovere Sunrise, Rovere caffè. Sedute e schienali imbottiti in tessuto o pelle scelti tra la gamma Molteni&C. Il segno forte della struttura in massello bilancia la linea fluida degli schienali fondendo ergonomia ed eleganza per dare vita a sedute confortevoli e raffinate. Ogni singolo elemento della collezione Devon esprime il valore della maestria artigianale che trova evidenza nella lavorazione di materie prime di assoluta qualità con dettagli eseguiti con cura e passione.



DEVON —

DEVON CHAIRS—
BLACK OAK BASE,
EXTRA L162 LEATHER
VIBRAZIONI CARPET—

SEDIE DEVON—
BASAMENTO ROVERE NERO,
PELLE EXTRA L162
TAPPETO VIBRAZIONI—





DEVON —

DEVON—
WONDER WG447 COVER
BLACK OAK BASE
VIBRAZIONI CARPET—

DEVON—
RIVESTIMENTO WONDER WG447
BASAMENTO ROVERE NERO
TAPPETO VIBRAZIONI—



WOODY

FRANCESCO MEDA

This solid wooden chair made of two finishes, Natural Ash and Black Stained Ash, features harmoniously linked lines onto which the seat and backrest, both also made of wood or covered with bonded hide leather, are placed. The totally and seamlessly jointed, screw-free construction produces a lightweight, organic effect. Manual glueing with high tenacity glue. Plastic floor pads with kit of glides for different flooring types. The upholstery of the bonded hide leather version is not removable. The careful ergonomic study makes Woody comfortable, respecting the correct posture of the body.

Una solida struttura in legno massello in due varianti, Frassino Naturale e Frassino tinto nero, caratterizzata da linee armoniosamente raccordate su cui sono posizionati sedile e schienale anch'essi di legno oppure rivestiti in cuoio rigenerato. La soluzione costruttiva senza alcuna vite realizzata interamente ad incastri produce un'immagine unitaria e leggera. Incollaggio manuale con collanti ad alta tenacità. Appoggi a terra in materiale plastico con puntali in kit per le diverse pavimentazioni. Nella versione in cuoio rigenerato il prodotto non è sfoderabile. L'attento studio ergonomico rende Woody confortevole, rispettando la corretta postura del corpo.



WOODY —

CHAIRS—
ASH WOOD IN NATURAL COLOUR,
SEAT AND BACKREST
DOVE GREY BONDED HIDE LEATHER;
ASH WOOD STAINED BLACK,
SEAT AND BACKREST
BLACK BONDED HIDE LEATHER;
ASH WOOD IN NATURAL COLOUR;
ASH WOOD STAINED BLACK

SEDIE—
FRASSINO NATURALE,
SEDILE E SCHIENALE
CUOIO RIGENERATO TORTORA;
FRASSINO TINTO NERO,
SEDILE E SCHIENALE
CUOIO RIGENERATO NERO;
FRASSINO NATURALE;
FRASSINO TINTO NERO



BARBICAN

RODOLFO DORDONI

A series of comfortable chairs suitable for all sorts of settings. The design is based on a built-in padded seat, open or complete with armrests, the stiff polyurethane frame of which can be fully upholstered in textiles or leather, or alternatively the two materials that highlight the wrap-around shape of the chair. The seat can have three types of bases made of different materials such as wood or metal in two versions, making Barbican perfect for use in diverse contexts. The wooden base with linked curves is perfect for important tables. The metal base, with its modern design, is perfect both round a table and with home office desks or console tables. The tubular version is light and airy, ideal for contract projects where ruggedness and practicality are prime considerations. Barbican is a versatile design that redefines the chair in a contemporary style.

Una serie di comode sedie adatte a tutte le tipologie di arredo. Il progetto è basato sulla seduta imbottita integrata, aperta o dotata di braccioli, la cui scocca, in poliuretano rigido, può essere rivestita in tessuto o pelle, totalmente o utilizzando alternativamente i due materiali che ne evidenziano la forma avvolgente. Alla seduta è possibile abbinare tre tipi di basamenti composti da materiali differenti come legno o metallo in due versioni, rendendo Barbican perfetta per l'utilizzo in contesti diversi. Il basamento di legno con curve raccordate è perfetto per accostarsi a tavoli importanti. Quello in metallo, moderno nel progetto, è perfetto sia attorno ad un tavolo che con scrivanie o consolle dedicate all'home office. Quello tubulare è leggero ed aereo, adattissimo a realizzazioni contract dove la robustezza e la praticità d'uso sono di primaria importanza. Barbican è un progetto poliedrico che ridefinisce la sedia in modo contemporaneo.





BARBICAN —

CHAIRS—
BASE ALUMINIUM DIE-CAST
PEWTER COLOUR PAINT,
BACKREST SHELL
UNIQUE UE130 LEATHER,
SEAT SHELL—
EUCALYPTUS STRUCTURE AND TOP
SAFIRE FABRIC
PALETTE CARPET—

SEDIE—
BASAMENTO ALLUMINIO PRESSOFUSO
VERNICIATO PELTRO,
SCOCCA SCHIENALE
PELLE UNIQUE UE130,
SCOCCA SEDILE—
STRUTTURA E PIANO EUCALIPTO
TESSUTO SAFIRE
TAPPETO PALETTE—



BARBICAN —

CHAIR—
PEWTER COLOUR PAINT
METAL BASE,
UNIQUE UE195 LEATHER
BACKREST SHELL,
SUNNIVA 2 ZE591 FABRIC
SEAT SHELL

CHAIR WITH ARMS—
PEWTER COLOUR PAINT
METAL BASE,
SUNNIVA 2 ZE591 FABRIC
BACKREST SHELL AND
SEAT SHELL

SEDIA—
BASAMENTO METALLICO
VERNICIATO PELTRO,
SCOCCA SCHIENALE
PELLE UNIQUE UE195,
SCOCCA SEDILE
TESSUTO SUNNIVA 2 ZE591

SEDIA CON BRACCIOLI—
BASAMENTO METALLICO
VERNICIATO PELTRO,
SCOCCA SCHIENALE
E SCOCCA SEDILE
TESSUTO SUNNIVA 2 ZE591



D.235.1 MONTECATINI

GIO PONTI

Chair designed originally in 1938 for the first Palazzo Montecatini in Milan. This re edition is produced based on the original drawings from the Gio Ponti Archives. Entirely built from polished aluminium D.235.1.

Sedia disegnata originariamente nel 1938 per il primo Palazzo Montecatini di Milano. La riedizione è prodotta sulla base dei disegni originali custoditi nei Gio Ponti Archives. Realizzata completamente in alluminio lucidato D.235.1.



HERITA-
GE COL-
LECTION



D.235.1 MONTECATINI —

CHAIR—
POLISHED ALUMINIUM
TABLE—
CHALK WHITE MATT LACQUER

SEDIA —
ALLUMINIO LUCIDATO
TAVOLO—
LACCATO OPACO BIANCO CALCE



MHC.3 MISS

TOBIA SCARPA

The form is linked to a system of soft, unbroken, linear rhythms. The legs are slim and divaricated, to ensure stability. The front ones are bent to form the armrests and continue into the curve of the backrest. The back legs reach the backrest from behind, underpinning it. The seat is inserted between the lines and links them. Tobia Scarpa has re-designed the armrest joint to make the chair comfier and more linear. Structure in natural or black tinted ash, seat in leather, fabric or hand woven, ecru or grey, paper cord.

La forma è riportata a un sistema di ritmi di linee, con un segno morbido e continuo. Le gambe sono sottili e divaricate, per acquistare stabilità. Quelle anteriori si piegano a formare i braccioli e proseguono nella curva dello schienale. Le posteriori raggiungono lo schienale da dietro, per puntellarlo. Il sedile si inserisce tra le linee e le raccorda. Tobia Scarpa ha ridisegnato il giunto dei braccioli, per renderla più lineare e confortevole. Struttura in frassino naturale o tinto nero, seduta in pelle, tessuto o in corda intrecciata nei colori ecru e grigio.



HERITA-
GE COL-
LECTION



MHC.3 MISS —

CHAIRS—
BLACK
AND NATURAL ASH,
PAPER CORD
GREY AND ECRU COLOURS,
L200, L209 LEATHERS

SEDIE—
FRASSINO
NERO E NATURALE,
CORDA
COLORI GRIGIO E ECRÙ,
PELLI L200, L209





MHC.3 MISS —

CHAIR—
BLACK ASH,
PAPER CORD GREY COLOUR
HEM CARPET—

SEDIA—
FRASSINO NERO,
CORDA COLOR GRIGIO
TAPPETO HEM—

CHAIR—
BLACK ASH,
L209 LEATHER

SEDIA—
FRASSINO NERO,
PELLE L209



CHELSEA

RODOLFO DORDONI

The value of handcraftsmanship is expressed in the masterful use of high quality raw materials: wood, fabric and leather. Details were designed and applied with passion and care, which underscores the versatile nature and appeal of these pieces. Available with completely removable cover, for both fabric and leather versions. Wood finishes: Eucalyptus, Sunrise Oak, coffee Oak, graphite Oak, black Oak; silica, moka and black glossy lacquered finishes.

Tutto il valore di una maestria artigianale si esprime nella lavorazione di materie prime di assoluta qualità, dal legno al tessuto alla pelle, con particolari fatti con cura e passione che garantiscono il fascino a queste sedute estremamente versatili. Prodotto completamente sfoderabile sia nelle versioni in tessuto che in pelle. Finiture essenza: Eucalipto, Rovere Sunrise, Rovere caffè, Rovere grafite, Rovere nero; laccato lucido silice, moka e nero.



CHELSEA —

CHAIRS—
GRAPHITE OAK,
KUPIDO FABRIC
FILIGREE TABLE—
BLACK NICKEL STRUCTURE,
WHITE CARRARA MARBLE TOP
QUINTEN CUPBOARDS—
PEWTER COLOUR PAINT
BASE, SIDES AND DOORS,
GRAPHITE OAK
TOP AND TRAYS
HEM CARPET—

SEDIE—
ROVERE GRAFITE,
TESSUTO KUPIDO
TAVOLO FILIGREE—
STRUTTURA NICKEL NERO,
PIANO MARMO BIANCO CARRARA
MADIE QUINTEN—
BASAMENTO, SPALLE E ANTE
VERNICIATO PELTRO,
TOP E VASSOI
ROVERE GRAFITE
TAPPETO HEM—



CHELSEA —

CHAIRS—
BLACK OAK,
SAFIRE ZF613 FABRIC,
SIRIA S1222 LEATHER

SEDIE—
ROVERE NERO,
TESSUTO SAFIRE ZF613,
PELLE SIRIA S1222



GLOVE

PATRICIA URQUIOLA

A whole range of unconventional seating solutions: Sedute anticonvenzionali, pensate come aeree
flexible aerial surfaces at the service of comfort. superfici elastiche al servizio del comfort. Una
Glove, a technological structure coupled with struttura tecnologica accoppiata a strategiche
strategic padding, won the Chicago Athenaeum imbottiture, Glove ha vinto The Chicago Athenaeum
Good Design Award in 2007. Leather or fabric: Good Design Award 2007. Disponibile in pelle o
fluid shake and continuous profiles where the tessuto, è caratterizzata da forme fluide e profili
detail of a curve creates a silhouette without any continui, dove il dettaglio di una curva genera il
additions or accessories. disegno senza aggiunte o accessori.



GLOVE —

CHAIRS—
PAGLIA Z64PS FABRIC
DIAMOND TABLE—
BLACK MATT LACQUER STRUCTURE,
SAHARA NOIR MARBLE TOP

SEDIE—
TESSUTO PAGLIA Z64PS
TAVOLO DIAMOND—
STRUTTURA LACCATO OPACO NERO,
PIANO MARMO SAHARA NOIR



GLOVE-UP

PATRICIA URQUIOLA

Glove-Up is the evolution of a rigorous design theme, featuring sinuous, moulded and softly linked lines. A balance of forms which, from the fluid line of the backrest, flows into the lightness of the legs. An inviting chair or small armchair, upholstered in fabric or leather, make Glove-Up fun and versatile, suitable for any classic or contemporary setting.

Glove-Up rappresenta l'evoluzione di un tema progettuale rigoroso, caratterizzato da linee sinuose, plasmate e morbidamente raccordate. Un equilibrio di forme che, dalla linea fluida dello schienale, confluisce nella leggerezza delle gambe. Sedia o poltroncina dal comfort accattivante, rivestite in tessuto o pelle, rendono Glove-Up spiritosa e versatile, adatta ad ogni ambiente classico o contemporaneo.



OUTLINE

ARIK LEVY

Outline is the ideal companion for all tables due to the multitude of available versions: in full fabric or leather, or fabric and leather with metal legs. With Outline, comfort meets functionality over time, thanks to an ergonomic seat and multiple upholstery options.

Outline è la compagna ideale di tutti i tavoli grazie alla molteplicità delle versioni disponibili: totalmente in tessuto o pelle, in tessuto e pelle con gambe in metallo. Outline è la comodità abbinata alla funzionalità nel tempo, grazie ad una seduta ergonomica e ai molteplici rivestimenti.





OUTLINE —

CHAIR—
LUXOR L1610 LEATHER

SEDIA—
PELLE LUXOR L1610



ALFA

HANNES WETTSTEIN

Alfa was born from the union of just two pieces: one is the back, which continues into the rear legs; the other is the seat that extends into the front legs. Both pieces are in composite of polyester and resin, fibre-glass reinforced. Alfa can be matt lacquered.

Alfa nasce dall'accoppiamento di due soli pezzi: uno è lo schienale che prosegue nelle gambe posteriori; l'altro è la seduta che si prolunga nelle gambe anteriori. Entrambi i pezzi sono in composito di resine e poliestere rinforzato con fibra di vetro. Alfa viene realizzata verniciata opaca.





ALFA —

CHAIRS—
ANTHRACITE, CHALK
WHITE MATT COLOURS

CHAIRS—
ANTHRACITE MATT COLOUR
ARC TABLE—
WHITE BASE,
EXTRALIGHT GLASS TOP

SEDIE—
COLORI OPACHI,
ANTRACITE, BIANCO CALCE

SEDIE—
COLORE OPACO ANTRACITE
TAVOLO ARC—
BASAMENTO BIANCO,
PIANO VETRO EXTRACHIARO



FURNITURE IS ROOTED IN THE GREAT, POSITIVE, ARTISAN TRADITION AND YET, CONTINUITY, HISTORICAL REFERENCES AND MEMORY SIT UNEASILY WITH AN OPEN, INCLUSIVE, EXPERIMENTAL APPROACH THAT TRIES TO INCORPORATE NEW TECHNOLOGIES AND NEW SOLUTIONS. PROFILES BEVELS, JOINS, DIFFERENT MATERIALS ALL MAKE UP THE INHERENT POETRY OF PERFECTION AND DETAIL. MUCH OF THE BEAUTY OF FURNITURE LIE PRECISELY IN THIS PERFECTION.

I MOBILI HANNO RADICI IN UNA GRANDE E POSITIVA TRADIZIONE ARTIGIANALE: E TUTTAVIA, CONTINUITÀ, RIFERIMENTO E MEMORIA CONVIVONO IN DIFFICILE EQUILIBRIO CON UN ATTEGGIAMENTO SPERIMENTALE E APERTO, INCLUSIVO, CHE PROVA AD INCORPORARE NUOVE TECNOLOGIE E NUOVE SOLUZIONI. SAGOME, SMUSSI, ATTACCHI, PASSAGGI DI MATERIE, COSTITUISCONO DALL'INTERNO UNA POETICA DELLA PERFEZIONE E DEL DETTAGLIO. IN QUESTA PERFEZIONE STA MOLTA DELLA BELLEZZA DEI MOBILI.

single units
and bookcases

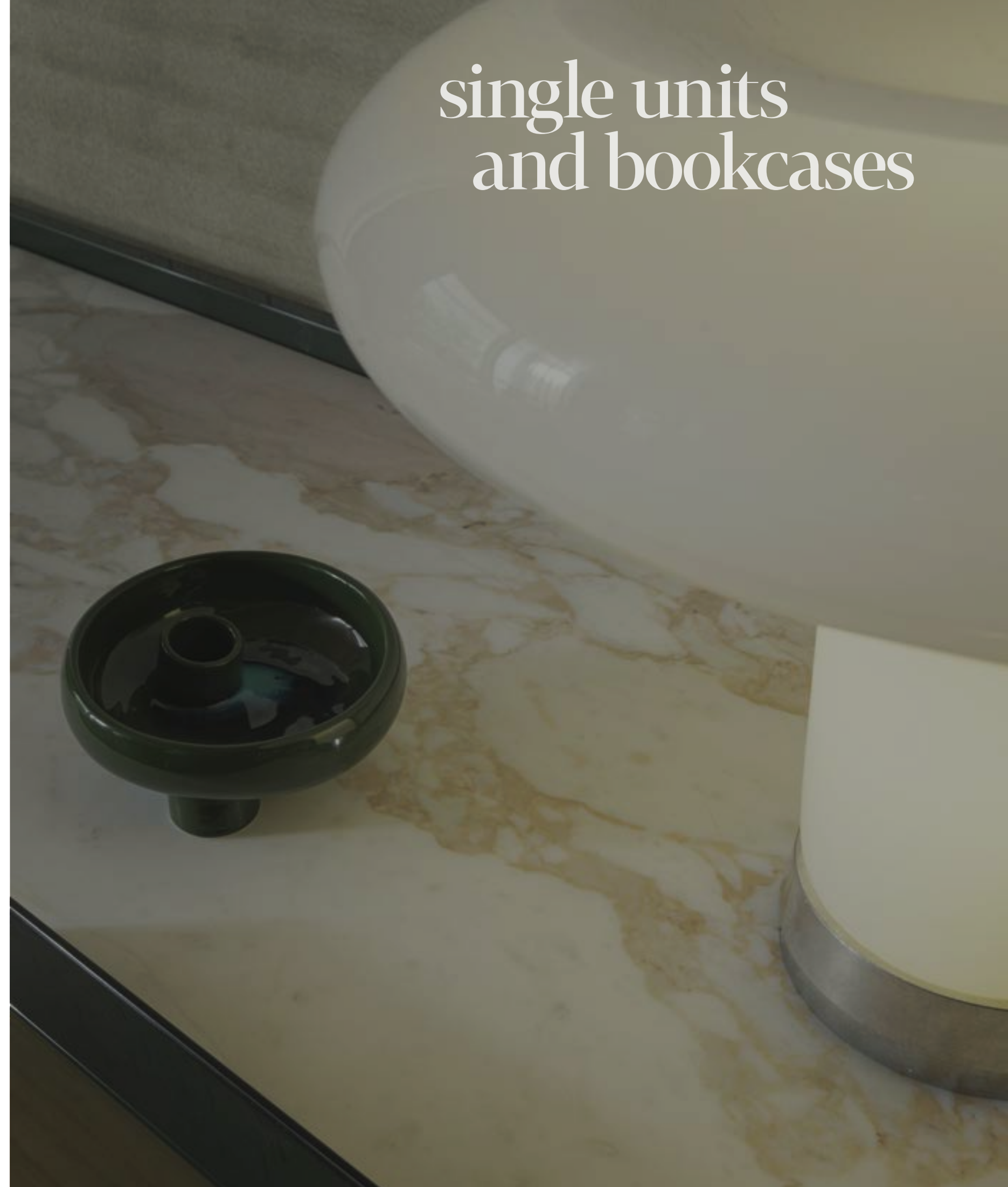

ARCHWAY

RODOLFO DORDONI

Archway owes its striking form to its stylish and modern silhouette. The sideboard's door is embellished with a slightly cantilevered metal profile with respect to the top, which traces the handle with a rigorous line. In the centre, an open compartment with a drawer provides a central volume, creating a sense of movement. Archway is available in two lengths, 242 and 270 cm, while the plinth is 18 cm in height and hides an integrated drawer, allowing for added versatility within the design. Beautifully finished on both sides, it can be placed against a wall or in the centre of a room as a dividing element. The sideboard can be customised in all the glossy lacquered shades available in the Molteni&C catalogue, including the new pine green and almond white colours, allowing for infinite possibilities to easily be combined with any interior palette. The top, in contrast with the structure, is available in wood or marble. Among the essences are the gold-toned limba and the coffee oak, recognisable for its intense contrasting streaks. The marble proposal ranges from calacatta, sahara noir to black marquina in matte or glossy polyester versions, offering a wide range of options to customise the aesthetic. The integrated handles are the epitome of attention to detail: cut at a 45-degree angle, they give a unique and precious look. The interior shelves can be in wood or smoked glass. The versatile Archway is perfect for the dining or living area.

La struttura colpisce per un nuovo concetto compositivo caratterizzato da una silhouette elegante e dal sapore moderno. L'anta è impreziosita da un profilo metallico leggermente a sbalzo rispetto al top, per determinare, con un tratto rigoroso, la maniglia. Al centro un vano a giorno corredato da un cassetto, che fornisce un volume centrale cavo che conferisce movimento. Archway è disponibile in due lunghezze, 242 cm e 270 cm ed è caratterizzata da una base di 18 cm di altezza, che nasconde al suo interno un pratico cassetto, consentendone maggiore versatilità. Splendidamente rifinita su entrambe i lati, può essere posizionata contro una parete o al centro di una stanza come elemento divisorio. La madia è personalizzabile nelle tonalità laccate lucide disponibili a catalogo, tra le quali i nuovi pine green e almond white, consentendo infinite possibilità di caratterizzazione, per abbinarla con facilità ad ogni interno. Il piano, in contrasto rispetto alla struttura, è disponibile in essenza o in marmo. Tra le essenze vengono annoverate il limba con i suoi toni dorati o il rovere caffè, dalle screziature intense. La proposta dei marmi spazia tra il calacatta, il sahara noir e il nero marquina in versione opaco o poliestere lucido, offrendo un'ampia gamma di opzioni per personalizzarne l'estetica. Le gole delle ante rappresentano l'emblema della cura al dettaglio: tagliate con un angolo di 45 gradi, conferiscono un aspetto unico e prezioso. Le mensole interne possono essere in essenza o vetro fumé. La madia Archway è perfetta per la zona pranzo o per il soggiorno, grazie alla sua versatilità di utilizzo.



ARCHWAY —

SIDEBOARD—
LONDON SKY
GLOSSY LACQUER
STRUCTURE AND DOORS,
LIMBA DRAWERS AND TOP

MADIA—
STRUTTURA E ANTE
LACCATO LUCIDO
LONDON SKY,
CASSETTI E TOP LIMBA







ARCHWAY —

SIDEBOARD—
PINE GREEN
GLOSSY LACQUER
STRUCTURE AND DOORS,
LIMBA DRAWERS,
CALACATTA MARBLE
TOP AND OPEN COMPARTMENT

MADIA—
STRUTTURA E ANTE
LACCATO LUCIDO
PINE GREEN,
CASSETTI LIMBA,
TOP E VANO A GIORNO
MARMO CALACATTA



LIVING BOX

VINCENT VAN DUYSSEN

Living Box was conceived as an independent item of furniture, usable in any room of the house, but mainly suitable for the living room. Despite its reduced size, it retains the rigour and monumentality of the building it derives from, accentuating its details by means of quality materials. Living Box is a low, but large (230, 280, 330, 380) doorless rectangular container, in which the outside and inside contrast with each other via the use of different materials. The top features marble and different woods, specially arranged to decorate the surface. The whole is enclosed within an iris and pewter frame, thread-like if seen from above, but forming a thick profile surrounding the inside space if seen from the front. The top can be fitted and integrated with trunking, useful for facilitating connections of any kind between multimedia equipment, TVs or lighting equipment. The rest of the top can be left free or used to display artistic or personal ornaments. Suffused lighting is provided by Leds. The inside space is completely free and devoid of sharp corners thanks to special curved corner-covers. The space created in this way allows any type of object to be displayed at will. If this scenographic solution does not fit the purpose, one or more sober and elegant sets of drawers can be added, with an iris and pewter, or a wood finish and featuring a sober and elegant design. These occupy the free space, concealing what is useful but preferably not visible.

Living Box è un contenitore rettangolare, basso, di grandi dimensioni (230, 280, 330, 380) e privo di ante, in cui esterno ed interno si contrappongono attraverso l'utilizzo di materiali diversi. L'esterno è caratterizzato da una grande superficie d'appoggio, dove marmi ed essenze sono utilizzate per decorarne il piano tramite particolari disposizioni geometriche dei materiali impiegati. Il tutto è racchiuso in una cornice, in iris e peltro, all'apparenza filiforme se vista dall'alto, ma che vista di fronte si trasforma in un vero e proprio profilo a forte spessore che contorna il vano interno. Il piano può essere predisposto e integrato con passacavi, utili a facilitare i collegamenti di qualsiasi genere tra apparecchiature multimediali, TV o apparecchi di illuminazione. Il rimanente spazio di appoggio può restare libero o essere utilizzato per appoggiare oggetti artistici o di affezione. La luce a Led lo illumina in modo soffuso. Lo spazio interno è completamente libero e privo di angoli acuti grazie a speciali copri-angoli curvi. Lo spazio così creato è disponibile ad accogliere qualsiasi tipo di oggetto che si voglia appoggiare e mostrare. Se questa soluzione scenografica risultasse all'apparenza non funzionale è possibile aggiungere una o più cassettiere, con finitura iris e peltro o in essenza, dal disegno sobrio ed elegante che vanno a popolare lo spazio libero nascondendo ciò che è utile ma si preferisce non rivelare.



LIVING BOX —

CUPBOARD—
SUNRISE OAK STRUCTURE—
BRECCIA CAPRAIA MARBLE
TOP IRIS TOP FRAME
DRAWERS—
IRIS

MADIA—
STRUTTURA ROVERE SUNRISE—
TOP MARMO BRECCIA CAPRAIA
CORNICE TOP IRIS
CASSETTI—
IRIS



LIVING BOX —

CUPBOARD—
SUNRISE OAK STRUCTURE AND TOP—
PEWTER COLOUR TOP
FRAME DRAWERS—
PEWTER COLOUR

MADIA—
STRUTTURA E TOP ROVERE SUNRISE—
CORNICE TOP PELTRO
CASSETTI—
PELTRO





LIVING BOX —

CUPBOARD—
SUNRISE OAK STRUCTURE AND TOP
PEWTER COLOUR TOP
FRAME DRAWERS—
PEWTER COLOUR

MADIA—
STRUTTURA E TOP ROVERE SUNRISE—
CORNICE TOP PELTRO
CASSETTI—
PELTRO



LIVING BOX —

CUPBOARD—
EUCALYPTUS STRUCTURE
SAHARA NOIR TOP
IRIS FRAME TOP DRAWERS—
EUCALYPTUS IRIS PROFILE

MADIA—
STRUTTURA EUCALIPTO
TOP SAHARA NOIR CORNICE
TOP IRIS CASSETTI—
EUCALIPTO PROFILO IRIS





LIVING BOX —

CUPBOARD—
EUCALYPTUS STRUCTURE—
SAHARA NOIR TOP
IRIS FRAME TOP DRAWERS—
EUCALYPTUS IRIS PROFILE

MADIA—
STRUTTURA EUCA LIPTO
TOP SAHARA NOIR CORNICE
TOP IRIS CASSETTI—
EUCA LIPTO PROFILO IRIS



LIVING BOX —

CUPBOARD—
EUCALYPTUS STRUCTURE AND TOP—
PEWTER COLOUR FRAME
TOP DRAWERS—
PEWTER COLOUR

MADIA—
STRUTTURA E TOP EUCALIPTO
CORNICE TOP PELTRO
CASSETTI—
PELTRO



LIVING BOX —

LIVING BOX—
EUCALYPTUS STRUCTURE—
EMPERADOR DARK TOP
PEWTER FRAME TOP
DRAWERS—
EUCALYPTUS PEWTER COLOUR PROFILE

LIVING BOX—
STRUTTURA EUCALIPTO
TOP EMPERADOR DARK
CORNICE TOP PELTRO
CASSETTI—
EUCALIPTO PROFILO PELTRO



HORIZONS

DANTE BONUCCELLI

With Horizons, a cupboard for the daytime area, Dante Bonuccelli proposes a different way of storing, and at the same time displaying muchloved objects. Two tip-up doors, which, when closed, reveal the contents thanks to both the transparent stopsol glass and the internal LED lighting, and when open, folded back against the side of the piece for full access to the internal space, transform the cupboard like a chameleon. Inside the exquisitely detailed graphite Oak or coffee Oak structure, the two suspended drawers and the top shelf, which re-divides the space, are enhanced with calacatta marble or Sahara noir. The pewter colour framed and transparent stopsol glass doors are available with or without the graphite Oak or coffee Oak cross pieces. The former feature asymmetrically placed horizontal profiles, reminiscent of a shed that only partially reveals the inside, increasing curiosity about its contents. Designed as a cupboard for the dining area, thanks also to useful accessories such as the cutlery holder and the Eco Skin drawer bottom, or as a vitrine for precious objects.

Dante Bonuccelli con Horizons, mobile contenitore per l'area giorno, propone un diverso modo di contenere e nel contempo mostrare oggetti di affezione. Due ante basculanti, che chiuse rivelano il contenuto grazie al vetro stopsol trasparente e alla illuminazione interna LED, o aperte, ripiegate e affiancate alla struttura laterale per un accesso totale allo spazio interno, danno vita ad un oggetto che si trasforma "camaleonticamente". All'interno della struttura in Rovere grafite o Rovere caffè, dettagli preziosi, i due cassetti sospesi e la mensola superiore che ridivide lo spazio, arricchiscono questo prodotto gli schienali in marmo calacatta o Sahara noir. Le ante nella sua cornice petro e vetro stopsol trasparente, sono disponibili con e senza traversini rivestiti in Rovere grafite o Rovere caffè. Le prime si connotano per i profili orizzontali posti asimmetricamente, quasi a dar vita ad uno "shed" che mostra solo parzialmente l'interno, aumentando la curiosità per il suo contenuto. Pensato come madia per la zona dining, grazie anche agli utili accessori come porta posate e il fondo dei cassetti in Eco Skin, oppure come contenitore vetrina per oggetti di pregio.



ADRIEN

VINCENT VAN DUYSSEN

Adrien expresses a desire to present a new series of storage units, conceptually avantgarde both in technological and in aesthetic terms. Adrien is a fortunate combination of purity of form and exclusive materials and technologies, blended harmoniously and with a focus on key visual and tactile aspects. In Adrien the structural aluminium thickness is reduced to a minimum, allowing the Stopsol glass and the built-in LED lighting system of the shelves to enhance the appeal of the objects displayed. The back panel can be made of wood or glass to highlight the complete transparency of the object.

Adrien nasce dalla volontà di presentare una nuova serie di madie concettualmente all'avanguardia sia tecnologicamente che sotto il profilo estetico. Adrien rappresenta una felice combinazione tra purezza delle forme, uso di materiali e tecnologie esclusive che si compongono armoniosamente dove l'aspetto visivo e tattile riveste grande importanza. In Adrien si riduce al minimo lo spessore strutturale in alluminio, lasciando che il Vetro Stopsol e il sistema di illuminazione a LED integrato nei ripiani, valorizzi al massimo gli oggetti esposti. Lo schienale può essere in essenza o vetro per dare la completa trasparenza all'oggetto.



ADRIEN —

CUPBOARD—
EUCALYPTUS,
PEWTER FINISH GLASS
DOOR FRAME,
TRANSPARENT STOPSOL GLASS,
LED LIGHTING BARS
RANDOM CARPET—

MADIA—
EUCALIPTO,
TELAIO ANTE VETRO
PELTRO,
VETRO STOPSOL TRASPARENTE,
BARRE ILLUMINANTI A LED
TAPPETO RANDOM—





ADRIEN —

CUPBOARD—
EUCALYPTUS,
EMPERADOR DARK MARBLE TOP,
PEWTER FINISH GLASS
DOOR FRAME,
TRANSPARENT STOPSOL GLASS,
LED LIGHTING BARS

MADIA—
EUCALIPTO,
TOP MARMO EMPERADOR DARK,
TELAIO ANTE VETRO
PELTRO,
VETRO STOPSOL TRASPARENTE,
BARRE ILLUMINANTI A LED



AVA

FOSTER + PARTNERS

The design, featuring a single V-shaped profile, is used here both for the framework and for the bookshelves. As always, the use of innovative technological materials is what defines this project. Structural shelves made of plywood panels, reinforced with aluminium and then folded. The addition of a structural composite material profile, obtained via a process of extrusion by means of traction, allows for maximum load resistance. The design includes LED lamps, housed within the shelves. The outer finish is Eucalyptus wood. The back panel is made of a special aluminium sheet featuring a three-dimensional texture achieved with a laser cutter.

Il disegno di un unico profilo a V viene qui utilizzato sia per la struttura che per i ripiani della libreria. Come sempre, l'uso di materiali tecnologici innovativi connota questo progetto. Ripiani strutturali composti da pannelli in multistrato, rinforzati con alluminio e modellati a folding. L'aggiunta di un profilo in materiale composito strutturale, ricavato attraverso un processo di estrusione per trazione, permette di ottenere la massima resistenza ai carichi. Il progetto prevede, alloggiato all'interno dei ripiani, luci a led. La finitura esterna è in essenza di Eucalipto. Lo schienale è realizzato attraverso l'uso di una particolare lamiera in alluminio caratterizzata da una texture tridimensionale ottenuta tramite taglio laser.



AVA —

BOOKCASE—
EUCALYPTUS WITH
METAL BACK
PAINTED BRONZE
LED LIGHTING BARS
EDGE CARPET—

LIBRERIA—
EUCALIPTO CON
SCHIENALE METALLICO
VERNICIATO BRONZO,
BARRE ILLUMINANTI A LED
TAPPETO EDGE—



TEOREMA

RON GILAD

A unit with open compartments or drawers used as a single unit or stacked in a linear or offset mode, to create night tables, chests of drawers or modular systems for the living area. The construction is a perfect fusion of precision mechanical working and artisanal skills in the folding and gluing of the piece.

Elemento singolo o composto sovrapponendo vari elementi per dare vita a comodini, cassettiere, composizioni per la zona living lineari o disassate. La realizzazione è il perfetto connubio tra la precisione centesimale della lavorazione meccanica e la sapienza artigianale nella piegatura e nell'incollaggio della struttura.





TEOREMA —

DRAWER UNIT—
SPIRAL COMPOSITION
AMERICAN WALNUT,
SHINY CHROME HANDLE

CONTENITORE—
COMPOSIZIONE A SPIRALE
NOCE CANALETTO,
MANIGLIA CROMO LUCIDO



D.355.1 D.355.2

GIO PONTI

An object that the great Milanese architect was to re-design several times over the years, re-fashioned in the version for his via Dezza house in Milan, elmwood, hand-painted white, 240 or 195 cm long, with two partitions.

Un oggetto che il grande architetto milanese ridisegna più volte nel corso degli anni, rieditato nella versione per la sua casa di via Dezza a Milano, finitura in olmo, verniciato bianco a mano, 240 o 195 cm di lunghezza, con due divisori.



HERITA-
GE COL-
LECTION



D.355.1 —

SUSPENDED BOOKCASES—
ELM,
WHITE HAND-PAINTED
D.154.2 ARMCHAIRS—
JAN COFFEE TABLES—
HEM CARPET—

LIBRERIE SOPPESE—
OLMO,
VERNICIATO A MANO BIANCO
POLTRONE D.154.2—
TAVOLINI JAN—
TAPPETO HEM—



D.357.1 D.357.2

GIO PONTI

Designed in 1956-1957, the bookcase is part of the furniture of Gio Ponti's private house in via Dezza in Milan. This re edition is produced based on the original drawings from the Gio Ponti Archives. Made from shaped multi-layered material with elm veneer, partly with natural transparent finish, partly hand-painted in white. Available in the versions with or without applied mirror.

Disegnata tra il 1956 e il 1957, la libreria fa parte degli arredi dell'abitazione privata di Gio Ponti in via Dezza a Milano. La riedizione è prodotta sulla base dei disegni originali custoditi nei Gio Ponti Archives. Realizzata in multistrato sagomato con rivestimento in olmo, in parte con finitura trasparente naturale, in parte verniciato a mano in colore bianco. È disponibile nella versione con o senza specchiera applicata.



HERITA-
GE COL-
LECTION





D.357.1 —

BOOKCASE—
ELM,
WHITE HAND-PAINTED
D.154.2 ARMCHAIR—
PANNA COTTA COFFEE TABLE—

LIBRERIA—
OLMO,
VERNICIATO A MANO BIANCO
POLTRONA D.154.2—
TAVOLINO PANNA COTTA—



D.655.1 D.655.2

GIO PONTI

Chest of drawers designed in several versions in the period from 1952 to 1955. This re edition is produced based on the original drawings from the Gio Ponti Archives. Marked by hand-painted white drawer fronts with applied handles in various wood kinds (elm, italian walnut, mahogany and rosewood). The elmwood frame rests on satin brass feet.

Comò disegnato in diverse varianti tra il 1952 e il 1955. La riedizione è prodotta sulla base dei disegni originali custoditi nei Gio Ponti Archives. È caratterizzato dai frontali dei cassetti verniciati a mano in colore bianco con maniglie applicate di varie essenze (olmo, noce nazionale, mogano e palissandro). La struttura in essenza di olmo è sostenuta da piedi in ottone satinato.



HERITA-
GE COL-
LECTION



CHEST OF DRAWERS—
ELM, ITALIAN WALNUT,
MAHOGANY, ROSEWOOD,
WHITE HAND-PAINTED,
SATIN BRASS
D.153.1 ARMCHAIR—

D.655.1 —

CASSETTONE—
OLMO, NOCE NAZIONALE,
MOGANO, PALISSANDRO,
VERNICIATO A MANO BIANCO,
OTTONE SATINATO
POLTRONA D.153.1—

MHC.1

WERNER BLASER

MHC.1 is a new edition of the prototype of the first modern piece of furniture made by Molteni&C, the chest of drawers designed by Werner Blaser. Thought it was never produced industrially, in 1955 it won first prize at the Cantù "Prima mostra selettiva - Concorso internazionale del mobile", a competition designed to re-qualify the image of Italian furniture making. The jury was made up of Gio Ponti, Alvar Alto, Romano Barocchi, Carlo de Carli and Finn Juhl. The unusual joinery features a simple three-fork joint. After issuing a limited edition run of 100 numbered pieces, two new non-numbered versions are available in the new finishes honey stained pattern wood and black ash wood.

MHC.1 è una riedizione del prototipo del primo mobile moderno realizzato da Molteni&C, il cassettone disegnato da Werner Blaser. Mai entrato in produzione, vince il primo premio al concorso internazionale di Cantù del 1955, la 1° Selettiva, indetto per riqualificare l'immagine produttiva italiana. La giuria è composta da Gio Ponti, Alvar Alto, Romano Barocchi, Carlo de Carli e Finn Juhl. Particolare il sistema costruttivo basato sulla giunzione semplice a triplice forcella. Dopo una prima riedizione limitata di 100 pezzi numerati, è ora disponibile in due nuove versioni non numerate nelle inedite finiture emien tinto miele e frassino tinto nero.



HERITA-
GE COL-
LECTION



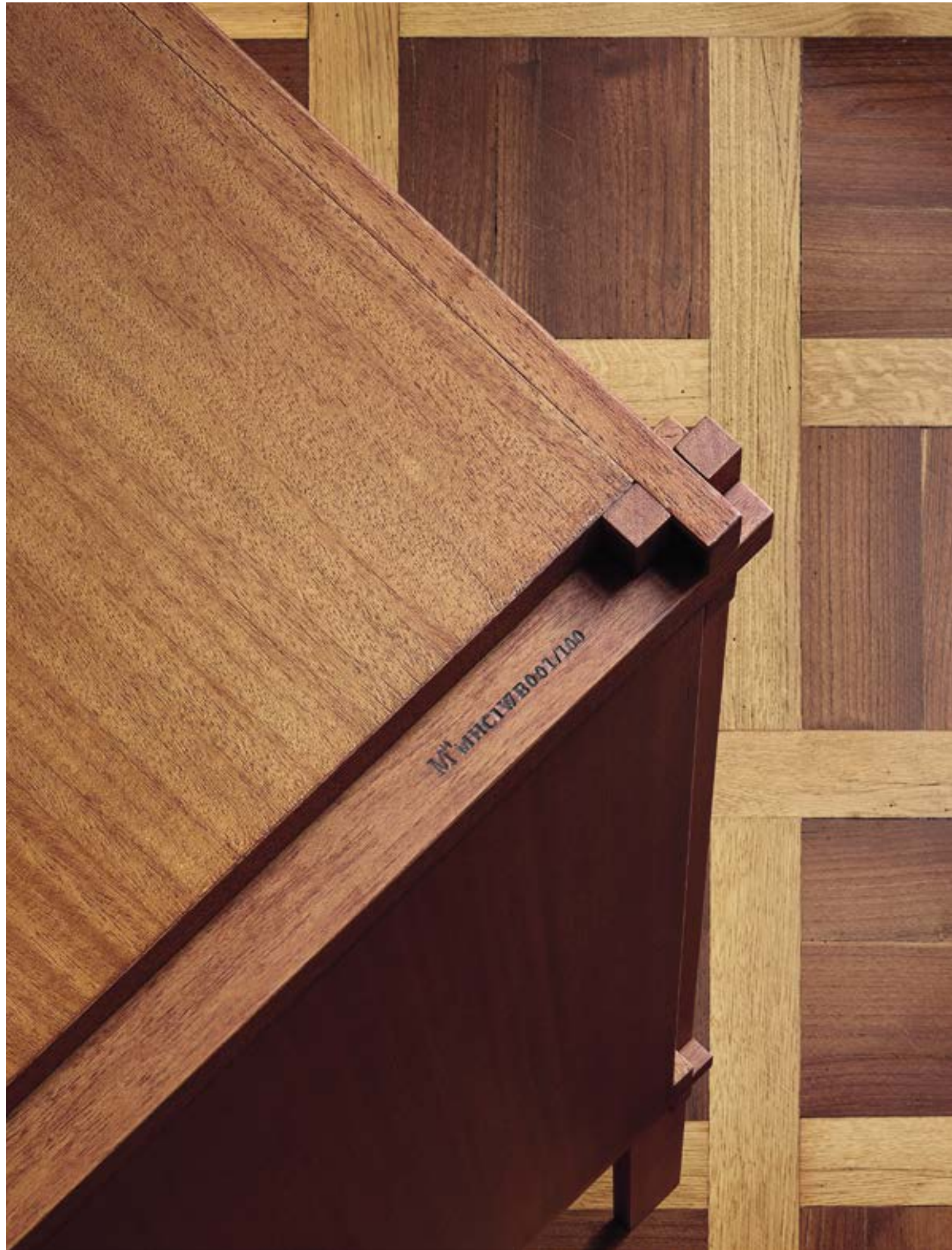

MHC.1 —

CHEST OF DRAWERS—
HONEY STAINED PATTERN WOOD

CASSETTIERA—
EMIEN TINTO MIELE



MHC.2

YASUHIKO ITOH

MHC.2 is a re-edition of the bookcase prototype designed in 1959 by Yasuhiko Itoh. Made in curved wood, a complex process for that time period, it won an award at the 3rd edition of the Selettiva competition in Cantù del 1959. This piece is both elegant and refined. After issuing a limited edition run of 100 numbered pieces, this item is now available as a standard, non-numbered piece in curved wood covered in walnut.

MHC.2 è una riedizione del prototipo della libreria disegnata nel 1959 da Yasuhiko Itoh. Realizzata in legno curvato, lavorazione complessa per l'epoca, fu premiata alla 3° edizione della Selettiva di Cantù del 1959. Il risultato è un pezzo elegante e raffinato. Dopo una prima riedizione limitata di 100 pezzi numerati, è ora disponibile in serie non numerata in legno curvato rivestito in noce.



MHC.2 —

BOOKCASE—
CURVED WOOD WITH
AMERICAN
WALNUT FINISH

LIBRERIA—
LEGNO CURVATO
RIVESTITO
DI NOCE CANALETTO



QUINTEN

VINCENT VAN DUYSSEN

Perfectly proportioned cupboards, an attentive choice of materials and treatments such as matt laquered woods and, in the new finishes, copper or pewter, as well as attention to the individual details ensure that every single item of furniture is a piece of refined beauty, where lines and volumes blend harmoniously.





QUINTEN —

CUPBOARDS—
 PEWTER COLOUR PAINT
 BASE, SIDES AND DOORS,
 GRAPHITE OAK
 TOP AND TRAYS
 LESSLESS TABLE—
 BLACK MATT LACQUER
 RANDOM CARPET—

MADIE—
 BASAMENTO, SPALLE E ANTE
 VERNICIATO PELTRO,
 TOP E VASSOI
 ROVERE GRAFITE
 TAVOLO LESSLESS—
 LACCATO OPACO NERO
 TAPPETO RANDOM—



45°/VETRINA

RON GILAD

A showcase designed to display and contain precious objects and books. Geometrically rotating surfaces that create 45° smoothed edges achieved by using a metal joint onto which aluminium profiles are hooked, veneered with precious wood types. The opening is totally invisible with the exception of a small key on the lateral profile. The result is a transparent solid that invites the gaze to linger on its contents.

Un mobile vetrato pensato per esporre e custodire oggetti e libri di pregio. Rotazione geometrica dei piani che portano ad angoli smussati a 45° risolti grazie all'impiego di un giunto metallico su cui vengono agganciati profili in alluminio, impiallacciati con essenze pregiate. L'apertura è totalmente invisibile eccetto per una piccola chiave posta sul profilo laterale. Il risultato è un solido trasparente che invita a guardare ciò che in esso viene custodito.



45°/VETRINA —

SHOWCASE—
AMERICAN WALNUT

VETRINA—
NOCE CANALETTO



GRADUATE

JEAN NOUVEL

Jean Nouvel has designed a brilliant wall structure resolved in a single shelf anchored to the wall or the ceiling. Slender steel braces support adjustable shelves in wood and aluminium that seem to float in the air thanks to invisible support mechanisms. Transparency and lightness in space made up of air.

Jean Nouvel ha disegnato una virtuosistica struttura sospesa, risolta da un'unica mensola ancorata a parete o a soffitto. Esili tiranti in acciaio reggono i ripiani regolabili in legno e alluminio, che paiono galleggiare nel vuoto grazie a invisibili meccanismi di sostegno. La leggerezza della trasparenza in un volume fatto di aria.



GRADUATE —

BOOKCASE—
BLACK ALUMINIUM SHELVES
STAINLESS STEEL TIE RODS
MARGOU ARMCHAIRS—
MARTEEN SEATING SYSTEMS—

LIBRERIA—
RIPIANI IN ALLUMINIO NERO
TIRANTI IN ACCIAIO INOX
POLTRONE MARGOU—
SISTEMA DI SEDUTE MARTEEN—



GRADUATE —

BOOKCASE—
SUPPORTING TOP-SHELF AND SHELVES
NATURAL ALUMINIUM
GLOVE CHAIR—
SIRIA S1211 LEATHER
DOMINO POUF—

LIBRERIA—
PIANO DI SOSTEGNO E RIPIANI
ALLUMINIO NATURALE
SEDIA GLOVE—
PELLE SIRIA S1211
POUF DOMINO—



PIROSCAFO

ALDO ROSSI, LUCA MEDA

Aldo Rossi and Luca Meda have designed a piece of architecture; a large facade featuring regularly spaced windows and inspired by the Regione Umbria headquarter's facade in Perugia. A bookcase with glass front and Eucalyptus wood or lacquered structure and a metal front matt lacquered. Piroascafo is a versatile home cupboard - a bookcase for the study, a display cabinet for the living room or a sideboard for the kitchen. The new façade lacquered in a warm Spice colour with Eucalyptus interiors re-proposes a classic piece in a contemporary version without betraying its origins as a rigorous but functional piece of furniture. The dimensions reflect current production.

Aldo Rossi e Luca Meda disegnano una vera e propria architettura, una grande facciata scandita dal ritmo regolare delle finestre e ispirata alla facciata della sede della Regione Umbria a Perugia. Una libreria vetrata con struttura in Eucalipto o laccata e facciata metallica laccata in colori opachi. Piroascafo è un versatile e raffinato magazzino domestico: libreria nello studio, vetrina in soggiorno, madia in cucina. La nuova facciata laccata in un caldo colore Spice con interni in Eucalipto ripropone un classico in una versione contemporanea senza tradire le sue origini di arredo rigoroso ma funzionale. Le dimensioni rispecchiano la produzione corrente.



PIROSCAFO —

BOOKCASE—
CHALK WHITE FRONT,
EUCALYPTUS STRUCTURE
OVAL TABLE ARC—
GREY BASE,
EXTRALIGHT GLASS TOP
MONTECATINI D.235.1 CHAIRS—
POLISHED ALUMINIUM

LIBRERIA—
FACCIATA BIANCO CALCE,
STRUTTURA EUCALIPTO
TAVOLO OVALE ARC—
BASAMENTO GRIGIO,
PIANO VETRO EXTRACHIARO
SEDIE MONTECATINI D.235.1—
ALLUMINIO LUCIDATO



CARTEGGIO

ALDO ROSSI

A wood writing desk with drawers and pull out top
protected by a blind. To organize and rearrange
our daytime.

Mobile secretaire a cassetti in essenza, con ripiano
estraibile protetto da una tapparella scorrevole. Per
organizzare e riordinare le nostre giornate.



D.950.1

GIO PONTI

Framed mirrors designed in 1950 in three several sizes. Cornici con specchio disegnate nel 1950 in tre diverse dimensioni. Sono realizzate in massello verniciato a mano in colore bianco.

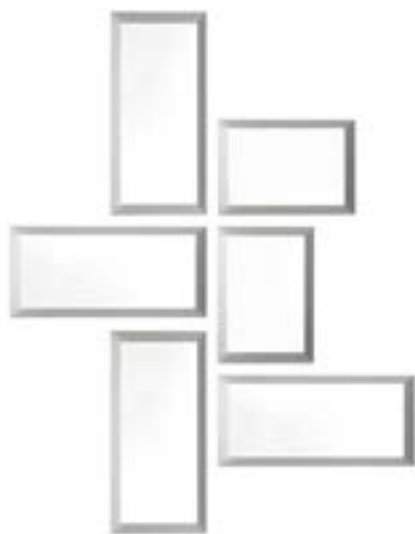

HERITA-
GE COL-
LECTION



HECTOR MIRROR

VINCENT VAN DUYSSEN

From the stylistic line of the Hector night system comes Hector Mirror, a mirror dictated by extreme minimalism. Hector Mirror can be hung on the wall or placed on the floor, available in bronze and pewter finishes with an aluminium frame. With its contemporary character, it fits into any environment, from the living to the sleeping area.

- Wall/floor-mounted mirror: W 750 X H 1900 mm
- Wall-mounted mirror: L 1200 X H 500 mm

Dalla linea stilistica del sistema notte Hector nasce Hector Mirror, uno specchio dettato dal minimalismo estremo. Hector Mirror può essere appeso a parete o appoggiato a terra, declinato nelle finiture bronzo e peltro con telaio in alluminio. Con il suo carattere contemporaneo, si posiziona in ogni ambiente, dal living alla zona notte.

- Specchio a parete / terra: L 750 X H 1900 mm
- Specchio a parete: L 1200 X H 500 mm.

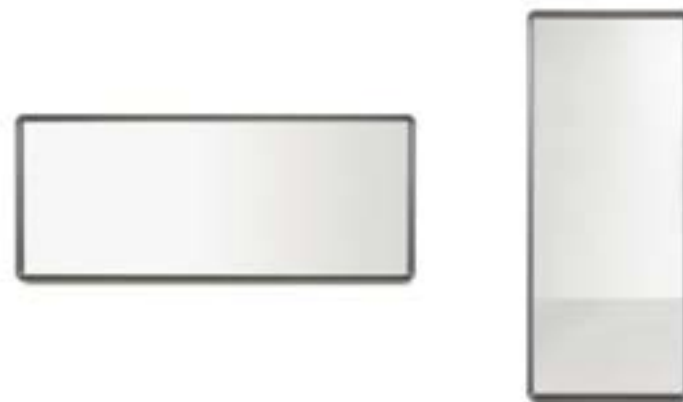

ATALANTE

AURA

CORBA

D.754.1

DEDALO

DUNA

EDGE

HEM

LOOP&CUT

MOSAICO

PALETTE

RANDOM

STRIPE

TELARO

VIBRAZIONI

carpet
collection



294 | 295



D.754.1

GIO PONTI

Rug of an unusual geometric form, designed in 1954, as a prototype, for the Ponti's house on via Dezza in Milan. Made of "Pony" leather in four colours: white, brown, black, beige.

Tappeto dall'insolita forma geometrica, disegnato nel 1954 come prototipo per la casa Ponti di via Dezza a Milano. Realizzato in pelle di cavallino a quattro colori: bianco, marrone, nero, beige.



WHITE



BLACK



BROWN



BEIGE

Dimensions / Dimensioni
240 x 245 cm

Pony leather

Pelle di cavallino



ATALANTE by Ruckstuhl

NICOLA GALLIZIA

Natural hemp fibres, hand woven according to ancient carpet weaving techniques, feature geometric surfaces of simple and elegant modernity. Distinct backgrounds, modulated like a musical score, become delightful decorative motifs in the material and in the natural colour combinations.

La fibra naturale di canapa, tessuta a mano secondo antiche tecniche del tappeto intrecciato, disegnano superfici geometriche di semplice ed elegante modernità. Campiture nette, ritmate come una partitura musicale, diventano motivo decorativo che trova la sua preziosità nella materia e nella naturalezza degli abbinamenti cromatici.



DESERT



VULCANO



LAVA

Dimensions / Dimensioni

300 x 200 cm

300 x 300 cm

400 x 300 cm

500 x 400 cm

Hand-tufted

Height fleece 12 mm

100% Hemp

Taftato a mano

Spessore 12 mm

100% Canapa



AURA

NICOLA GALLIZIA

Aura, designed in Italy by Nicola Gallizia for Molteni&C, is a rug produced in the Kathmandu valley in Nepal. The glossy and matt effects achieved by using vegetable silk and wool, which respond differently to the light, produce a refined and subtle monochromatic finish. The border, skillfully finished with scissors, completes the rug and adds a touch of elegance. The entire rug production process is performed by hand, from carding the raw materials to weaving right through to finishing.

Aura firmato da Nicola Gallizia per Molteni&C è un tappeto disegnato in Italia e prodotto nella valle di Kathmandu, Nepal. Gli effetti lucido ed opaco, dati dal contrasto seta vegetale e lana, restituiscono un comportamento diverso alla luce, che rende percepibile la raffinatezza del contrasto monocromatico. La bordura maestralmente realizzata a forbice in fase di finissaggio, completa il tappeto e aggiunge un tocco di eleganza. L'intero processo di produzione del tappeto viene realizzato a mano.



ANTHRACITE



BORDEAUX



JADE



PETROLEUM BLUE



SAGE

	Hand Loom	Telaio a mano
	Height fleece 6 mm	Spessore vello 6 mm
	Height border 3 mm	Spessore bordura 3 mm
Dimensions / Dimensioni	Ngari wool pile	Vello in lana Ngari
300 x 100 cm	rug with a Tibetan wool	e un twill di lana
300 x 250 cm	and viscose	tibetana e viscosa
400 x 300 cm	(or bamboo silk) twill	(o seta vegetale)
Ø 300 cm		



CORBA

MARTA FERRI

The Corba rug stands out for its extremely original pattern, dictated by a figurative design that animates the project by playing harmoniously with lines featuring a strong geometric expressiveness. With its elegant and sophisticated graphics, the Corba represents creativity and harmony without limits through the material used: the rug is 100% tencel, a vegetable yarn produced from wood pulp that is carefully harvested from responsibly managed forests.

Il tappeto Corba si contraddistingue per un pattern estremamente originale, dettato da un disegno figurativo che anima il progetto facendo leva su un gioco armonioso di linee dalla forte espressività geometrica. Con la sua grafica elegante e sofisticata, Corba traduce creatività ed armonia senza limiti attraverso il materiale utilizzato: il tappeto è 100% tencel, un filato vegetale prodotto dalla polpa di legno che viene accuratamente raccolto da foreste gestite consapevolmente.

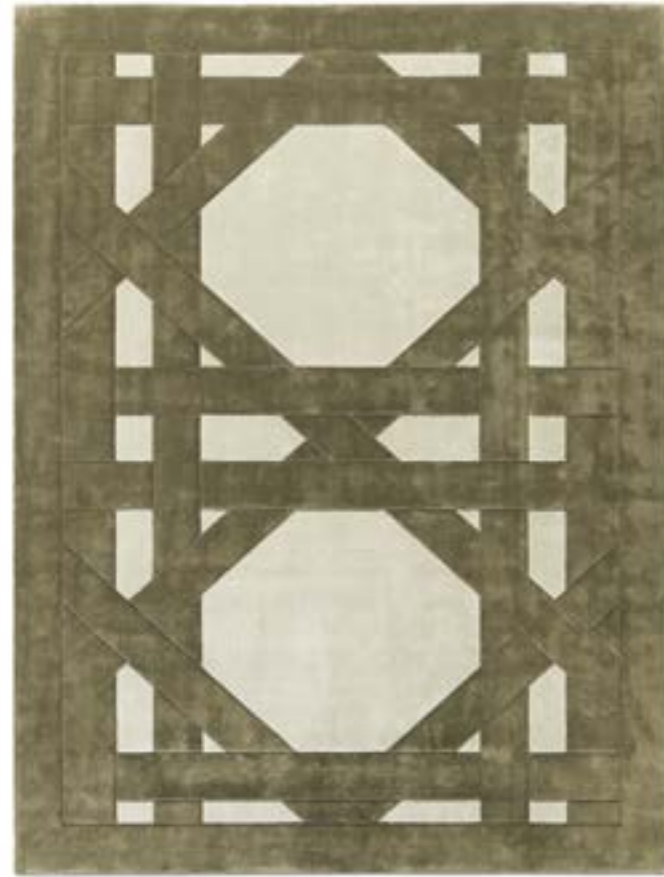

MINERAL



LIGHT STONE



Dimensions / Dimensioni

400 x 200 cm

300 x 300 cm

400 x 300 cm

500 x 300 cm

Hand-tufted

Height fleece 14 mm

100% Tencel

Taftato a mano

Spessore 14 mm

100% Tencel

DEDALO by Pierre Frey

MARTA FERRI

The Dedalo rug is characterised by a rigorous geometry and refined colours that are always the protagonists of the design, harmoniously integrating in the new everyday concept of the home. The project marks the first collaboration with the prestigious Maison Pierre Frey which, with over eighty years of experience, is a leader in the production of wonderful fabrics for curtains and upholstery. The exceptional know-how of Maison Pierre Frey thus combines with Molteni&C's obsession for quality and detail to create a project with an innovative design and strong visual impact.

Dedalo si caratterizza per una geometria rigorosa e da cromie ricercate e sempre protagoniste nel progetto, in grado di integrarsi con armonia al nuovo concetto quotidiano di casa. Il progetto segna una prima collaborazione con la prestigiosa Maison Pierre Frey che, con oltre ottanta anni di storia, è leader nella produzione di meravigliosi tessuti per tendaggi e imbottiti. L'eccezionale know-how della Maison Pierre Frey si unisce così all'ossessione per la qualità e per i dettagli di Molteni&C nella creazione di un progetto innovativo nel design e dal forte impatto visivo.



ORANGE SPARK

SOFT GREY

Dimensions / Dimensioni

400 x 200 cm
300 x 300 cm
400 x 300 cm
500 x 300 cm

Hand-tufted with carving Taftato a mano con carving
Height fleece 15 mm Spessore 15 mm
70% Tencel, 30% Wool 70% Tencel, 30% Lana



DUNA

NICOLA GALLIZIA

Inspired by the geometric impermanence of the desert dunes, Duna is made of wool and bamboo platted in various thicknesses to produce the effect of furrows of sand. Its modularity gives rise to an elegant and simple decorative effect. Handcrafted using the manual tufting method, Duna is available in three versions of warm and natural colors: Ivory, Tobacco and Anthracite.

Ispirato all'impermanenza geometrica delle dune del deserto, Duna è realizzato in lana e bambù intrecciati in vari spessori per produrre l'effetto dei solchi di sabbia. La ripartizione in moduli dà vita ad un effetto decorativo all'insegna dell'eleganza e della semplicità. Realizzato artigianalmente con metodo tufting manuale, Duna è disponibile in tre versioni di colori naturali ed accoglienti: Ivory, Tobacco e Anthracite.



ANTHRACITE



TOBACCO



IVORY

Dimensions / Dimensioni
 400 x 200 cm
 300 x 300 cm
 400 x 300 cm
 500 x 300 cm

Hand-tufted
 Height fleece 12 mm
 Density 5 kg/mq
 75% New Zealand Wool
 25% Bamboo

Taftato a mano
 Spessore 12 mm
 Peso 5 kg/mq
 75% New Zealand Wool
 25% Bamboo



EDGE

NICOLA GALLIZIA

Wool and linen, materials from the most sophisticated tradition of carpet manufacturing, mixed in a new way for a new soft and bright feel. The conventional edge of the carpet, which frames the central field, reinvents the decoration using the colours of our memory. It is a return to simple and elegant chromatic lines.

Lana e lino, materia della più sofisticata tradizione del tappeto, mescolate in maniera nuova diventano una inedita superficie morbida e luminosa. Il tradizionale bordo del tappeto che riquadra la campitura centrale, reinventa la decorazione utilizzando colori della memoria riportandola a segno grafico e cromatico semplice ed elegante.



BLUE GRADIENT BORDER



BROWN GRADIENT BORDER



GREEN GRADIENT BORDER



MOON GRADIENT BORDER



ROSE GRADIENT BORDER

Dimensions / Dimensioni	Hand-tufted	Taftato a mano
300 x 300 cm	Height fleece 18 mm	Spessore 18 mm
400 x 300 cm	Gradient border 40 cm	Gradiente bordo 40 cm
500 x 300 cm	80% Mohair wool	80% Lana mohair
Ø 500 cm	20% Linen	20% Lino



HEM by G.T.Design

PATRICIA URQUIOLA

Rugs return to their original purpose as islands or places where people sit down together and forget their daily worries. Always different, they express a blend of the highest western creativity and ancient Asian craft traditions. From the long-standing partnership between Molteni&C and Patricia Urquiola, a new family of products: two floor rugs together in an exclusive collection. Hem and Loop & Cut are together in this exclusive collection. This combination uses natural materials to create a harmonious rug collection.

Il tappeto ritorna all'antica funzione di isola, dove ritrovarsi e dimenticare gli affanni quotidiani. Sempre diverso, perché frutto dell'incontro tra la più alta creatività occidentale e la millenaria artigianalità asiatica. La lunga collaborazione tra Molteni&C e Patricia Urquiola si arricchisce di una nuova famiglia di prodotti: due tappeti, Hem e Loop&Cut, riuniti in una collezione esclusiva. Ed è proprio questo incontro, unito a materiali naturali a dar vita a una collezione di tappeti di grande armonia.



STONE



SAND

Dimensions / Dimensioni	Hand knotted	Realizzati a mano
300 x 250 cm	Height fleece 6 mm	Spessore 6 mm
400 x 300 cm	100% Bamboo silk	100% Bamboo silk
Ø 250 cm	Density	Densità
	86.000 knots/mq	86.000 nodi/mq



LOOP&CUT by G.T.Design

PATRICIA URQUIOLA

Loop&Cut is inspired by techniques used in knitting, and especially by the ribbing on pullover cuffs, used for these rugs as edging. A feature that gives the product character and a touch of originality. A meeting between the highest Western creativity and millennial Asian craftsmanship. Ancient hands interpret the designs, contributing with small personal variations which have always been the weavers prerogative.

La personalità e l'originalità di questo manufatto derivano dall'elemento di rifinitura del bordo, che è mutuato dalle tecniche utilizzate in maglieria e, in particolare, alla lavorazione a costine dei polsini dei pullover. Un incontro tra la più alta creatività occidentale e la millenaria artigianalità asiatica: mani antiche interpretano i disegni, realizzando piccole variazioni personali, frutto di un'abilità da sempre insita nel lavoro della tessitrice.



STONE



ARTIC

Dimensions / Dimensioni
300 x 250 cm
400 x 300 cm

Hand woven
Height fleece 6 mm
60% Viscose
40% Linen

Tessuto a mano
Spessore 6 mm
60% Viscosa
40% Lino



MOSAICO Frammenti Collection

MARTA FERRI

The geometric lines of the Mosaico rug define the spaces, enclosing them in coloured sections marked by sophisticated contrasting shades. The colours seem to move, with cold greys alternating with the warm and harmonious colours of nature. Fibres such as wool and tencel give the whole structure a solid, material look.

Nel tappeto Mosaico le linee geometriche definiscono gli spazi, racchiudendoli in sezioni colorate delineate da sofisticate cromie a contrasto tra loro. Sono colori in movimento, il freddo dei grigi si alterna ai colori caldi e armoniosi della natura. Fibre come la lana e il tencel, favoriscono un aspetto solido e materico all'intera struttura.



DESERT



STEPPE



Dimensions / Dimensioni

400 x 200 cm	Hand-tufted	Taftato a mano
300 x 300 cm	Height fleece 14 mm	Spessore 14 mm
400 x 300 cm	50% Mohair - 25% Tencel	50% Mohair - 25% Tencel
500 x 400 cm	25% New Zealand Wool	25% New Zealand Wool



PALETTE

NICOLA GALLIZIA

A collection consisting of matter and colour, the decorative peculiarity of these carpets is their essential elegance. The vibrato depth of colour creates a soft and enveloping effect that functions as ordering element of space.

È una collezione costruita di materia e colore, cifra decorativa di questi tappeti eleganti proprio perché essenziali. Il vibrato del colore crea un effetto morbido e avvolgente che accoglie e diventa elemento ordinatore dello spazio.

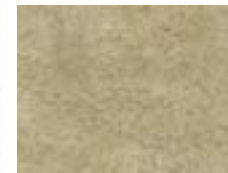

CREAM



DOVE GREY



ANTHRACITE



TAUPE



BORDEAUX



PETROLEUM BLUE

Dimensions / Dimensioni

300 x 300 cm

Hand-tufted

Taftato a mano

400 x 300 cm

Height fleece 18 mm

Spessore 18 mm

500 x 300 cm

100% Tencel

100% Tencel



RANDOM by Altai

PATRICIA URQUIOLA

The charm of an ancient rug, with its marked individuality and well-worn look, is the source of inspiration for Random. The well-worn look is the key feature, expressing itself in an original exaltation of the texture of the rug, created with an innovative hand-woven technique, which highlights the structure of the weave.

Il fascino del tappeto antico con la sua spiccata individualità e il suo aspetto vissuto è la fonte di ispirazione che ha portato alla creazione di Random. Il vissuto a cui si ispira, diventa l'elemento caratterizzante esprimendosi in una originale esaltazione della trama del tappeto creata attraverso una innovativa tecnica di lavorazione a mano che mette in rilievo la struttura del tessuto.



ARTIC



PLATINUM



POWDER PINK

	Hand knotted	Annodato a mano
	Height fleece 12/14 mm	Spessore 12/14 mm
	Density	Densità
Dimensions / Dimensioni	40.000 knots/mq	40.000 nodi/mq
300 x 200 cm	80 % Bamboo silk,	80% Bamboo silk,
400 x 300 cm	10 % Cotton, 10% Wool	10% Cotone, 10% Lana
Ø 300 cm	Backing: natural latex	Appoggio: lattice naturale



STRIPE

VINCENT VAN DUYSSEN

The sophisticated beauty of these soft surfaces is the result of a deliberate contrast between the simplicity of the design and decorative detail and the richness of the material. Slender alternating stripes of wool and silk create geometric backgrounds in shades of tone-on-tone colours that delicately reflect the light. Harmonious balance between rigour and form.

La sofisticata bellezza di queste morbide superfici nasce dal voluto contrasto tra essenzialità del disegno e del dettaglio decorativo e la ricchezza della materia. Sottili righe alternate di lana e seta creano campiture geometriche in nuances di colori tono su tono che riflettono delicatamente la luce. Armonioso equilibrio tra rigore e forma.



CREAM GREY

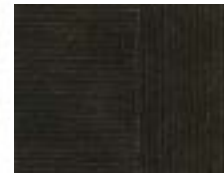

MILITARY GREEN

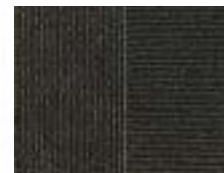

MINT GREEN

Dimensions / Dimensioni

500 x 400 cm
400 x 300 cm
300 x 300 cm
400 x 200 cm

Hand-tufted

Height fleece 14 mm

50% Wool, 50% Tencel

Taftato a mano

Spessore 14 mm

50% Lana, 50% Tencel



TELARO by Amini

MARTA FERRI

Telaro is a rug featuring a geometric motif and a linear pattern. A series of spaces arranged regularly with each other, featuring different sizes and orientations which thus define a contrasting grid. The precious semi-combed wool rug features a woven surface distinguished by a play of reliefs, achieved by means of skilled craftsmanship through hand loom.

Dal motivo geometrico e lineare nasce il tappeto Telaro. Un susseguirsi di spazi disposti regolarmente tra loro, caratterizzati da diverse grandezze e orientamenti che definiscono così una griglia a contrasto. Il tappeto, in preziosa lana semi pettinata, presenta una superficie intrecciata e contraddistinta da un gioco di rilievi, ottenuti da un'abile tecnica artigianale: la realizzazione tramite telaio manuale.



ANTHRACITE



COGNAC



NATURAL

Dimensions / Dimensioni

400 x 200 cm	Hand loomed	Intelaiato a mano
300 x 300 cm	Height fleece 6/7 mm	Spessore 6/7 mm
400 x 300 cm	Density 3,4 kg/mq	Peso 3,4 kg/mq
500 x 300 cm	Semi worsted wool	Lana semi pettinata

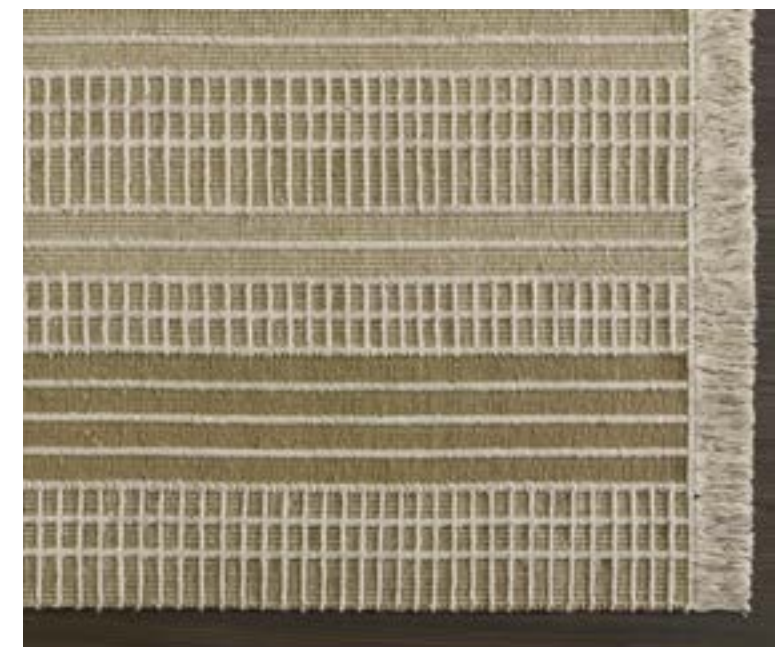

VIBRAZIONI Frammenti Collection

MARTA FERRI

Constantly changing scenarios give rise to Vibrazioni. Scenari in trasformazione in continuo cambiamento, dai quali nasce Vibrazioni. Un gioco optical visivo e tattile, grazie agli spessori e tra mature su diversi livelli che ne caratterizzano l'intera superficie del tappeto. Giochi di luci e ombre favoriti da una fibra lucente qual'è il rayon, poche tinte sapientemente ricercate che variano a seconda della luce.

A visual and tactile interplay, thanks to differing thicknesses and weaves on different levels that characterize the whole surface of the rug. Interplays of light and shade favoured by a glossy fibre such as rayon, skillfully combined dyes that vary according to the light.



ICE



GRANITE



CLAY



GEM



EARTH



OBSIDIAN

Dimensions / Dimensioni

300 x 300 cm

400 x 200 cm

400 x 300 cm

500 x 400 cm

Hand-tufted

Height fleece 16/22 mm

100% Bamboo

Taftato a mano

Spessore 16/22 mm

100% Bamboo



FINISHES

	Matt lacquer 3d matt lacquer Laccato opaco 3D laccato opaco	Glossy lacquer Laccato lucido	Coloured glass Vetro colorato	Etched coloured glass Vetro acidato colorato
CHALK WHITE / BIANCO CALCE BC	•	•	•	•
ALMOND WHITE AW	•	•	•	•
PEARL / PERLA PE	•	•	•	•
SILICA / SILICE SI	•	•	•	•
SAND / SABBIA SA	•	•	•	•
DOVE GREY / TORTORA TO	•	•	•	•
PLATINUM / PLATINO PL	•	•	•	•
LONDON SKY LS	•	•	•	•
DUNE / DUNA DN	•	•	•	•
CLAY / ARGILLA AL	•	•	•	•
DOLOMITE GREY / DOLOMITE DO	•	•	•	•
COPPER / RAME RX	•	•	•	•
RUBY / RUBINO RU	•	•	•	•
BURGUNDY / BORGOGNA BG	•	•	•	•
MOKA MK	•	•	•	•

	Matt lacquer 3d matt lacquer Laccato opaco 3D laccato opaco	Glossy lacquer Laccato lucido	Coloured glass Vetro colorato	Etched coloured glass Vetro acidato colorato
MUSTARD / SENAPE SE	•	•	•	•
SPICE SP	•	•	•	•
STARDUST SU	•	•	•	•
MOONLIGHT ML	•	•	•	•
LIGHT BLUE GREY / CARTA DA ZUCCHERO CZ	•	•	•	•
PETROLEUM BLUE / PETROLIO PR	•	•	•	•
PEWTER COLOUR / PELTRO PX	•	•	•	•
ANTHRACITE / ANTRACITE AT	•	•	•	•
PINE GREEN PG	•	•	•	•
BLACK / NERO NE	•	•	•	•
LESSLESS SILVER GREY / GRIGIO ARGENTO GA	•	•	•	•
LESSLESS RED / ROSSO RL	•	•	•	•

SPECIAL FINISHES FINITURE SPECIALI

GLAZE GBX	only 505 UP, Gliss Master solo 505 UP, Gliss Master
SLATE / LAVAGNA LA	only Hector solo Hector

ECLIPSE LEC	only Blevio solo Blevio
GALAXY GY	only Cleo solo Cleo

SPECIAL GLASSES VETRI SPECIALI

STOPSOL VTST, STOPSOL TRANSPARENT VTSR,
SILVER STOPSOL VTSS, BRONZE STOPSOL VTSB,
3D ETCHED BRONZE (LINEAR) V3BZ, NET GLASS VTSN,
SMOKED GLASS VTFU, BRONZE MIRROR SPB
GRAFENE only Half a Square, Diamond VTRR

STOPSOL **VTST**, STOPSOL TRASPARENTE **VTSR**,
STOPSOL SILVER **VTSS**, STOPSOL BRONZO **VTSB**,
3D ACIDATO BRONZO (LINEAR) **V3BZ**, VETRO NET **VTSN**,
VETRO FUMÉ **VTFU**, SPECCHIO BRONZO **SPB**
GRAFENE solo Half a Square, Diamond **VTRR**

The colour code preceded by "H" indicates the 3D finish (es. **BC** → **HBC**).
Il Codice Colore preceduto dal prefisso "H" indica la finitura 3D (es. **BC** → **HBC**).



**WOODS
ESSENZE**

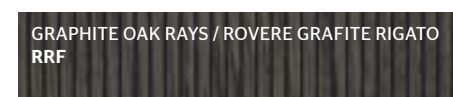
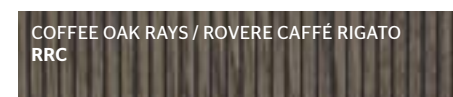
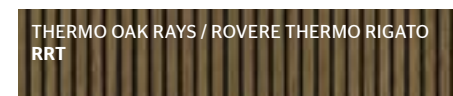
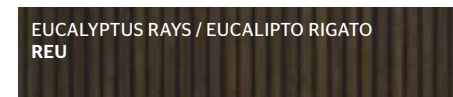
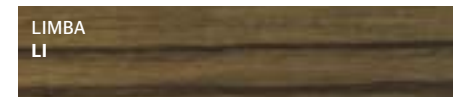
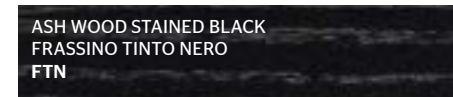
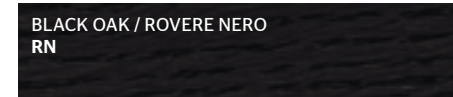
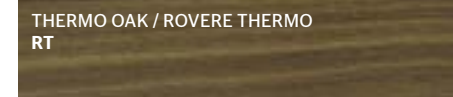
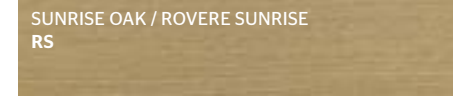
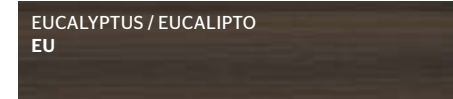

**MARBLES
MARMI**

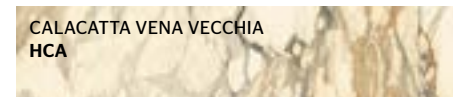
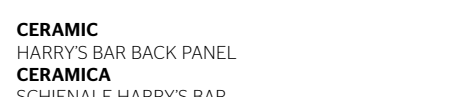
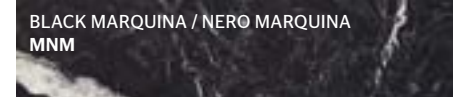
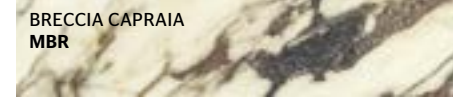
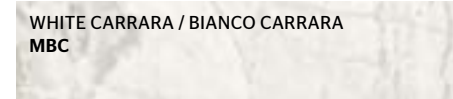

**METAL PARTS
PARTI METALLICHE**

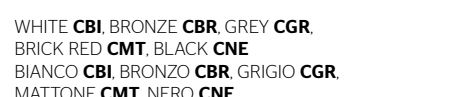
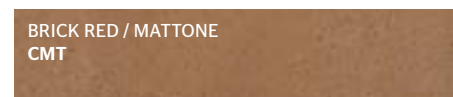
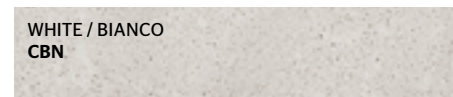
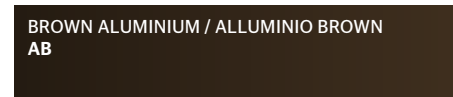
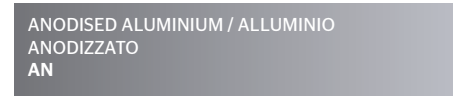
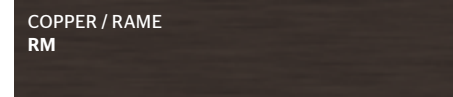
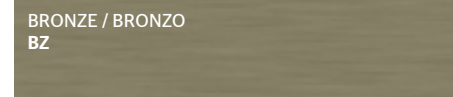
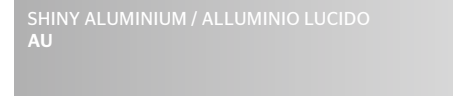
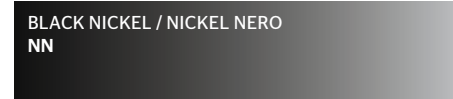

**CEMENT
CEMENTO**
ARC
WHITE **CBI**, BRONZE **CBR**, GREY **CGR**,
BRICK RED **CMT**, BLACK **CNE**
BIANCO **CBI**, BRONZO **CBR**, GRIGIO **CGR**,
MATTONE **CMT**, NERO **CNE**

**BATIK MELAMINE
NOBILITATO BATIK
PASS-WORD EVOLUTION**

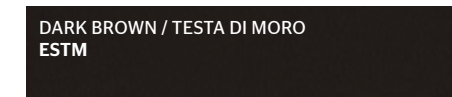
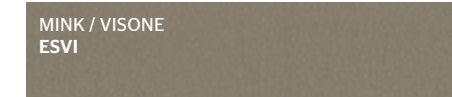
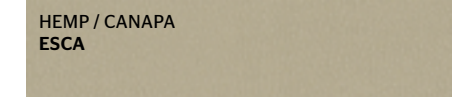
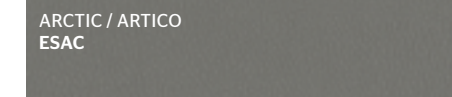
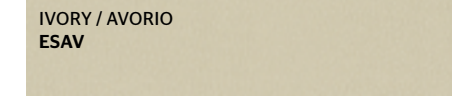

**MELAMINE FRONT
NOBILITATO FACCIATA
GLISS MASTER**

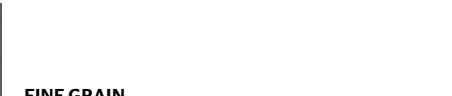
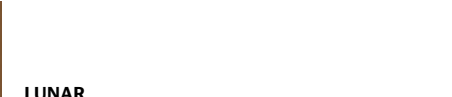
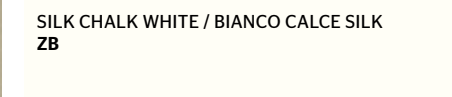
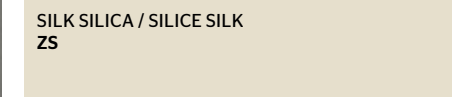
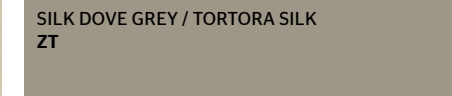
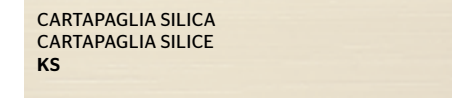
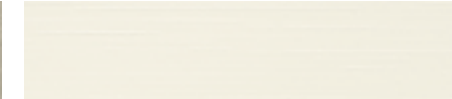

**PIQUÉ MELAMINE
NOBILITATO PIQUÉ**

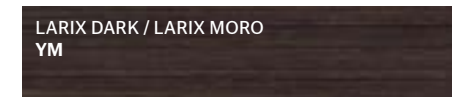
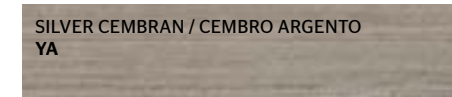
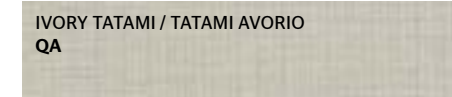
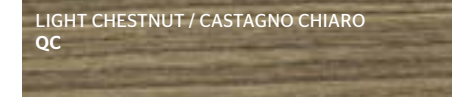
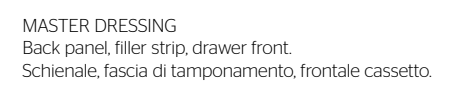
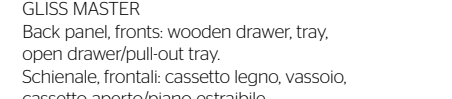

The finishes shown are indicative and refer to the entire production range. We recommend that you consult the "Colour Range" samples which shown the complete range of finishes, including those not shown here. Molteni&C reserves the right to modify the range without warning.
Le finiture fornite sono solo indicative e si riferiscono all'intera produzione. Si raccomanda di consultare il campionario "Gamma Colori" completo di tutte le finiture, anche quelle qui non riportate. Molteni&C si riserva di apportare modifiche senza obbligo di preavviso.





TECHNICAL DRAWINGS
DISEGNI TECNICI

ARC FOSTER + PARTNERS

ROUND TABLES
TAVOLI ROTONDI

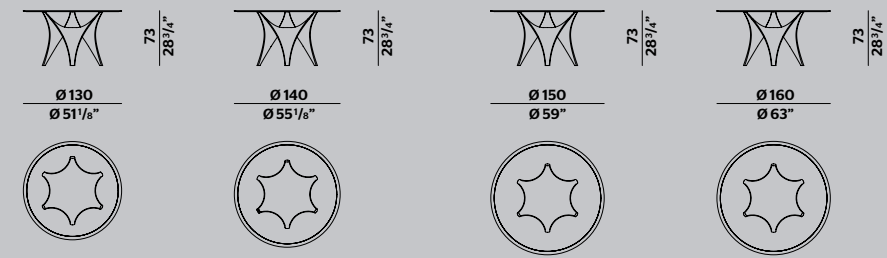

OVAL TABLES
TAVOLI OVALI

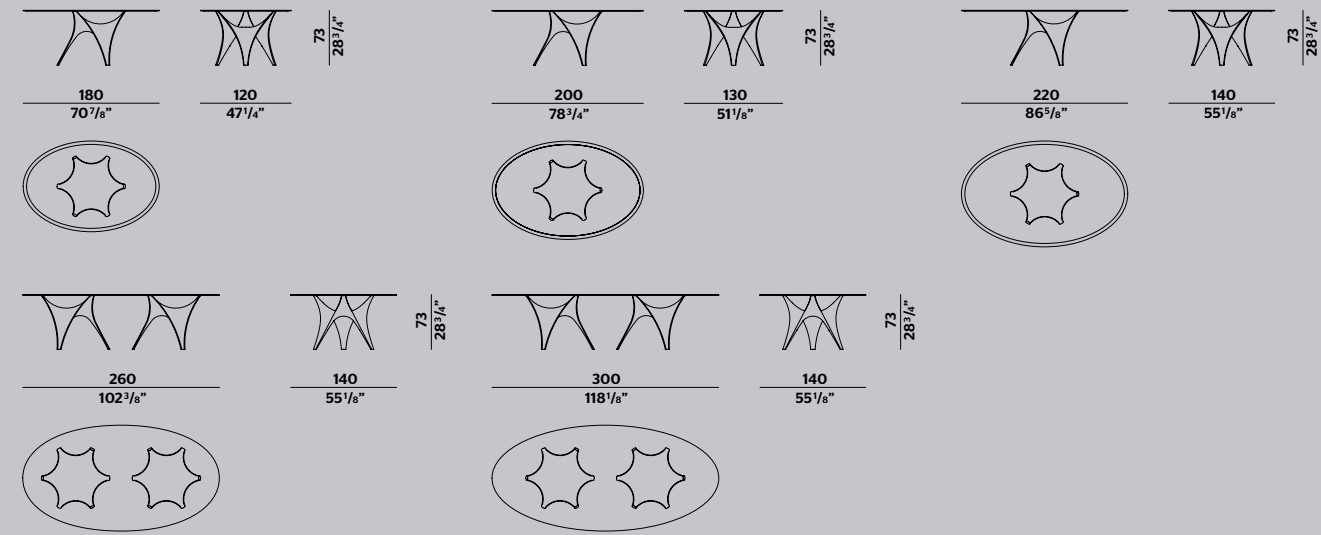

ASTERIAS PATRICIA URQUIOLA

ROUND TABLES
TAVOLI ROTONDI

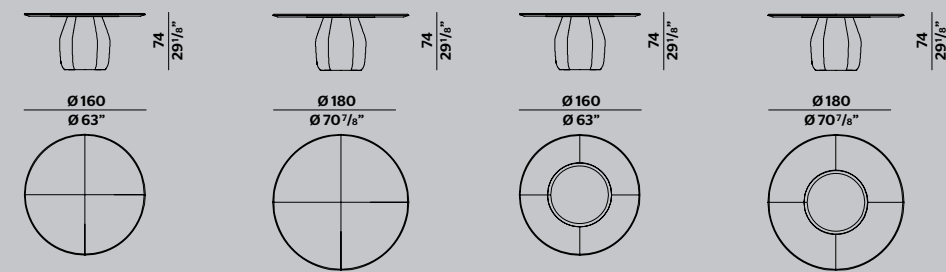

ROUND TABLES WITH LAZY SUSAN \varnothing 33 1/2"
TAVOLI ROTONDI CON PIATTO GIREVOLE \varnothing 85

AVA TABLE FOSTER + PARTNERS

RECTANGULAR TABLES
TAVOLI RETTANGOLARI

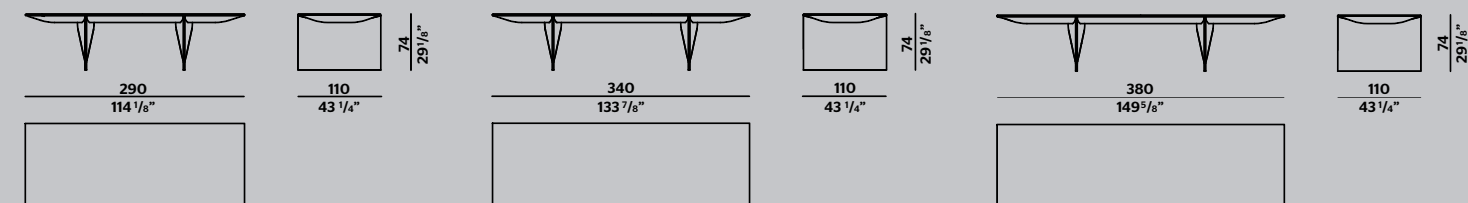

BLEVIO IGNAZIO GARDELLA

TABLE
TAVOLO

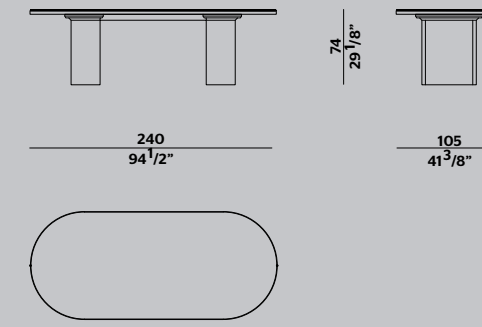

TABLE
TAVOLO

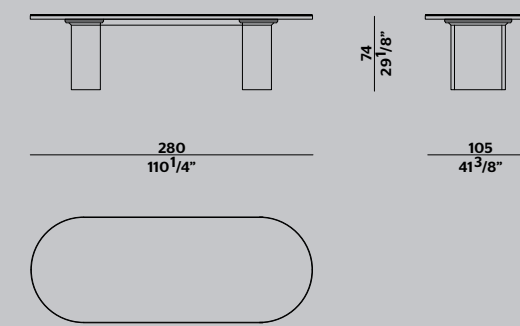
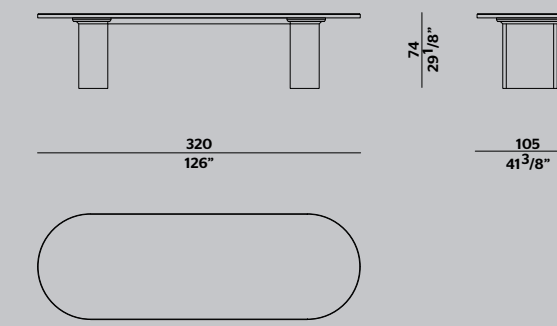

TABLE
TAVOLO



D.859.1 GIO PONTI

TABLE
TAVOLO

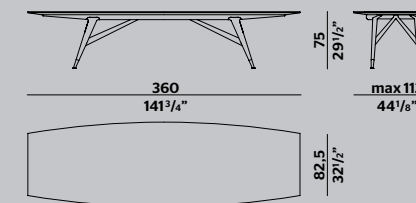

TABLE
TAVOLO

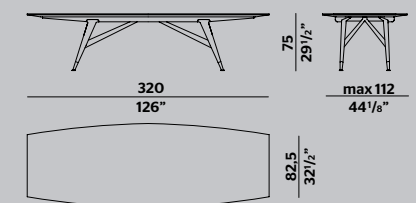
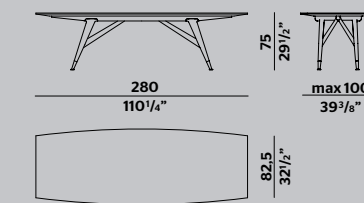
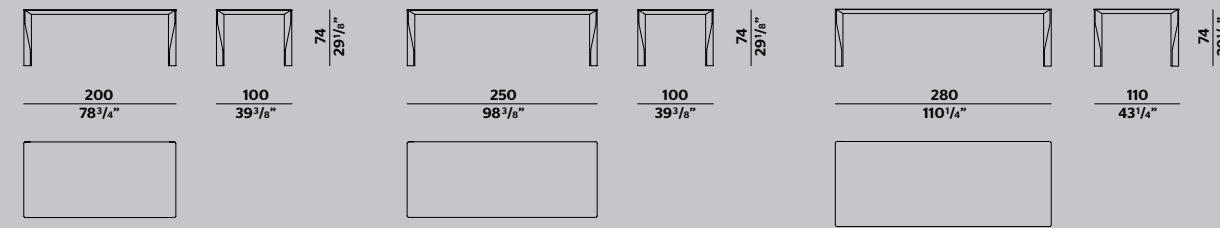

TABLE
TAVOLO



DIAMOND PATRICIA URQUIOLA

RECTANGULAR TABLES
TAVOLI RETTANGOLARI



SQUARE TABLES
TAVOLI QUADRATI

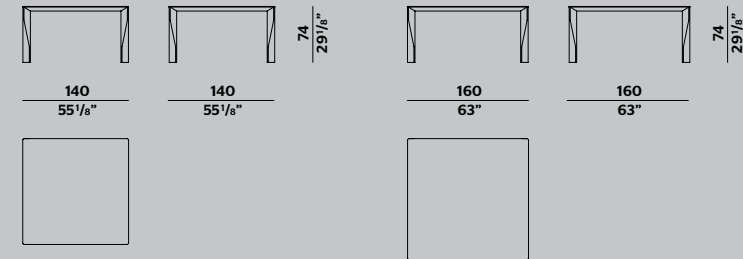

FILIGREE RODOLFO DORDONI

RECTANGULAR EXTENDABLE TABLE
TAVOLO RETTANGOLARE ALLUNGABILE

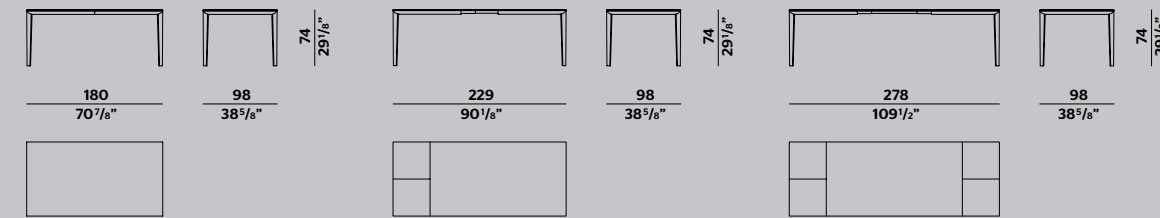

FIXED RECTANGULAR TABLES
TAVOLI RETTANGOLARI FISSI

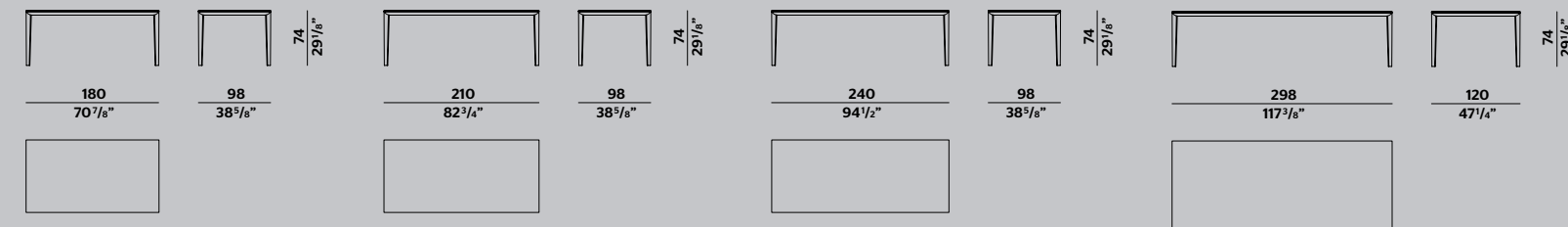

GATWICK RODOLFO DORDONI

OVAL TABLES
TAVOLI OVALI

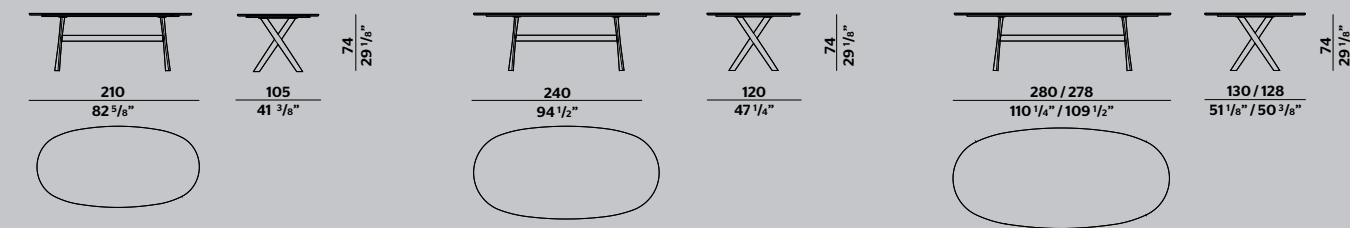

HALF A SQUARE MICHAEL ANASTASSIADES

SQUARE TABLE
TAVOLO QUADRATO

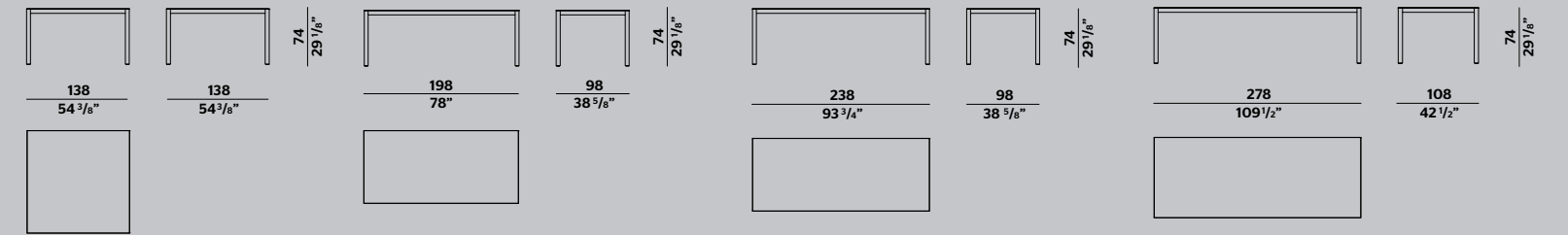

MATEO VINCENT VAN DUYSSEN

ROUND DINING TABLES
TAVOLI DINING ROTONDI

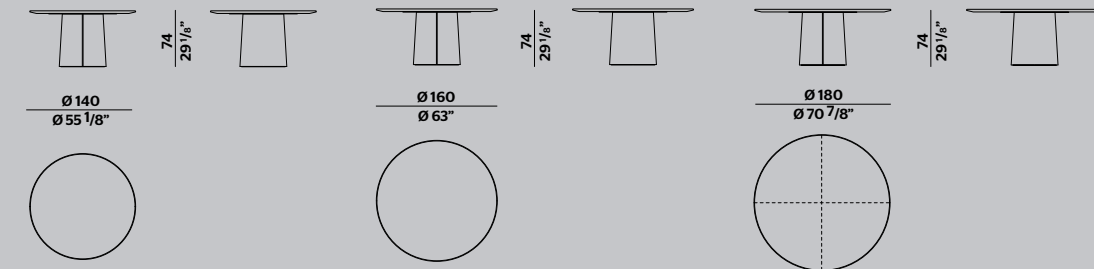

ROUND DINING TABLES
TAVOLI DINING ROTONDI

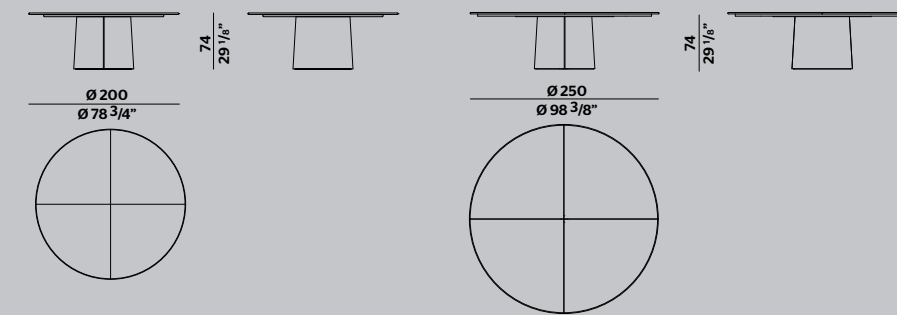

OVAL DINING TABLES
TAVOLI DINING OVALI

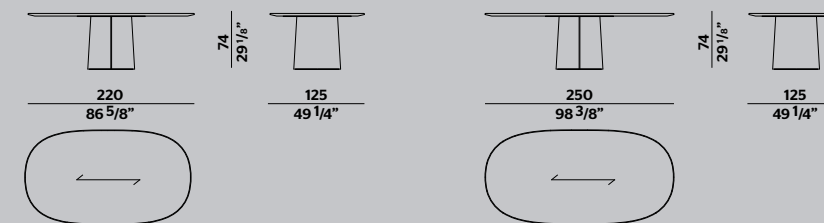

ROUND LOUNGE TABLES H 64
TAVOLI LOUNGE ROTONDI H 64

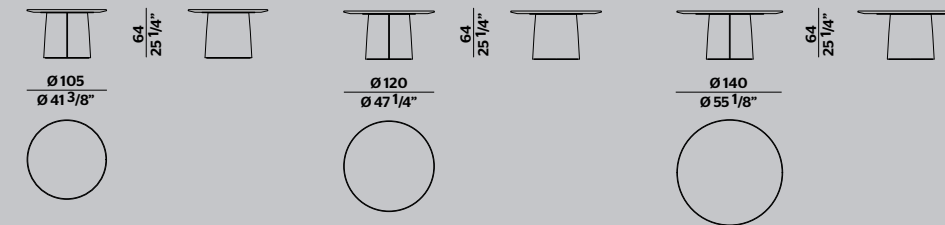

ROUND LOUNGE TABLE H 74
TAVOLO LOUNGE ROTONDO H 74

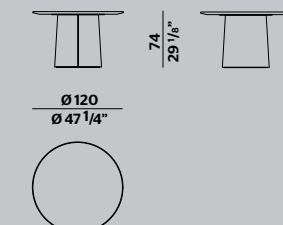

OLD FORD RODOLFO DORDONI

WOODEN TABLES
TAVOLI ESSENZA

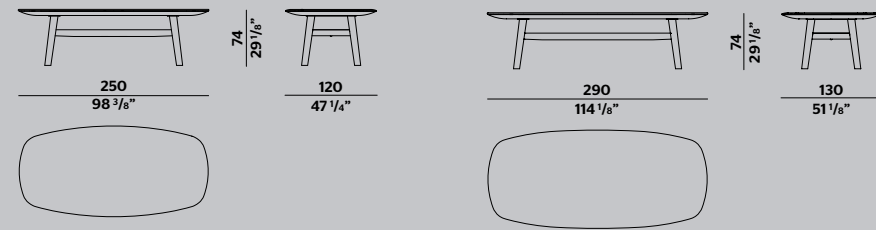

MARBLE TABLES
TAVOLI MARMO

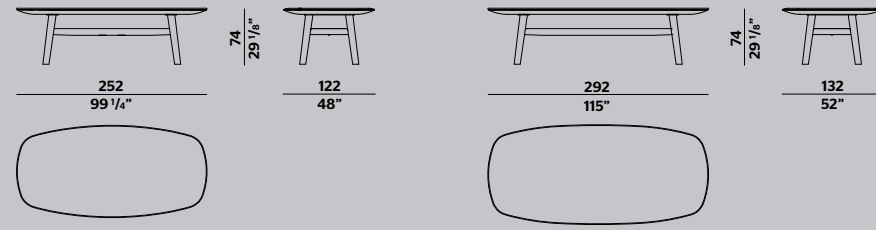

MARBLE TABLE
TAVOLO MARMO

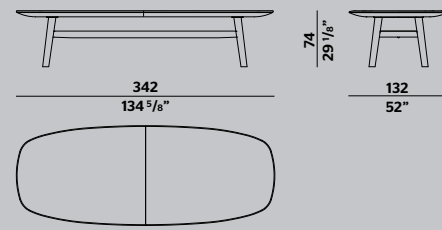

NOTE MATTEO NUNZIATI

WRITING DESK
SCRITTOIO

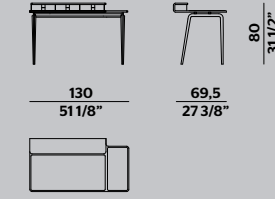

LESSLESS JEAN NOUVEL

TABLES
TAVOLI

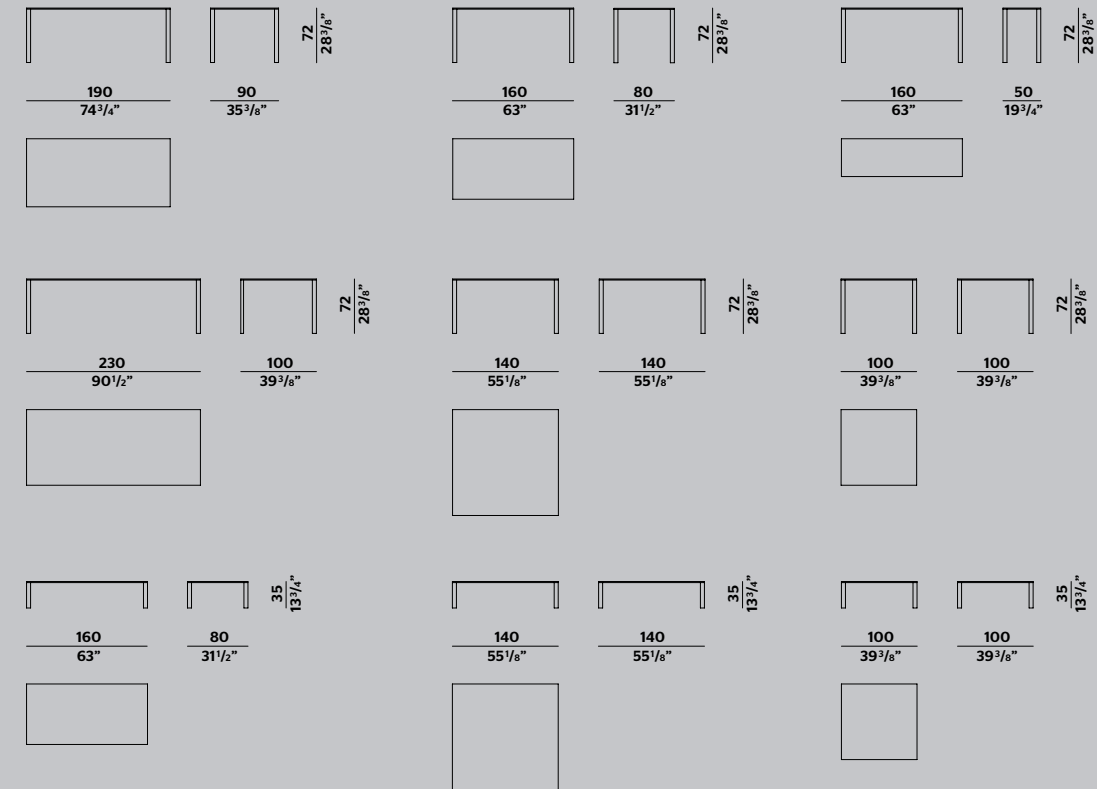

SCRIBA PATRICIA URQUIOLA

WRITING DESKS
SCRITTOI

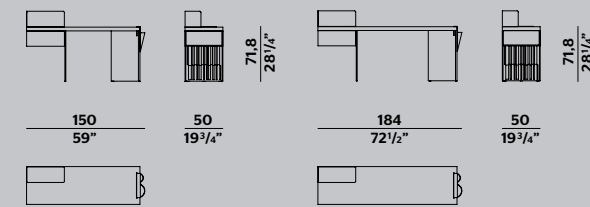

D.847.1 GIO PONTI

WRITING DESK
SCRITTOIO

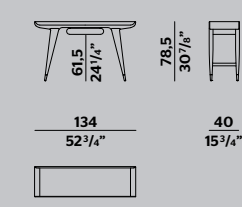

TOUCH DOWN UNIT STUDIO KLASS

MOBILE STATION
POSTAZIONE MOBILE

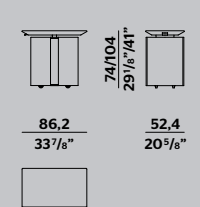

45°/VETRINA RON GILAD

SHOWCASE
VETRINA

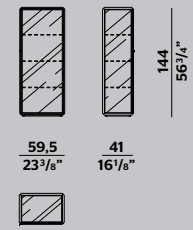

ADRIEN VINCENT VAN DUYSSEN

CUPBOARDS
MADIE

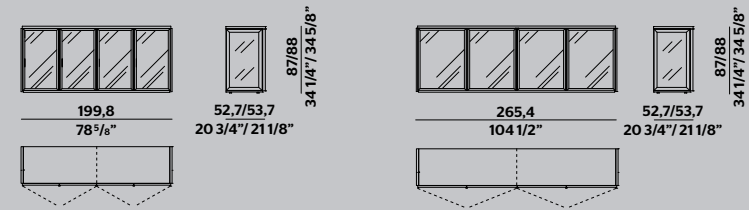

ARCHWAY RODOLFO DORDONI

CUPBOARDS
MADIE

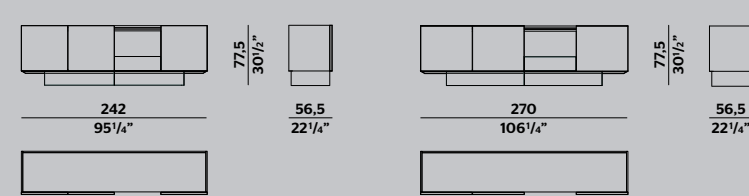

CARTEGGIO ALDO ROSSI

UNIT WITH DRAWERS
MOBILE A CASSETTI

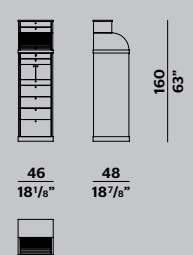

D.655.1 D.655.2 GIO PONTI

CHEST OF DRAWERS
CASSETTONI

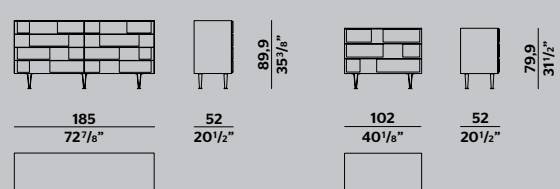

HORIZONS DANTE BONUCCELLI

CUPBOARDS
MADIE

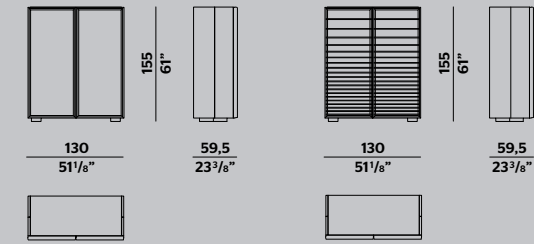

MHC.1 WERNER BLASER

CHEST OF DRAWERS
CASSETTIERA

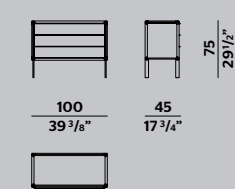

LIVING BOX VINCENT VAN DUYSSEN

BOX
BOX

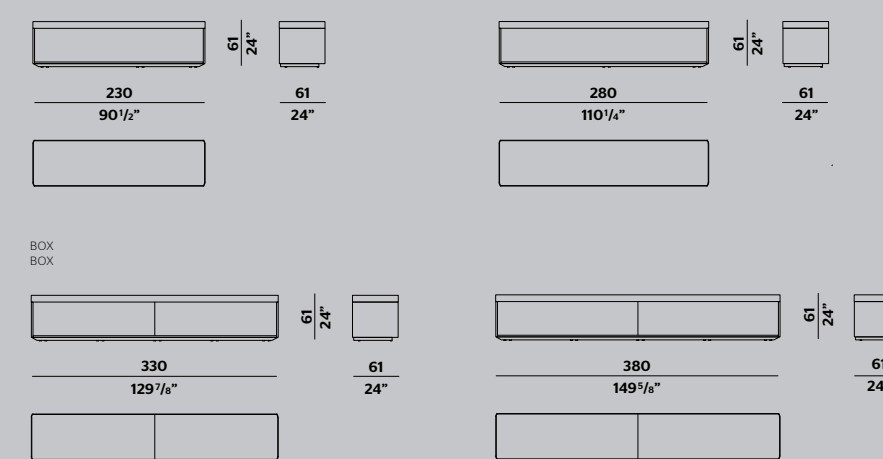

DRAWER MODULES
MODULI CASSETTO

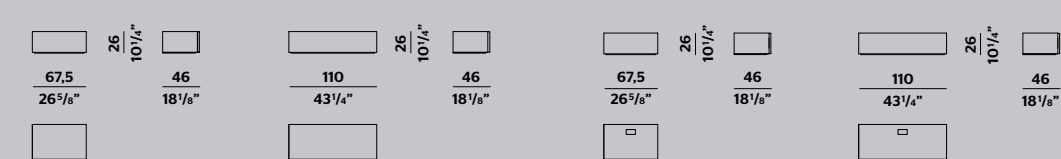

TAPE MODULES
MODULI TAPE

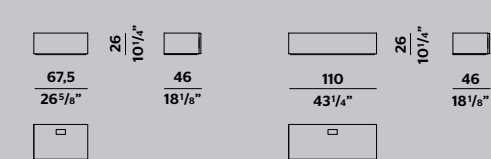

QUINTEN VINCENT VAN DUYSSEN

CUPBOARDS
MADIE

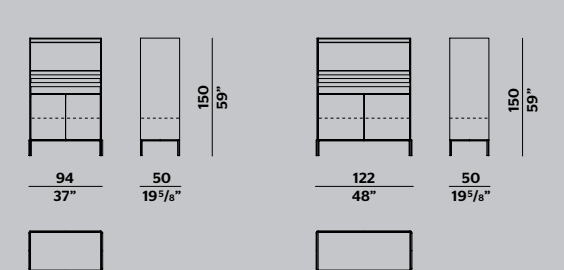

TEOREMA RON GILAD

UNITS WITH DRAWERS OR OPEN COMPARTMENT
CONTENITORI A CASSETTO O A GIORNO

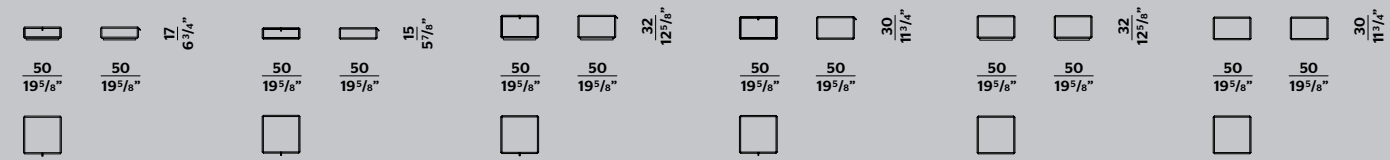

VERTICAL COMPOSITIONS H 18 1/2"
COMPOSIZIONI VERTICALI H 47

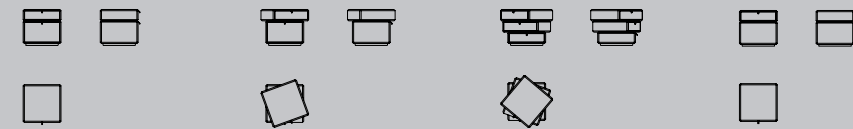

VERTICAL COMPOSITIONS H 24 3/8"
COMPOSIZIONI VERTICALI H 62



VERTICAL COMPOSITIONS H 30 3/8"
COMPOSIZIONI VERTICALI H 77

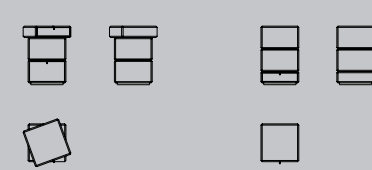

VERTICAL COMPOSITIONS H 36 1/4"
COMPOSIZIONI VERTICALI H 92

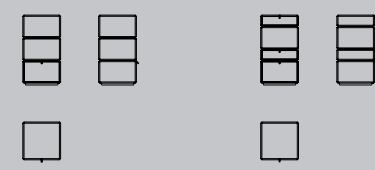

VERTICAL COMPOSITION H 42 1/8"
COMPOSIZIONE VERTICALE H 107

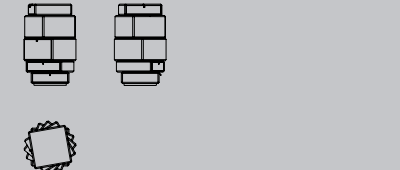

VERTICAL COMPOSITIONS H 48"
COMPOSIZIONI VERTICALI H 122

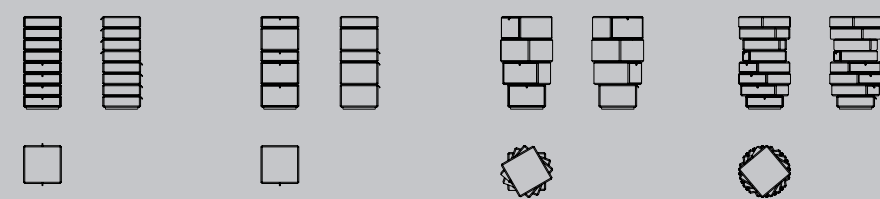

HORIZONTAL COMPOSITION H 12 5/8"
COMPOSIZIONE ORIZZONTALE H 32

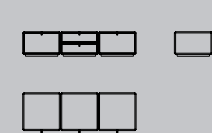

HORIZONTAL COMPOSITIONS H 24 3/8"
COMPOSIZIONI ORIZZONTALI H 62

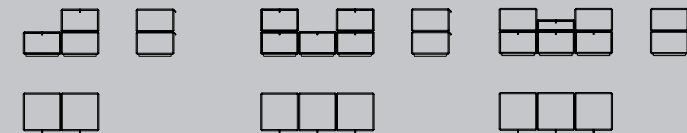

AVA FOSTER + PARTNERS

BOOKCASE
LIBRERIA

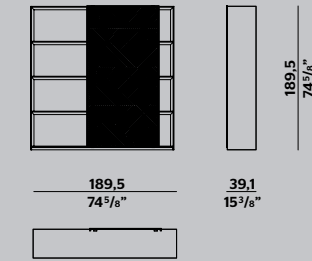

D.355.1 D.355.2 GIO PONTI

SUSPENDED BOOKCASES
LIBRERIE SOPESE

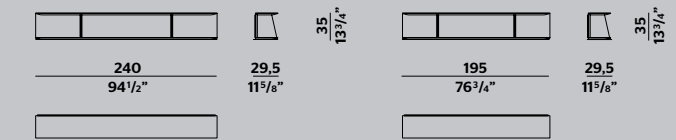

D.357.1 D.357.2 GIO PONTI

BOOKCASES
LIBRERIE

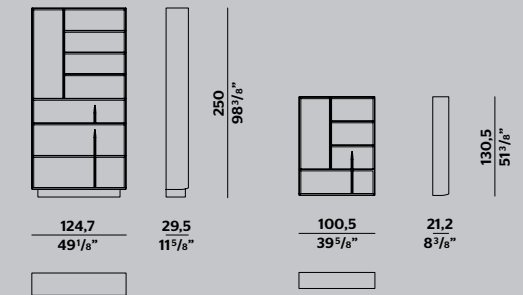

GRADUATE JEAN NOUVEL

BOOKCASES
LIBRERIA

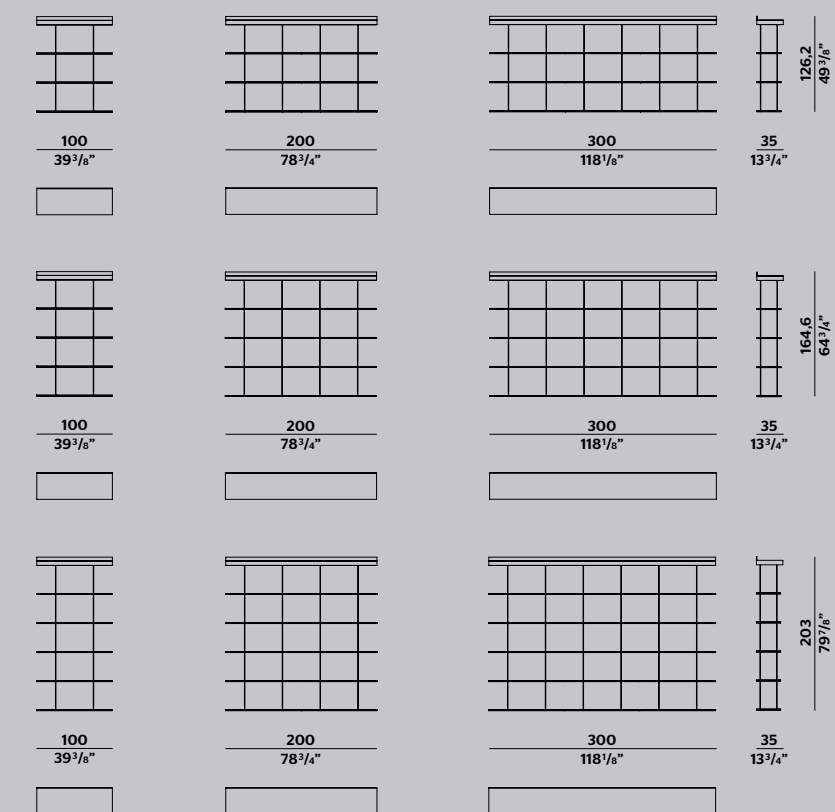

MHC.2 YASUHIKO ITOH

BOOKCASES
LIBRERIE

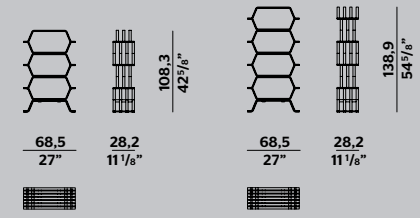

PIROSCAFO, 30TH ANNIVERSARY ALDO ROSSI, LUCA MEDA

BOOKCASES
LIBRERIE

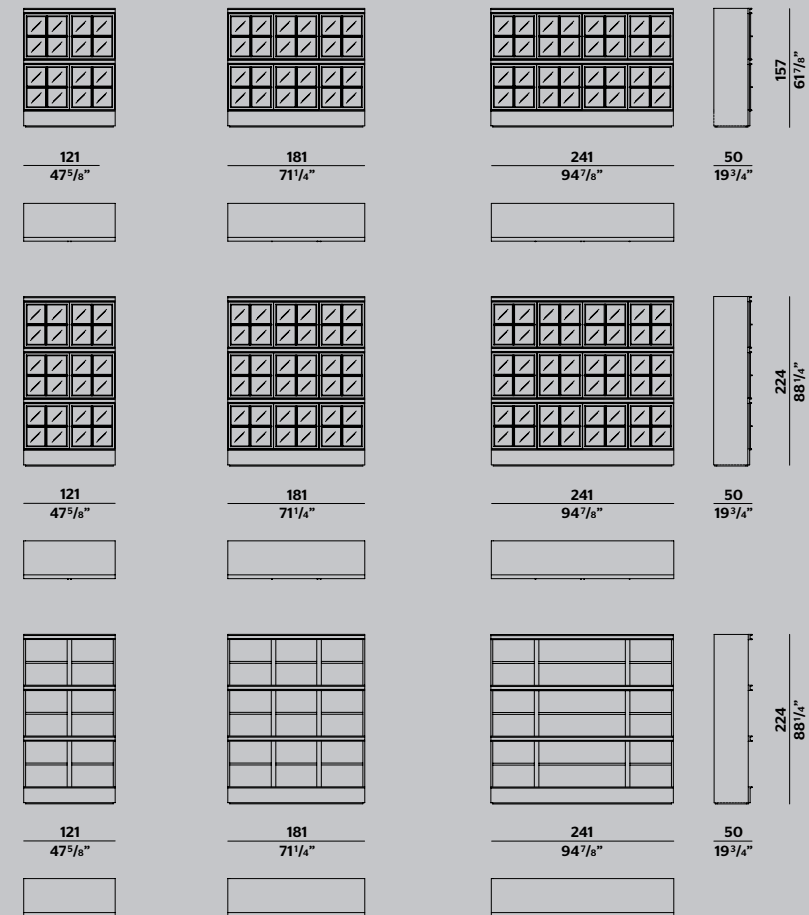

D.950.1 GIO PONTI

FRAMED MIRRORS
CORNICI CON SPECCHIO

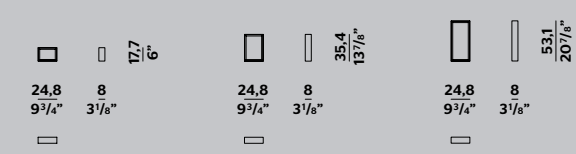

HECTOR MIRROR VINCENT VAN DUYSSEN

MIRRORS
SPECCHIERE

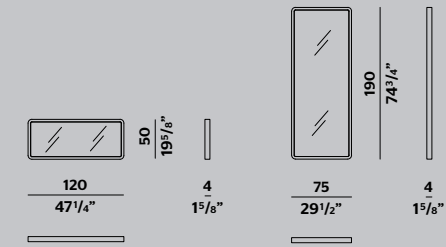

D.754.1 GIO PONTI

CARPET
TAPPETO



ATALANTE by Ruckstuhl NICOLA GALLIZIA

CARPETS
TAPPETI

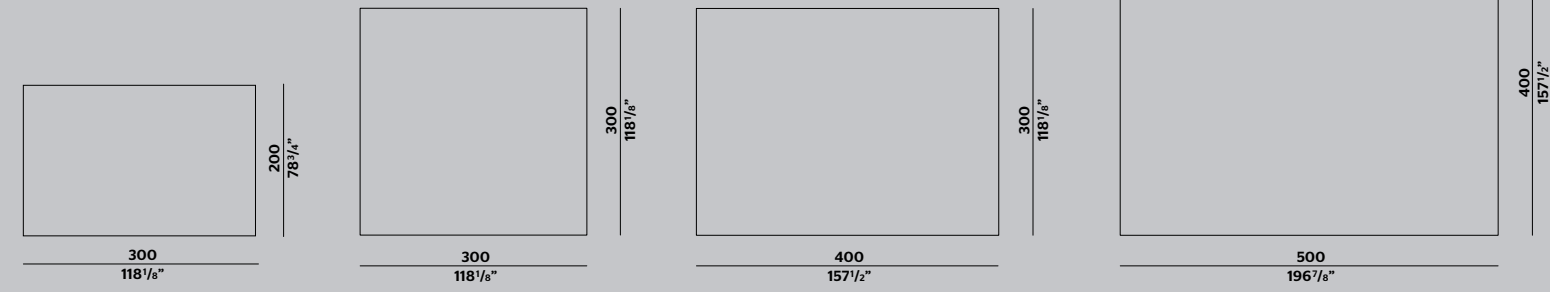

CORBA MARTA FERRI

CARPETS
TAPPETI

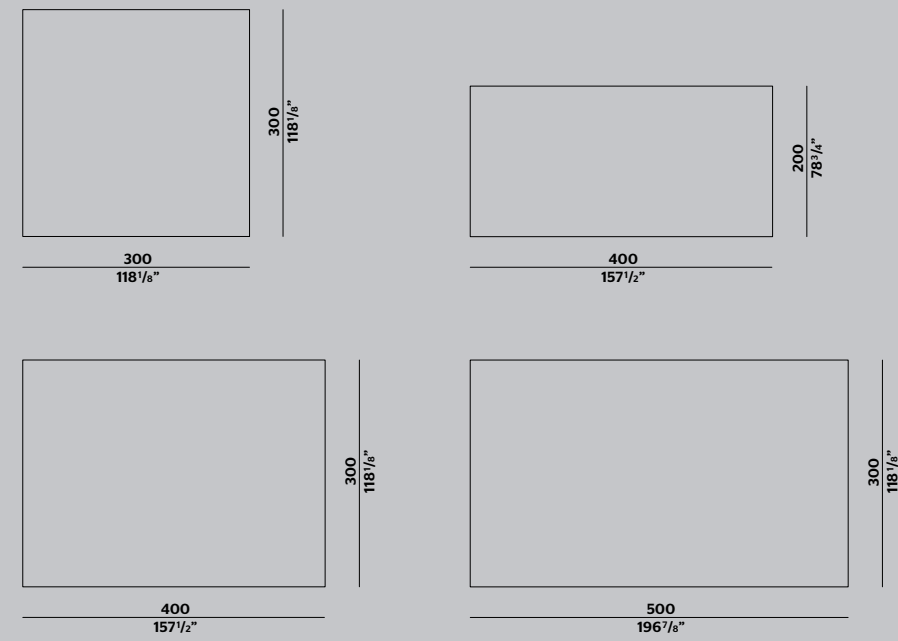

DEDALO by Pierre Frey MARTA FERRI

CARPETS
TAPPETI

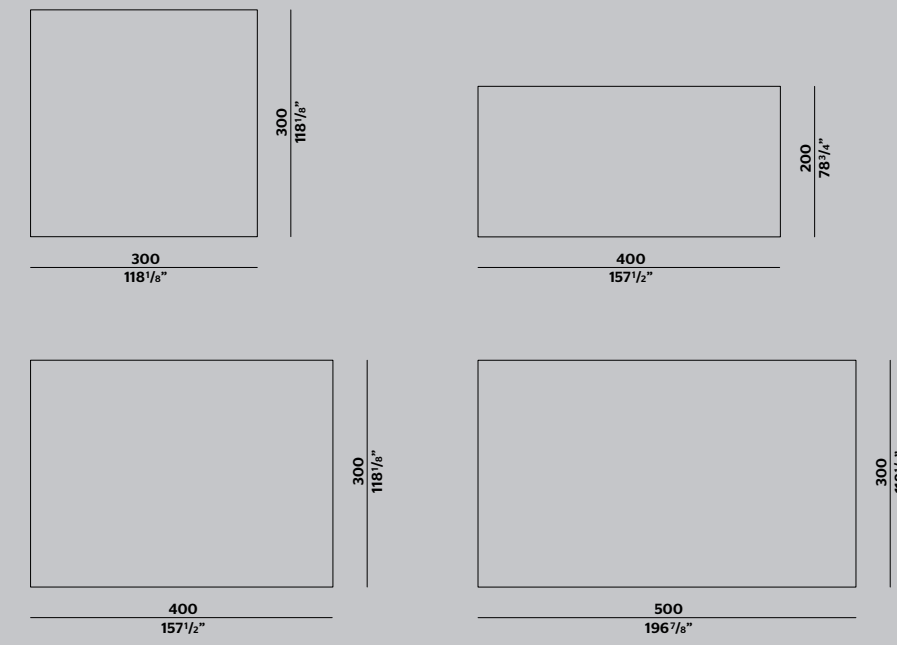

DUNA NICOLA GALLIZIA

CARPETS
TAPPETI

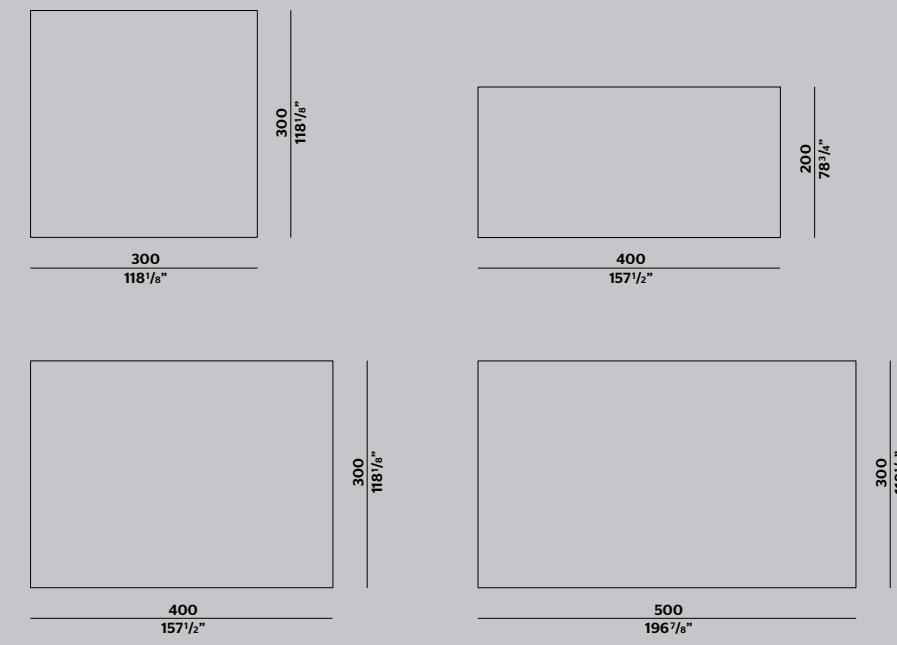

EDGE NICOLA GALLIZIA

CARPETS
TAPPETI

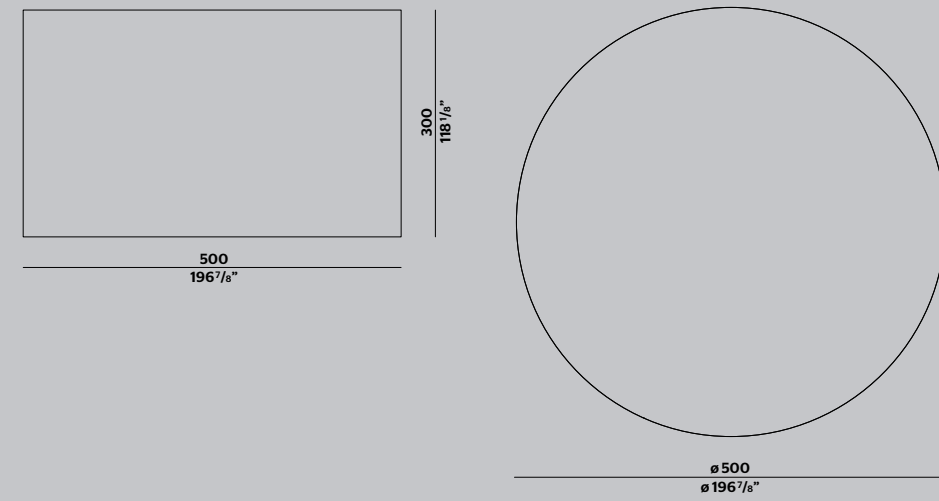
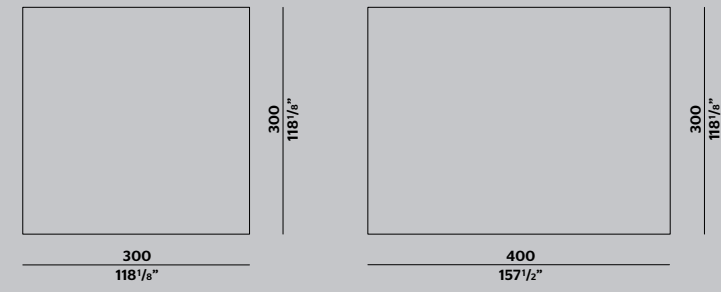

HEM by G.T.Design PATRICIA URQUIOLA

CARPETS
TAPPETI

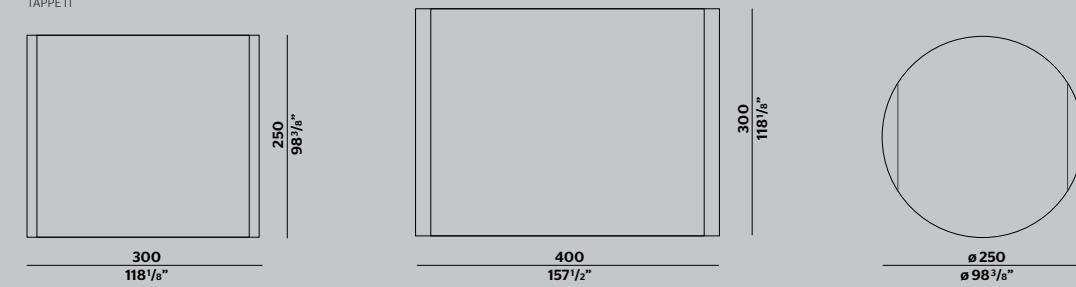

LOOP&CUT by G.T.Design PATRICIA URQUIOLA

CARPETS
TAPPETI

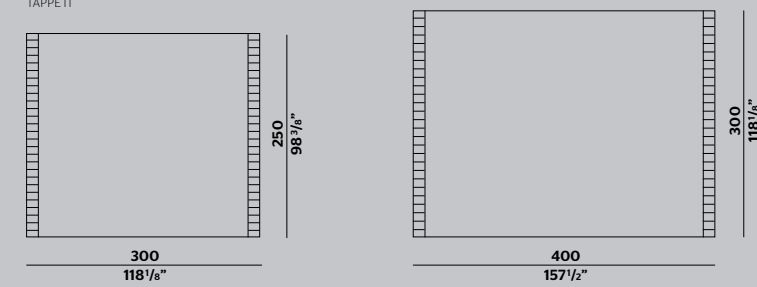

PALETTE NICOLA GALLIZIA

CARPETS
TAPPETI

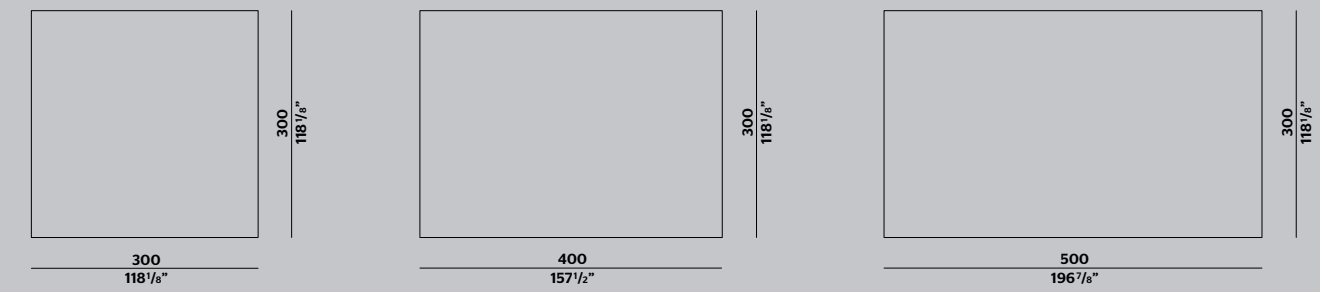

RANDOM by Altai PATRICIA URQUIOLA

CARPETS
TAPPETI

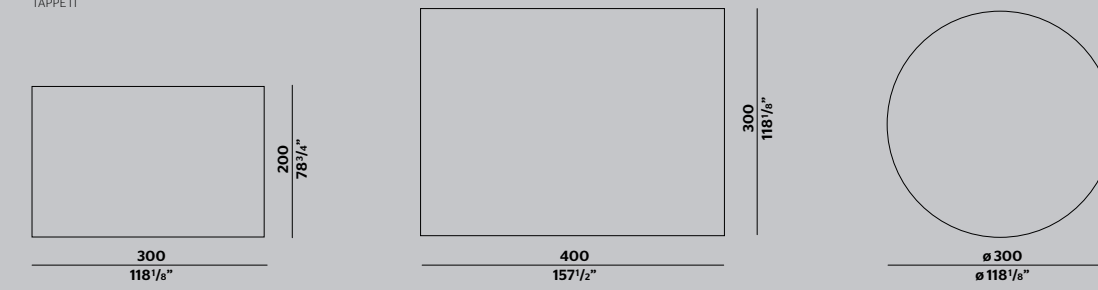

STRIPE VINCENT VAN DUYSSEN

CARPETS
TAPPETI

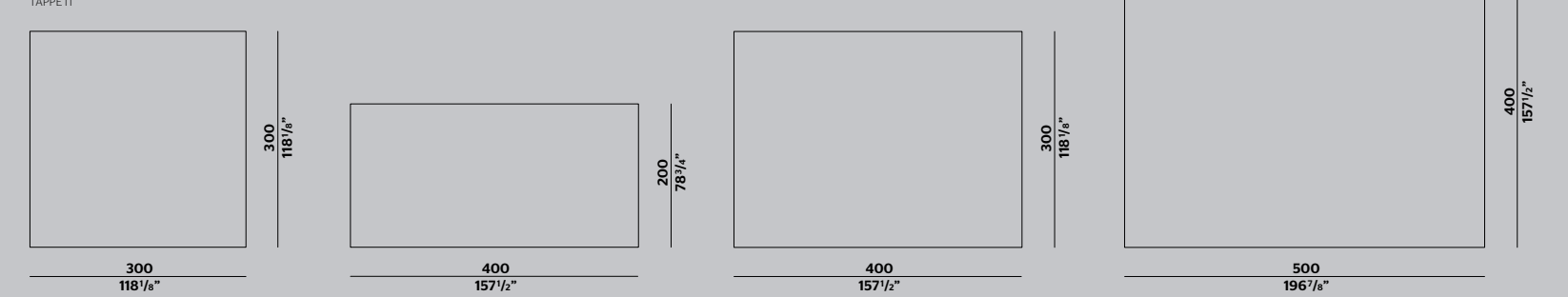

TELARO by Amini MARTA FERRI

CARPETS
TAPPETI

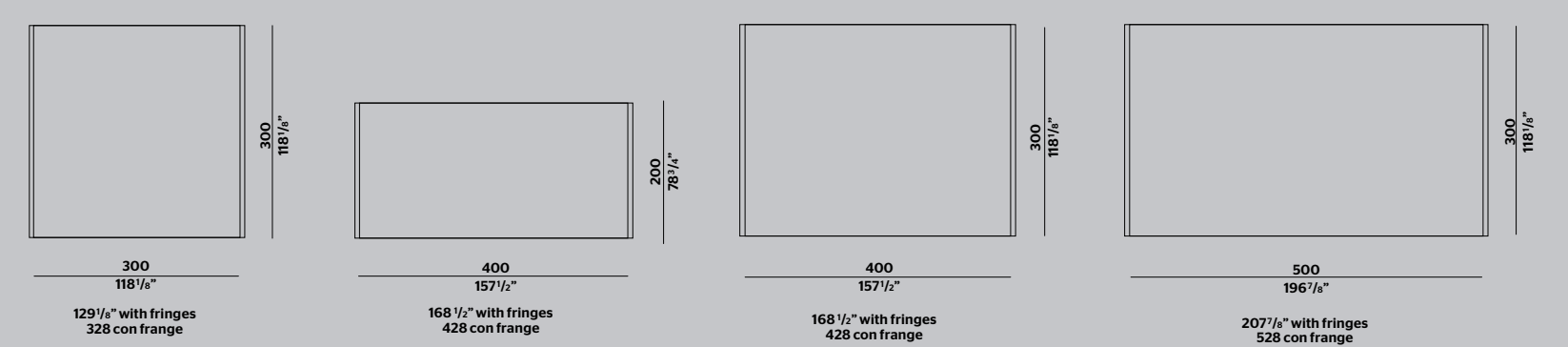

AURA NICOLA GALLIZIA

CARPETS
TAPPETI

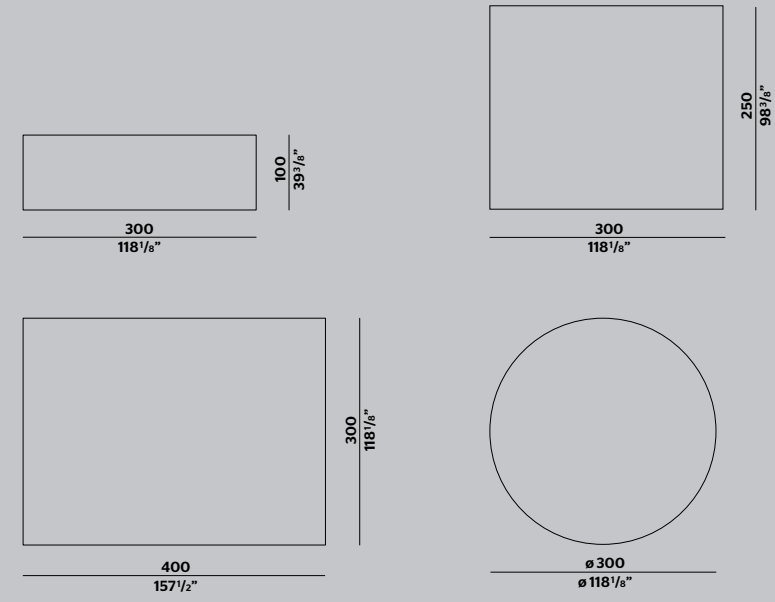

MOSAICO MARTA FERRI

CARPETS
TAPPETI

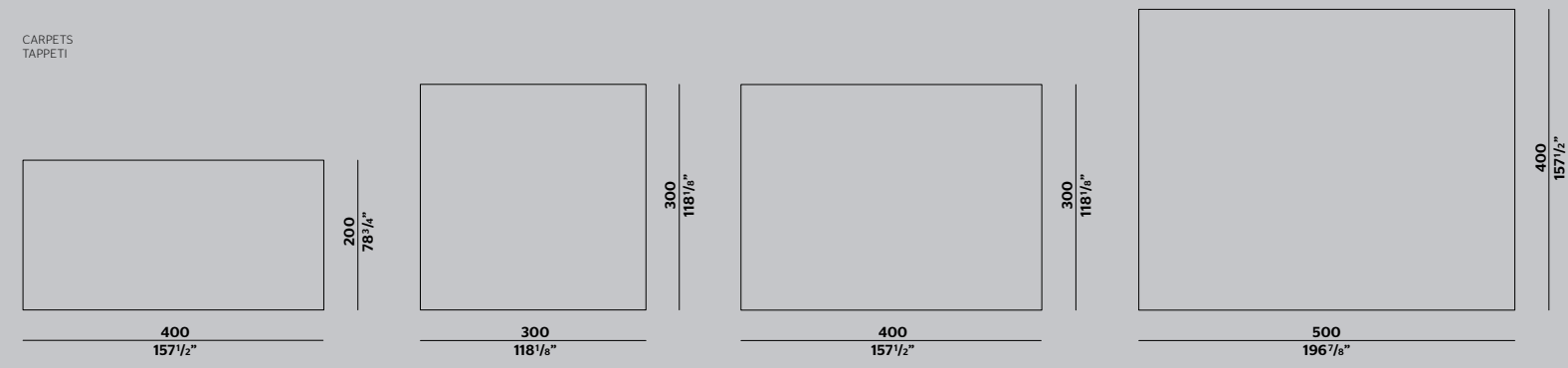

VIBRAZIONI MARTA FERRI

CARPETS
TAPPETI

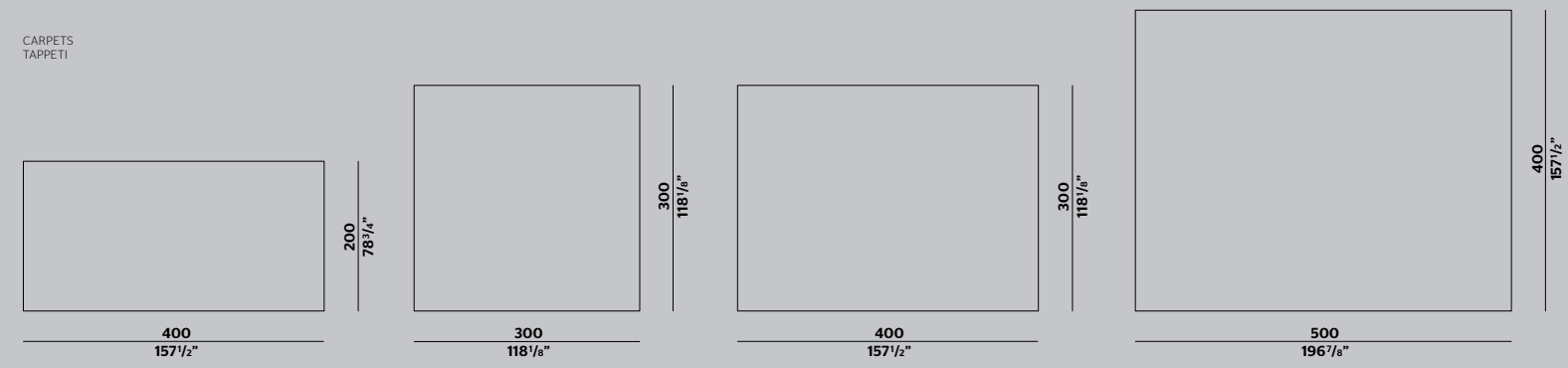

AD—

VINCENT VAN DUYSEN

STYLING—

ALESSANDRO PASINELLI STUDIO
ELISA OSSINO STUDIO

PHOTO—

MAX ROMMEL
TIZIANO SARTORIO
FILIPPO PIANTANIDA
MAX ZAMBELLI
ARMANDO BERTACCHI
VITTORIO DOZIO

PHOTO 2022/23 THANKS TO—

JOEL DENOT/ MODESTIPERDRIOLLE GALLERY
KALPA ART LIVING GALLERIES
MARCO SOLZI PAINTINGS
YASMIN BRANDOLINI D'ADDA

PLH
MOTTURA
MARAZZI

1+1 GALLERY
ALBA GALLIZIA
ARTEK
ARTEMIDE
ASTEP
BRUNELLO CUCINELLI
CTO LIGHTING
ENRICO DONADELLO
ESTILUZ
FEDERICA BUBANI
GALLERIA AFRICA CURIO
GALLERIA GIUSTINI / STAGETTI, ROMA
GALLERIA MICHELA CATTAI
KLASSIK STUDIO
KRISTINA DAM
LUCEPLAN
LUMINA
MICHELE REGINALDI
NEMO LIGHTING
NILUFAR GALLERY
OLUCE
RINA MENARDI
RIVIERE
SALVATORE FERRAGAMO
SANTA&COLE
SEASE



MADE
IN
ITALY



moltenigroup.com
moltenimuseum.com
#MolteniGroup
#MolteniMuseum



@MolteniandC



Molteni&C



@MolteniandC



@MolteniandC



@MolteniandC



@MolteniandC



Molteni&C



MolteniC



@MolteniandC



Dining

