

**OUTDOOR
COLLECTION**



FRITZ HANSEN





CONTENTS

6

ABOUT
Conscious Design Crafted with Care

14

PORTFOLIO
Outside the Ordinary

86

MATERIALS
From Nature with Love

98

COLLECTION
Made to Stand Out



Textile: Light Sand

ABOUT

Conscious Design Crafted with Care

Explore our extensive range of
consciously designed outdoor furniture.
Contemporary design crafted with care,
certified wood and textiles.

We promise they will bring you
comfort and joy - because they are
made to love and made to last.

The Fritz Hansen outdoor collection elevates modern living outdoors while expressing the Nordic connection between nature and design.

The collection contains pieces known for their functionality, durability and relevance over the decades – and new designs yet to write history.



Textile: Honey Yellow

ABOUT

Made to Love and Made to Last

The Fritz Hansen outdoor collection is contemporary wooden furniture designed to last a lifetime. Material choice and the possibility of repair are essential to ensuring longevity. Each piece is crafted with care using honest, durable materials that age with beauty.



Textile: White



Co-created with renowned architects and designers, the design language of the collection originates from Danish functionalism and woodcraft traditions in outdoor furniture, transformed into contemporary and relevant pieces.

This approach has expanded beautiful design beyond the indoors to meet modern living needs in outdoor spaces. The outdoor collection is contemporary wooden furniture crafted with care. All of the teak in our outdoor furniture is FSC™-certified.

PORTFOLIO

Outside the Ordinary

Introducing the extraordinary outdoor collection by Fritz Hansen. Explore consciously designed outdoor furniture in certified wood and durable materials, crafted to last a lifetime.



Textile: Sea Blue Stripe

LOUNGE

Relax in Outdoor Comfort

Outdoor sofas and lounge chairs
invite immersive relaxation and
comfort to garden and terrace spaces.



Tradition

Nature just got comfortable with the Tradition outdoor lounge series by Povl B. Eskildsen. Conscious design, crafted with care using certified wood, textiles, and honest, durable materials that naturally age with grace. Made to love, made to last.





Textile: Light Sand





Textile: Charcoal



Tradition's wood is naturally durable with cushions made to withstand all weather conditions. Untreated teak will patinate over time to reveal a beautiful silver-grey colour. Tradition is designed to provide an exquisite outdoor lounging experience like no other for years to come.



Pelagus

Perfectly at home on a leafy porch or by the pool on a hotel terrace, the graceful contemporary expression of the Pelagus series sits lightly and offers high comfort. Designed in collaboration with Stockholm-based NOTE Design Studio.

“Whenever I picture this furniture collection outdoors in nature or wherever, it should feel that it just lands there with ease and grace in the sense of not being from a discernible period.”

NOTE DESIGN STUDIO AND
SUSANNA WÄHLIN, INTERIOR
ARCHITECT/ PARTNER





Textile: Golden Yellow Stripe

Virkelyst

Clean lines, discreet details, high comfort. The thick, soft and comfortable cushions in Virkelyst are made for relaxing for hours in sunny spaces.







Between Lines

Crafted with comfort, quality and durability in mind, Between Lines deck chair and stool has a restful expression, perfect for enjoying life slowly in the great outdoors. Designed in collaboration with Danish designer Stine Weigelt.



Banco



“I wanted to make it as pleasant as possible for people to enjoy the nature. The sun moves so the double bench can be used on either side and while seeking to design a backrest for comfort I also tried to achieve beauty.

HUGO PASSOS,
DESIGNER



Lilium

The Lilium series is a contemporary take on outdoor furniture designed by the renowned Bjarke Ingels Group (BIG) architects. Made of just two materials: teak and stainless steel, Lilium is long-lasting furniture perfect for outdoor events and gatherings.

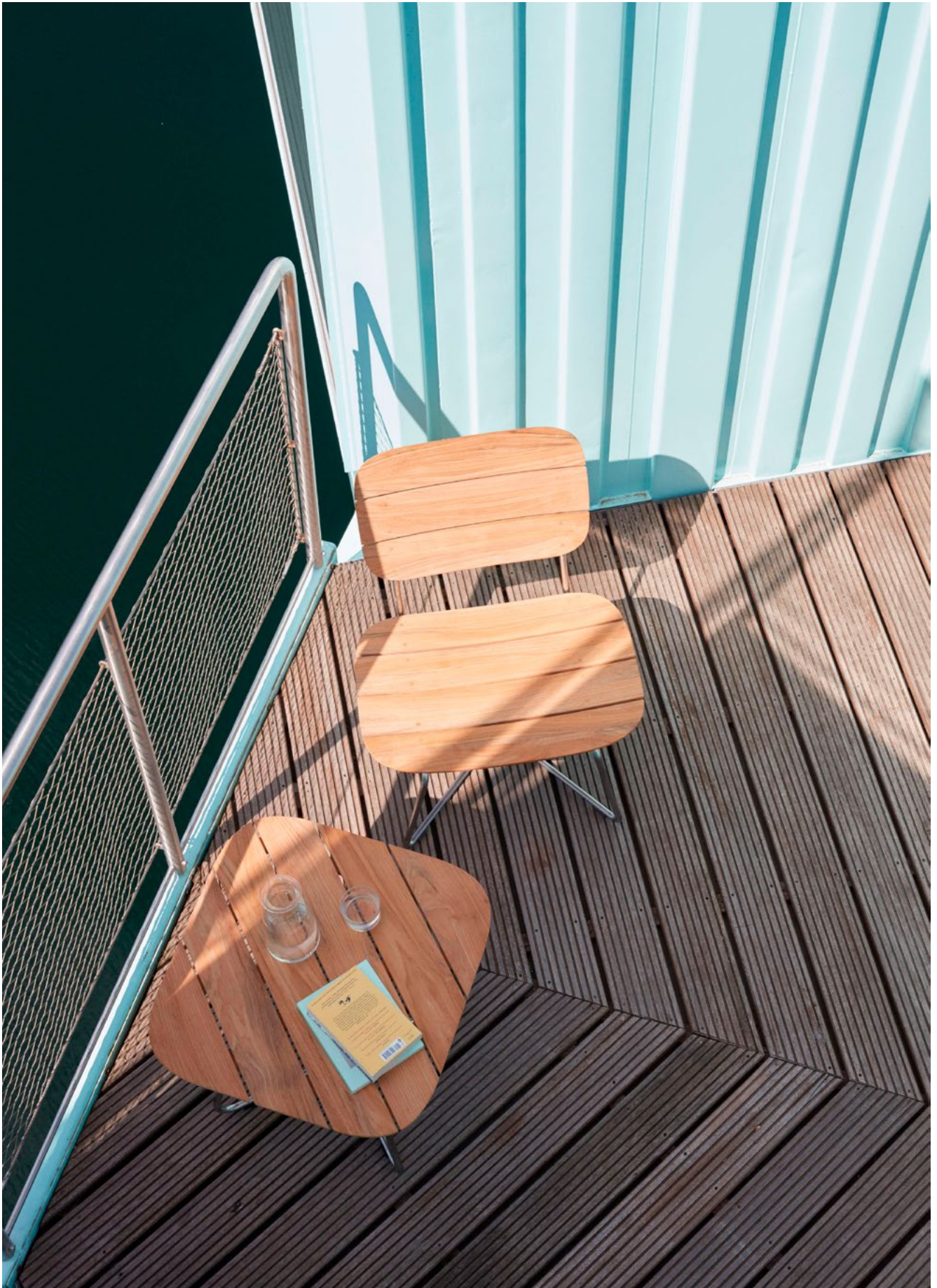



Textile: Light Apricot/Dark Green Stripe



Cutter

The iconic Cutter bench and stool in teak are minimalistic, functional and eye-catching designs for everyday outdoor and indoor use. Designed in collaboration with Danish designer, Niels Hvass.



DINING

Outdoor Gatherings

Turn meals into memories under
the open sky with finely crafted
outdoor tables and chairs.



Drachmann

Designed in collaboration with Danish designers, Mogens Holmriis and Bernt Santesson, the balanced forms of the Drachmann series of tables and seating pairs Nordic nostalgia with modern simplicity.









Selandia

Selandia's signature slight curves and elegant Nordic look with subtle French references that hint at long summer nights in the open air.







Colour: Hunter Green

Pelagus

Designed for sociability and comfort, the extendable Pelagus table can comfortably seat 6-8 people, with optional extension plates adding up to four more. The table and chairs are crafted to last with teak and powder-coated aluminium.



Lilium

Inspired by the shape of a lily pad and crafted in teak and stainless steel, the sturdy yet lightweight Lilium series offers a contemporary and elegant dining experience.



Textile: Off-White



Plank

Plank outdoor series by contemporary Parisian designer Aurélien Barbry, is characterised by simplicity and functional beauty. An architectural repetition lends the Plank series a clean and modern elegance.

“I think design is an exercise where you take the simplest things in your daily life and ask yourself how they could be done differently.”

AURÉLIEN BARBRY,
DESIGNER





Colour: Hunter Green



Overlap

Overlap series stands strong on its overlapping steel legs. Rustic wooden planks of solid western red cedar and powder-coated steel gives the series a modern edge and contemporary appeal. Perfect for both indoor and outdoor dining. Overlap is designed in collaboration with Swedish architecture studio TAF.



Ballare

Ballare is crafted for lasting beauty. Blurring the lines between indoor and outdoor living, the minimalist designs feature soft curves and considered details that make them a delight to look at as well as to use. Two table extension pieces are included. Designed by Danish designer Jakob Berg.





Skagen

Drawing inspiration from the natural beauty of northern Denmark, the Skagen series is an open invitation to elegant outdoor dining.

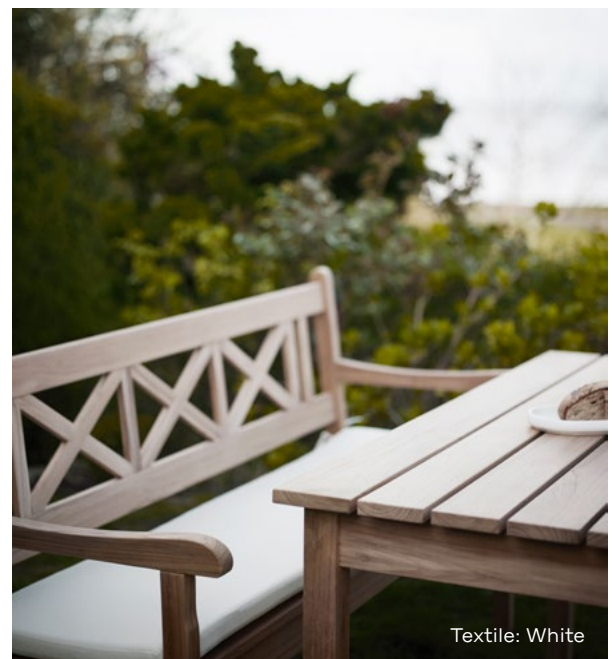

Textile: White



Vendia

Made with smaller spaces in mind, Vendia series delivers the elegance of traditional outdoor furniture in a scaled-down design. Ideal for balconies, patios and terraces where space is at a premium.



Reform

A classic – yet modern look – in powder-coated aluminium and untreated teak that pairs easily with other outdoor furniture. Reform brings together industrial and natural elements in a classical design where small details such as the visual fittings on the sides stand out. Designed in collaboration with Swedish designer Louise Hederström.





SUNLOUNGING

Relax in the Sun

Enjoy a comfortable
sunchair or sunbed. Crafted
to last year after year.

Pelagus



Textile: Honey Yellow

“Whoever you are and wherever you are, at home or in a hotel in LA, Italy or Morocco, when you lie down on the sunbed you just want that relaxed laidback feeling.”

NOTE DESIGN STUDIO AND SUSANNA WÄHLIN,
INTERIOR ARCHITECT/ PARTNER









Riviera

Renowned for its flexibility and straightforward appearance, Riviera transforms to suit myriad purposes. The ingenious construction is adjustable by design in both expression and functionality. Add a cushion for extra comfort. Designed in 1991 with Danish designer Povl B. Eskildsen.



Textile: Golden Yellow Stripe



Steamer

The perfect spot to recline and relax in the Steamer Deck Chair, a modern rendition of the archetypal sun lounger.



Columbus

The Columbus Sunbed is shaped from solid teak with wonderfully comfortable SunTexture fabric. Stable and durable, its back wheels make it easy to move into the sun or shade, while the backrest is adjustable to multiple positions.



Colour: Dark Blue Stripe

UMBRELLAS

Stay Cool in the Shade

Beautiful, durable umbrellas
crafted from long-lasting materials that
can withstand all kinds of weather.



Textile: Off-White

Messina

Crafted from long-lasting lacquered kapur wood and with a clean design, Messina will protect from the sun, shading hot summer days for many years to come.



Textile: Off-White





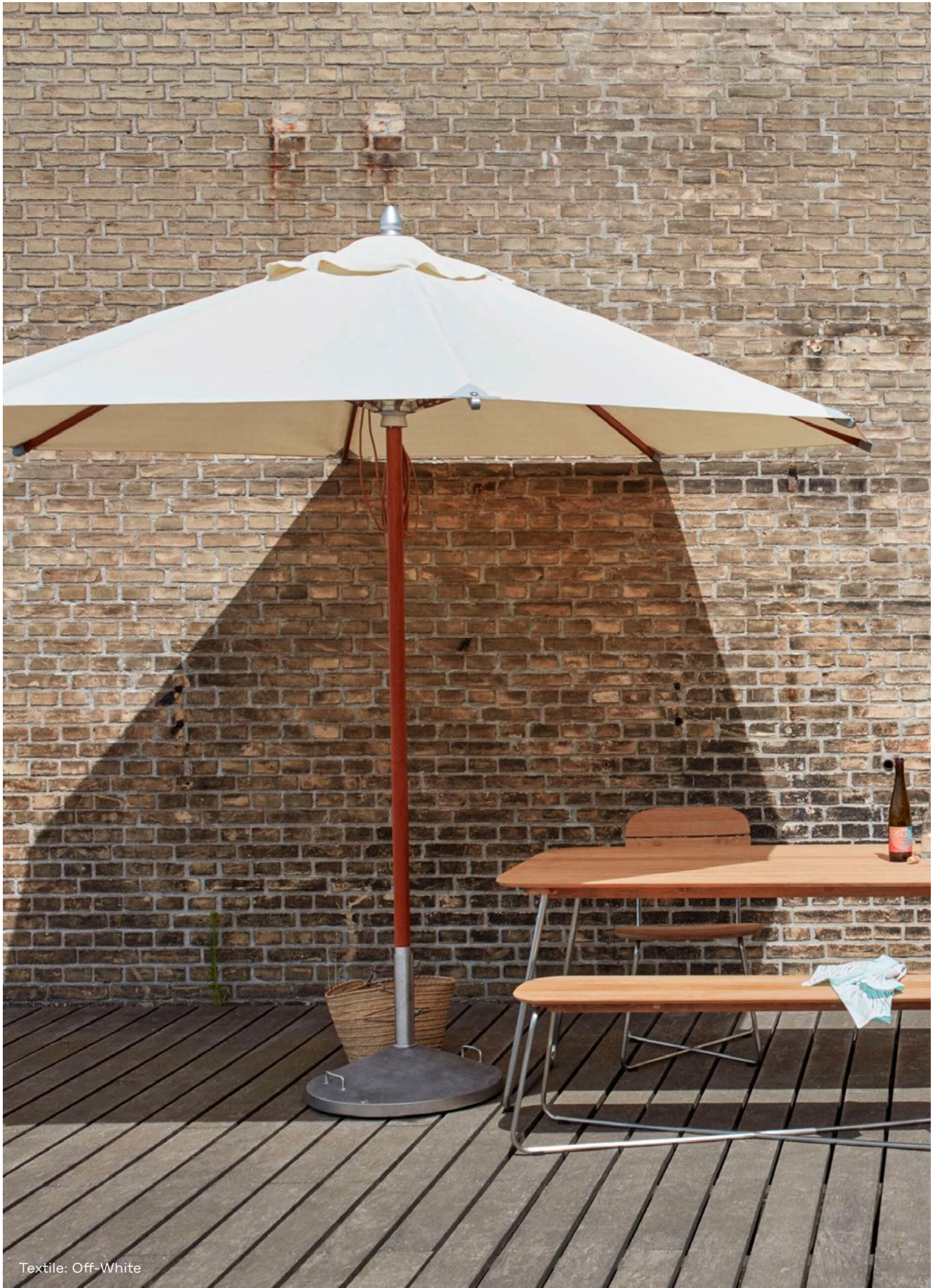

Textile: Off-White



Atlantis

Leather-reinforced textile for extra strength and aluminium reinforced pole to protect the wood from wear and scratches. A double pulley system makes it easy to everyone to fold up the Atlantis umbrella series.



Catania

The elegant Catania umbrella provides shade in a beautiful form. Crafted from long lasting materials, stay cool during hot summer days this year and for years to come.



Textile: Off-White



ACCESSORIES

Elevating Atmospheres

Accessories made to transform
outdoor spaces with functional
and beautiful design.





Spider Web

With a look reminiscent of a spider's snare, the Spider Web Drying Rack shares the strength and beauty of nature's artistry. The five-legged frame is crafted in teak, a durable and hard wood that stands up to the elements. Designed by Danish designer Anders Brøgger.



Pantry

Pantry series offers versatile storage solutions for indoor and outdoor living. The portable designs in durable teak, natural limestone tops and slatted shelves offer extra surface space for cooking, potting plants or simply storing useful items close to hand.





Barriere

Weather-resistant and beautiful pillows and cushions that are made to live under an open sky, day and night. All pillows and cushions are all made in weather resistant textiles that are incredibly colour- and lightfast as well as water and dirt repellent.





Fionia Tray



Dania Mat



Norr Paper Towel Holder



Transform outdoor spaces with beautiful, practical, and functional objects originally crafted for indoor use – made with strong and durable materials, ensuring that they can be brought outside.

MATERIALS

*From Nature
with Love*

Material choice and the possibility of repair are essential to ensuring longevity. Each piece in the outdoor collection is made with honest, durable materials that age beautifully. Responsible materials like certified wood and certified textiles made without harmful chemicals are preferred and used in most pieces.

TEAK

For the Love of Wood

We use teak for most of our outdoor furniture, as it requires little care and maintenance. All of the teak in our outdoor furniture is FSC™-certified. The high content of natural oils makes the teak highly weather and rot resistant and is, therefore, an excellent choice for outdoor furniture. We only use core teak because it is richer in natural oils making it evenly grained, more weather resistant and longer lasting than the outer teak wood.

Teak is a heavy, hard and sturdy wood type but also an organic material. Teak wood will naturally expand and contract with changes in temperature and humidity and small cracks or scratches can occur at temperature or weather changes. Remember to re-tighten the fittings from time to time.







From left to right:
New (untreated), 1 year (untreated), 2 years (untreated), Oiled

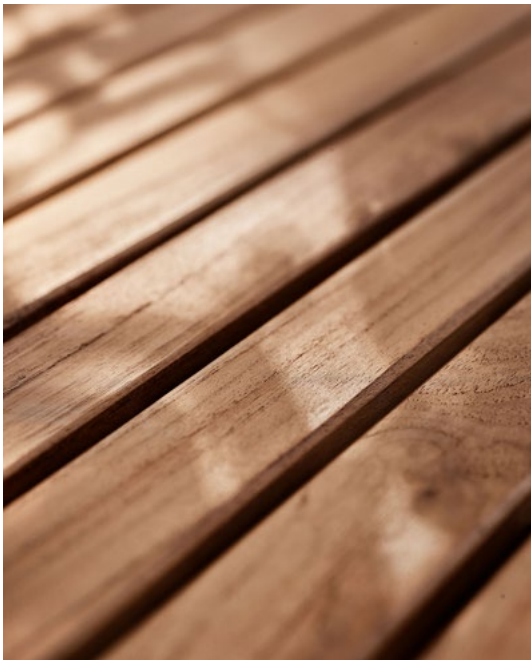

Brand new teak furniture has natural colour differences found in the freshly cut wood. Once the furniture has been exposed to the sun, these colour differences will even out. As a natural part of the aging process, the surface of teak will change when first exposed to rain; this is the primary stage of a process of wood that ages beautifully over time.

The easiest way to maintain teak is to leave it untreated. This does not affect the durability or quality of the furniture. Untreated teak will develop a patina over time and eventually become a beautiful silvery-grey colour.

It is important to prolong the furniture's lifespan by cleaning it at least once a year. This will remove algae and dirt and make the furniture more resistant in all weathers, all year round. To preserve or intensify the original honey-golden colour of fresh teak, use a suitable furniture oil on a regular basis.

TEXTILES

For the Love of Design

Fritz Hansen's outdoor collection contains a range of high-quality outdoor textiles with suitable properties for outdoor use. All of our outdoor cushions and pillows are made to last – just like the furniture they are designed to accompany, adding comfort to the outdoor space.

Our range of textiles for cushions, pillows and umbrellas are designed to withstand every kind of weather. The textiles are extremely colour and lightfast, water and dirt-repellent and even mildew-resistant. The result is a smooth surfaces textile, pleasing to the touch.





CUSHIONS & PILLOWS

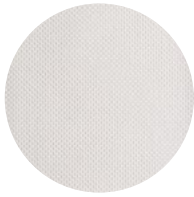

White



Ash



Charcoal

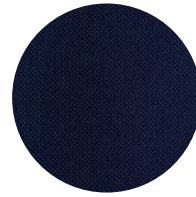

Marine



Golden Yellow
Stripe



Sea Blue
Stripe

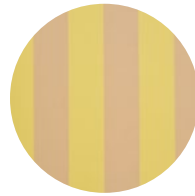

Lemon/Sand
Stripe



Light Apricot/
Dark Green Stripe



Honey
Yellow

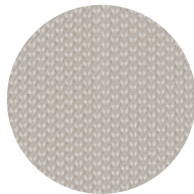

Light
Sand

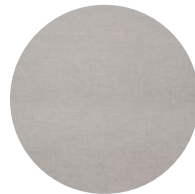

Papyrus

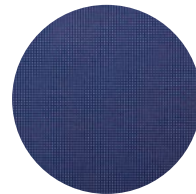

Sand/Dark Blue
Checker



Pick and choose from our range of different colours, styles and expressions to create your own look and feel for your outdoor spaces. Our textiles for outdoor cushions and pillows are Oeko-Tex® certified*.

*Does not include Lilium cushions
For details specific to UK/IE go to fritzhanen.com



UMBRELLAS



Off-White



Golden Yellow
Stripe



Dark Blue
Stripe



Lemon/Sand
Stripe



Light Apricot/
Dark Green Stripe

Stay cool in the shade with beautiful, durable umbrellas crafted from long-lasting materials. Water and stain resistant textiles with maximum sun protective rating (UPF50+), and wooden poles that can withstand wind and weather. Available in calm off-white colour or vibrant stripes variations.



COLLECTION

Made to Stand Out

The outdoor collection elevates modern living outdoors while expressing the Nordic connection between nature and design. The collection contains pieces known for their functionality, durability and relevance over the decades – and new designs yet to write history.

BALLARE

The Ballare series of elegant outdoor furniture is crafted for lasting beauty. Blurring the lines between indoor and outdoor living, the minimalist designs feature soft curves and considered details that make them a delight to look at as well as to use. Accommodating gatherings small and large, the table can be extended to almost three metres in length when using both of the included extension plates.



ARMCHAIR

Design: Jakob Berg
Material: Teak (FSC™ 100%)

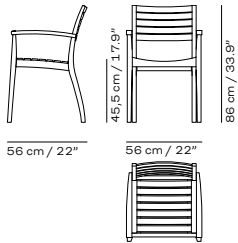

TABLE

Design: Jakob Berg
Material: Teak (FSC™ 100%)

Included:
2 x Extension plates

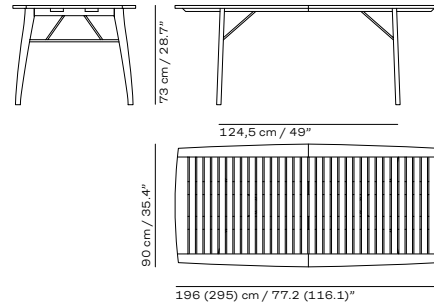

BANCO

Shaped for comfort and support, the Banco Bench was imagined to enhance the experience of the outdoors. Detailed with gentle curves that underscore the hand-crafted feel, it is made from FSC-certified teak which patinates to a beautiful silver-grey hue over time. The bench provides plenty of space and comfort to sit and take in the beauty of nature.



BENCH

Design: Hugo Passos
Material: Teak (FSC™ 100%)

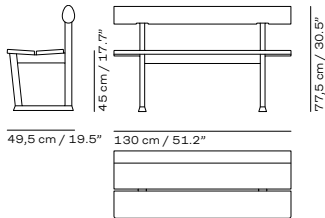

BENCH DOUBLE

Design: Hugo Passos
Material: Teak (FSC™ 100%)

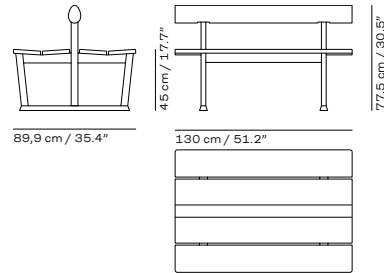

BARRIERE

The Barriere series is a range of beautiful cushions designed to make seating experiences better and softer. Designed for all weather conditions, the cushions are made to last year after year with resilient and weatherproof materials. Bring extra soft comfort to outdoor seating in a range of eye-catching colours, patterns and sizes.



SEAT CUSHION 43×43
 Design: Skagerak Design
 Material: Outdoor textile / Kapok

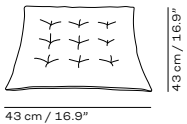

SEAT CUSHION 55×43
 Design: Skagerak Design
 Material: Outdoor textile / Kapok

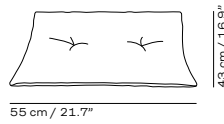

SEAT CUSHION 125×43
 Design: Skagerak Design
 Material: Outdoor textile / Kapok

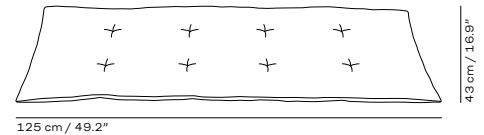

DECORATIVE PILLOW 50×40
 Design: Skagerak Design
 Material: Outdoor textile / Fibre Filling

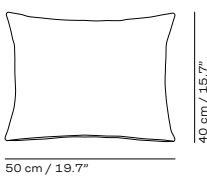

DECORATIVE PILLOW 60×50
 Design: Skagerak Design
 Material: Outdoor textile / Fibre Filling

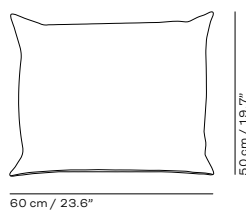

DECORATIVE PILLOW 80×50
 Design: Skagerak Design
 Material: Outdoor textile / Fibre Filling



BETWEEN LINES

Made with comfort, quality and durability in mind, the Between Lines series has a restful expression which makes it perfect for enjoying life slowly in the great outdoors. Designed by Danish furniture designer Stine Weigelt. Natural in both function and design, the Deck Chair is a modern take on the American Adirondack. It features long, angular lines that are perfectly positioned for comfort.



DECK CHAIR

Design: Stine Weigelt
Material: Teak (FSC™ 100%)

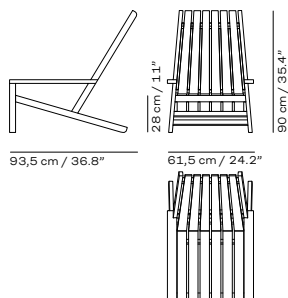

DECK CHAIR CUSHION

Design: Stine Weigelt
Material: Outdoor textile / Quickdry outdoor foam

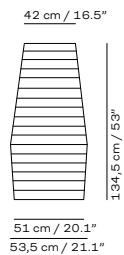

DECK STOOL

Design: Stine Weigelt
Material: Teak (FSC™ 100%)

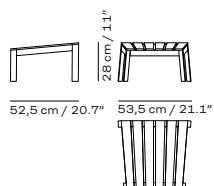

COLUMBUS

The Columbus series takes its design cues from traditional American-style garden chairs. Pared back to a simpler, Scandinavian expression with slatted seats and visible fittings, the series is equally suited to al fresco dining or relaxing on a sunny terrace.



CHAIR

Design: Skagerak Design
Material: Teak (FSC™ 100%)

Adjustable

SUNBED

Design: Skagerak Design
Material: Teak (FSC™ 100%) / SunTexture

Adjustable

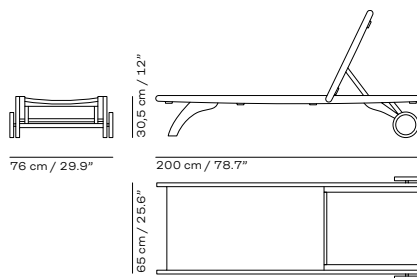
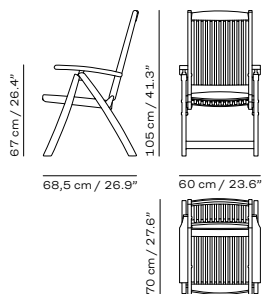

CUTTER

The iconic Cutter series is a minimalistic and functional design. Inspired by the German Bauhaus movement, the series contains many options and combinations giving a wonderful array of choice to suit many places.

Note: Only the teak bench and stool are suitable for outdoor use. Other variants are only for indoor use.



STOOL

Design: Niels Hvass
Material: Teak (FSC™ 100%)

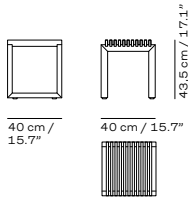

BENCH

Design: Niels Hvass
Material: Teak (FSC™ 100%)

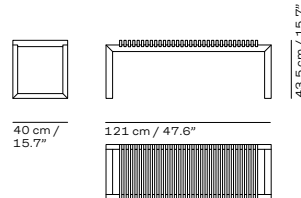

DRACHMANN

The signature Drachmann series draws inspiration from the beautiful garden of Danish romantic poet and painter, Holger Drachmann. A careful balance of Nordic nostalgia and modern simplicity underlies its enduring popularity.



CHAIR

Design: Bernt Santesson
Material: Teak (FSC™ 100%)

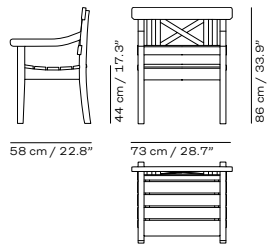

CHAIR CUSHION

Design: Skagerak Design
Material: Outdoor textile / Quickdry outdoor foam

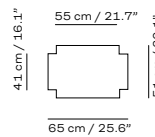

BENCH 120

Design: Bernt Santesson
Material: Teak (FSC™ 100%)

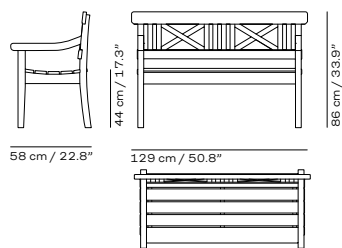

BENCH CUSHION 120

Design: Skagerak Design
Material: Outdoor textile / Quickdry outdoor foam

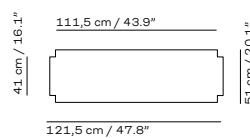



BENCH 165

Design: Bernt Santesson
Material: Teak (FSC™ 100%)

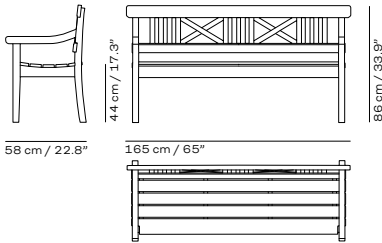

BENCH CUSHION 165

Design: Skagerak Design
Material: Outdoor textile / Quickdry outdoor foam

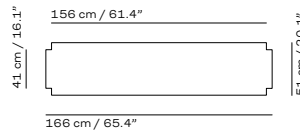

BENCH 200

Design: Bernt Santesson
Material: Teak (FSC™ 100%)

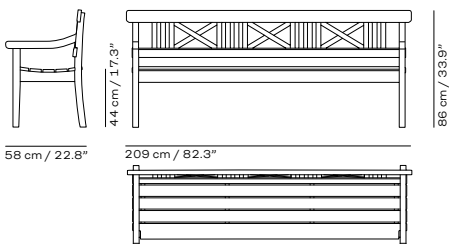

BENCH CUSHION 200

Design: Skagerak Design
Material: Outdoor textile / Quickdry outdoor foam

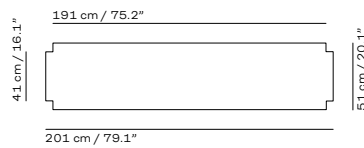

DRACHMANN

The signature Drachmann series draws inspiration from the beautiful garden of Danish romantic poet and painter, Holger Drachmann. A careful balance of Nordic nostalgia and modern simplicity underlies its enduring popularity.



TABLE Ø126
 Design: Mogens Holmriis
 Material: Teak (FSC™ 100%)

TABLE 86
 Design: Mogens Holmriis
 Material: Teak (FSC™ 100%)

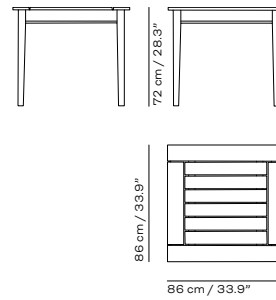
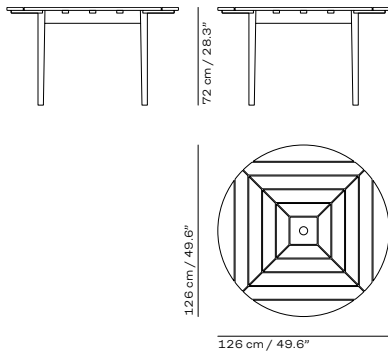
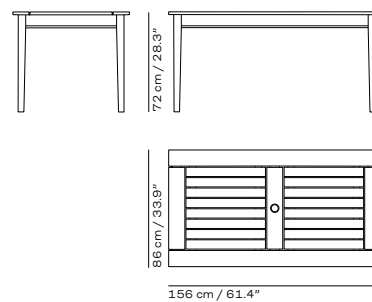
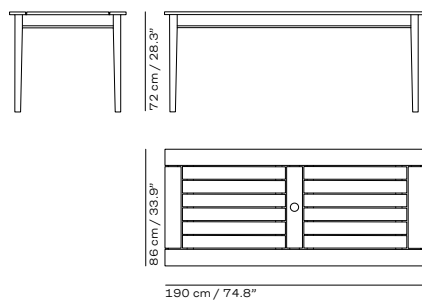

TABLE 156
 Design: Mogens Holmriis
 Material: Teak (FSC™ 100%)

TABLE 190
 Design: Mogens Holmriis
 Material: Teak (FSC™ 100%)



ENGLAND

Looking to the wooden benches found in parks and gardens across Britain, the England Series is a modern interpretation of a classic design, complete with comfortable contours and a sturdy and durable construction. A comfortable garden seat for up to four people.



BENCH 152

Design: Skagerak Design
Material: Teak (FSC™ 100%)

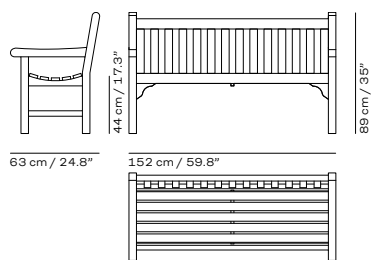

BENCH 180

Design: Skagerak Design
Material: Teak (FSC™ 100%)

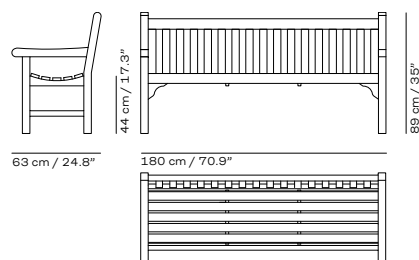

LILIUM

The Lilium collection is a contemporary take on outdoor furniture that also sits wonderfully indoors. Designed by renowned BIG – Bjarke Ingels Group – Lilium is long-lasting furniture perfect for outdoor events and gatherings.



ARMCHAIR

Design: BIG – Bjarke Ingels Group
Material: Teak (FSC™ 100%) / Stainless steel

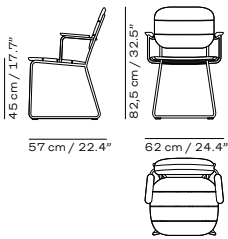

CHAIR

Design: BIG – Bjarke Ingels Group
Material: Teak (FSC™ 100%) / Stainless steel

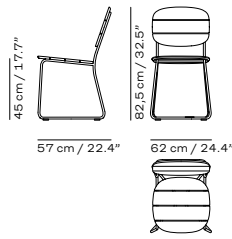

ARMCHAIR/CHAIR CUSHION

Design: BIG – Bjarke Ingels Group
Material: Outdoor textile / Neoprene



LOUNGE CHAIR

Design: BIG – Bjarke Ingels Group
Material: Teak (FSC™ 100%) / Stainless steel

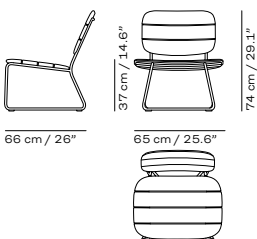

LOUNGE CHAIR CUSHION

Design: BIG – Bjarke Ingels Group
Material: Outdoor textile / Neoprene

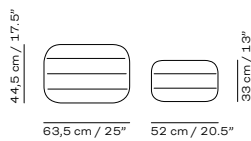



BENCH

Design: BIG – Bjarke Ingels Group
Material: Teak (FSC™ 100%) / Stainless steel

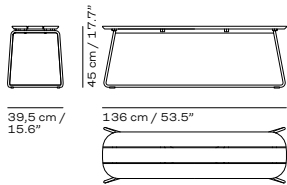

BENCH CUSHION

Design: BIG – Bjarke Ingels Group
Material: Outdoor textile / Neoprene

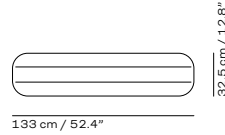

LOUNGE TABLE

Design: BIG – Bjarke Ingels Group
Material: Teak (FSC™ 100%) / Stainless steel

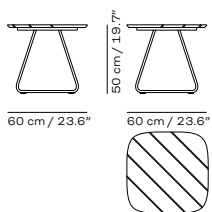

TABLE

Design: BIG – Bjarke Ingels Group
Material: Teak (FSC™ 100%) / Stainless steel

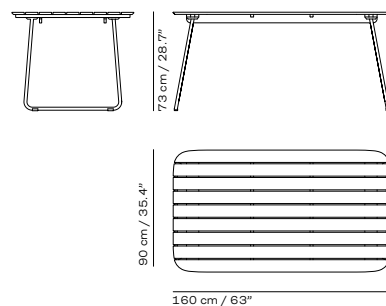

OVERLAP

Overlap series stands strong on its overlapping steel legs. Thanks to the rustic wooden planks and the powdercoated steel, the collection has a modern edge and contemporary appeal. Perfect for both indoor and outdoor use.



BENCH

Design: TAF Architects

Material: Western Red Cedar / Steel

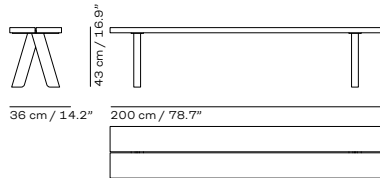

TABLE

Design: TAF Architects

Material: Western Red Cedar / Steel

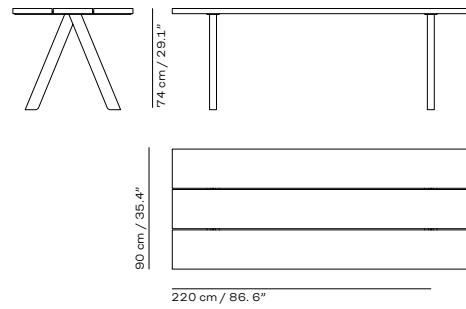

PANTRY

The Pantry series of freestanding shelving units offers versatile storage solutions for indoor and outdoor living. The portable designs in teak feature easy-clean, natural limestone tops and slatted shelves that offer extra surface space whether cooking, potting plants or simply storing useful items close to hand.



MODULE 1

Design: Maria Zachariae

Material: Teak (FSC™ 100%) / Limestone

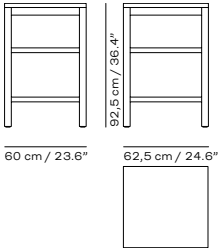

MODULE 2

Design: Maria Zachariae

Material: Teak (FSC™ 100%) / Limestone

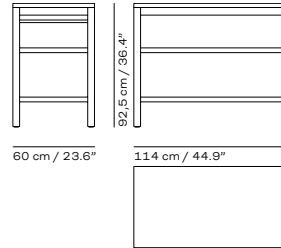

PELAGUS

Pelagus has a graceful contemporary expression that sits lightly in nature and holds its own in urban environments. The collection is high on comfort and versatility. It is furniture that suits a lifestyle as diverse as that lived in urban cosmopolitans or far from the city and grounded in nature.



ARMCHAIR

Design: NOTE Design Studio
Material: Teak (FSC™ 100%) / Aluminium

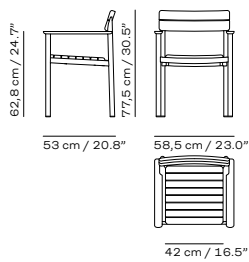

CHAIR

Design: NOTE Design Studio
Material: Teak (FSC™ 100%) / Aluminium

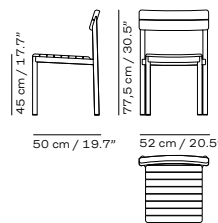

ARMCHAIR/CHAIR CUSHION

Design: NOTE Design Studio
Material: Outdoor textile / Quickdry outdoor foam

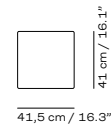

LOUNGE CHAIR

Design: NOTE Design Studio
Material: Teak (FSC™ 100%) / Sling textile

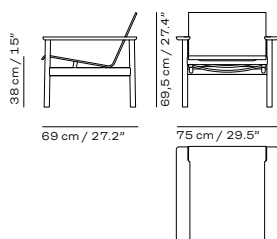

LOUNGE CHAIR CUSHION

Design: NOTE Design Studio
Material: Outdoor textile / Quickdry outdoor foam

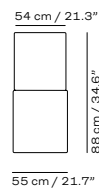



SUNBED

Design: NOTE Design Studio
Material: Teak (FSC™ 100%) / Sling textile

Add-on:
Sunbed armrest

SUNBED CUSHION

Design: NOTE Design Studio
Material: Outdoor textile / Quickdry outdoor foam

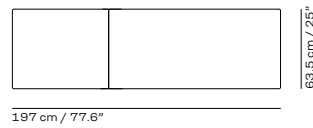
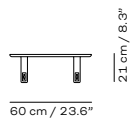
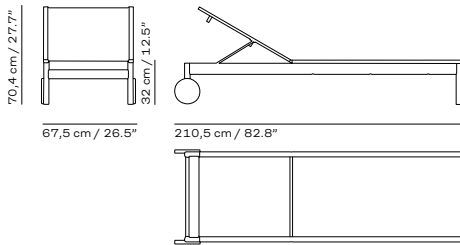

TABLE

Design: NOTE Design Studio
Material: Teak (FSC™ 100%) / Aluminium

Add-on:
Extension plate
(2 pcs.)

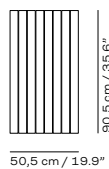
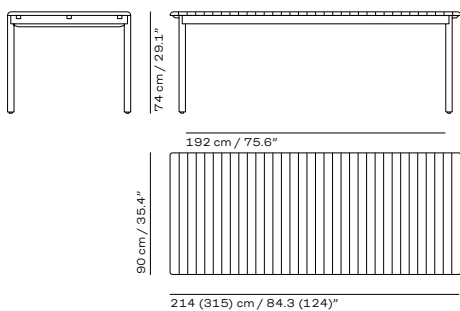

PLANK

Plank outdoor series by contemporary Parisian designer Aurélien Barbry, is characterised by simplicity and functional beauty. An architectural repetition lends the Plank series a clean and modern elegance.



CHAIR

Design: Aurélien Barbry
Material: Teak (FSC™ 100%)

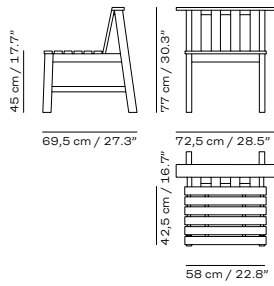

BENCH

Design: Aurélien Barbry
Material: Teak (FSC™ 100%)

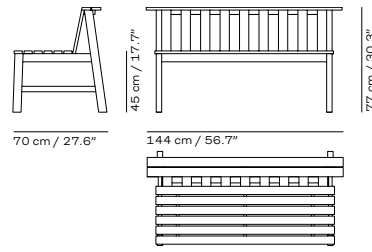

TABLE

Design: Aurélien Barbry
Material: Teak (FSC™ 100%)

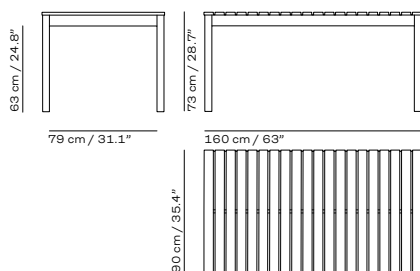

REFORM

The Reform series brings together industrial and natural elements in a classical design where small details such as the visual fittings on the sides stand out. The bench and table carries a simple but contrasting style which makes it highly compatible with other outdoor furniture in various materials and settings.



BENCH

Design: Louise Hederström

Material: Teak (FSC™ 100%) / Aluminium

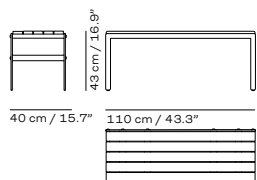

TABLE

Design: Louise Hederström

Material: Teak (FSC™ 100%) / Aluminium

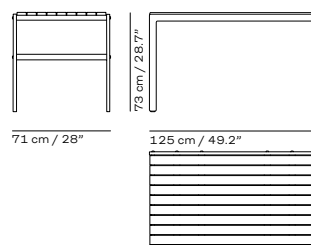

REGATTA

The Regatta Series of garden furniture profiles minimalist lines with soft curves that add character to outdoor spaces. Sink into the embracing comfort of the lounge chair or bench, expertly shaped with a captivating combination of curved and straight lines. Up the comfort level with the corresponding footstool and table.



LOUNGE CHAIR
 Design: Hans Thyge & Co.
 Material: Teak (FSC™ 100%)

LOUNGE BENCH
 Design: Hans Thyge & Co.
 Material: Teak (FSC™ 100%)

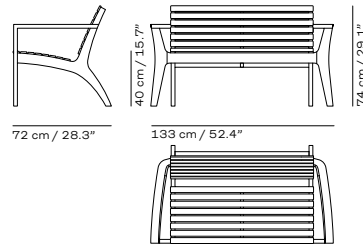
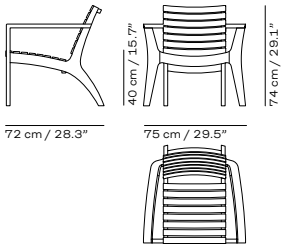

LOUNGE STOOL
 Design: Hans Thyge & Co.
 Material: Teak (FSC™ 100%)

LOUNGE TABLE
 Design: Hans Thyge & Co.
 Material: Teak (FSC™ 100%)

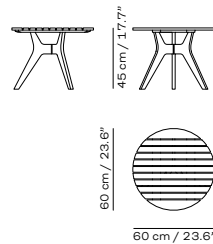
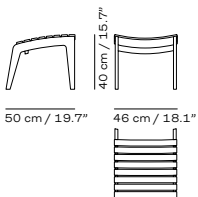

RIVIERA

Designed in 1991, the versatile Riviera Collection has become an outdoor classic, renowned for its flexibility and straightforward appearance. The ingenious construction is adjustable by design, allowing the pieces in the Riviera collection to transform in both expression and functionality and can easily be supplemented by a comfortable cushion.



Adjustable



SUNBED

Design: Povl B. Eskildsen
Material: Teak (FSC™ 100%)

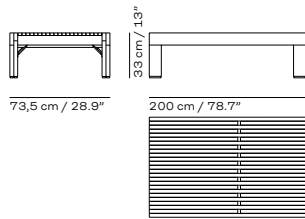

SUNBED CUSHION

Design: Povl B. Eskildsen
Material: Outdoor textile / Quickdry outdoor foam

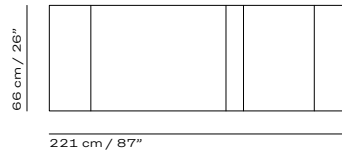

Adjustable



LOUNGE

Design: Povl B. Eskildsen
Material: Teak (FSC™ 100%)

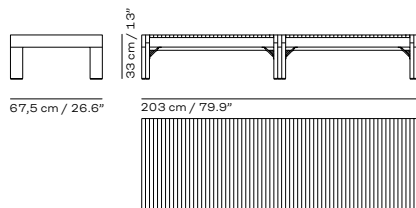

LOUNGE CUSHION

Design: Povl B. Eskildsen
Material: Outdoor textile / Quickdry outdoor foam

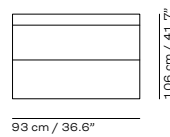

SELANDIA

Selandia series is known for its signature slight curves and elegant Nordic look with subtle French references that hint at long summer nights in the open air.



Foldable



Foldable

ARMCHAIR

Design: Anders & Lars Hegelund
Material: Teak (FSC™ 100%)

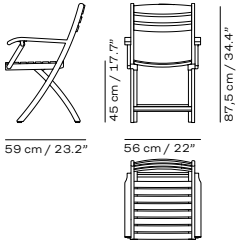

ARMCHAIR CUSHION

Design: Skagerak Design
Material: Outdoor textile / Quickdry outdoor foam

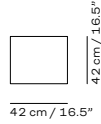

2-SEATER

Design: Anders & Lars Hegelund
Material: Teak (FSC™ 100%)

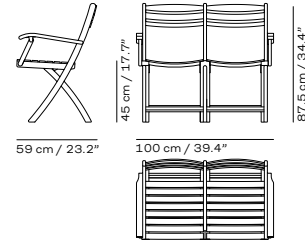

Foldable



CHAIR

Design: Anders & Lars Hegelund
Material: Teak (FSC™ 100%)

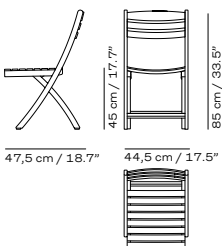

CHAIR CUSHION

Design: Skagerak Design
Material: Outdoor textile / Quickdry outdoor foam

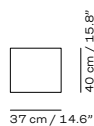



Foldable



Foldable

TABLE Ø94

Design: Anders & Lars Hegelund
Material: Teak (FSC™ 100%)

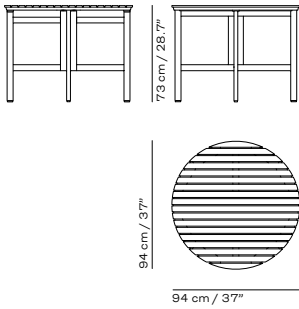

TABLE 75

Design: Skagerak Design
Material: Outdoor textile / Quickdry outdoor foam

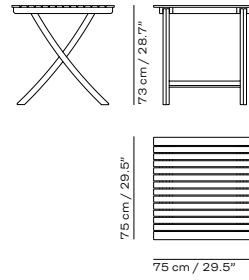
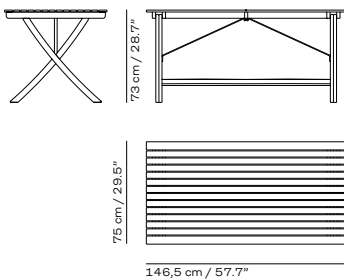

TABLE 147

Design: Skagerak Design
Material: Teak (FSC™ 100%)



TABLE

Design: Mogens Holmriis
Material: Teak (FSC™ 100%)

Add-on:
Extension plate
(2 pcs.)

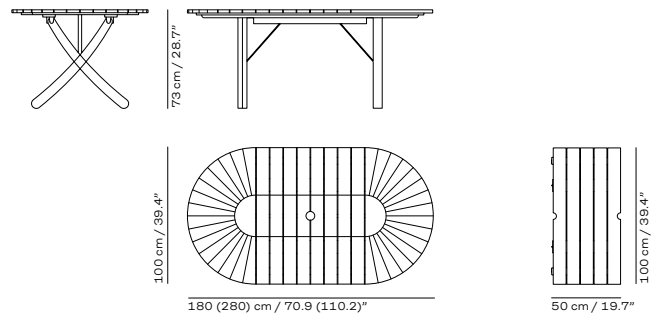

SKAGEN

Named after the northernmost tip of Denmark, the Skagen series of outdoor furniture draws inspiration from the region's natural beauty. Characterised by meticulous craftsmanship and elegant silhouettes, the series is shaped in teak, a durable hard wood that patinates to a silver-grey hue over time.



CHAIR

Design: Mogens Holmriis
Material: Teak (FSC™ 100%)

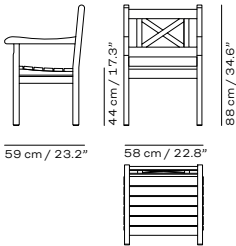

CHAIR CUSHION

Design: Skagerak Design
Material: Outdoor textile / Quickdry outdoor foam

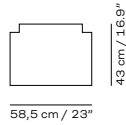

BENCH

Design: Mogens Holmriis
Material: Teak (FSC™ 100%)

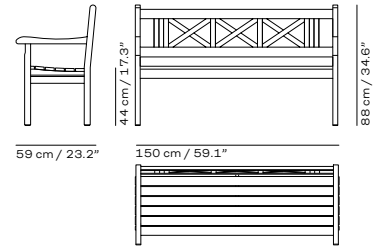

BENCH CUSHION

Design: Skagerak Design
Material: Outdoor textile / Quickdry outdoor foam

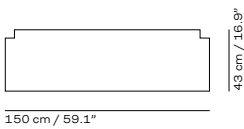

TABLE

Design: Mogens Holmriis
Material: Teak (FSC™ 100%)

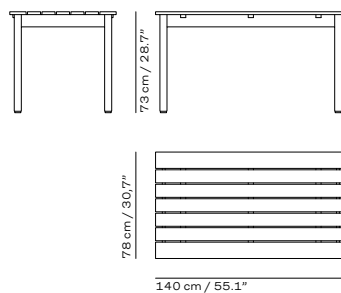



SPIDER WEB

The Spider Web Drying Rack not only resembles the artistry of the tiny predator, it also shares its resilience and ability to stay captivating and functional in even the harshest surroundings. Crafted from durable teak wood and string for outdoor use. The wood patinates to a beautiful silver-grey over time.



DRYING RACK

Design: Anders Brøgger

Material: Teak (FSC™ 100%)

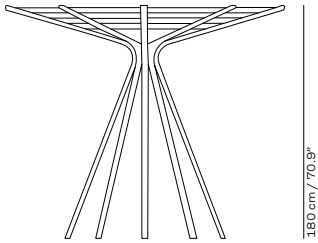

220 cm / 86.6"

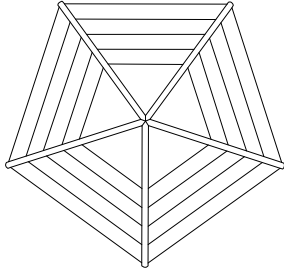

STEAMER

The flowing lines of the Steamer Deck Chair are inspired by the curved lines of a cruise ship. The chair has an integrated footrest that folds up easily when not in use. Steamer Deck Chair is crafted from high-quality teak in a clean and light expression with functionality and comfort at the forefront of this Nordic archetype.



Adjustable



DECK CHAIR

Design: Skagerak Design
Material: Teak (FSC™ 100%)

DECK CHAIR CUSHION

Design: Skagerak Design
Material: Outdoor textile / Quickdry outdoor foam

Model:
Barriere

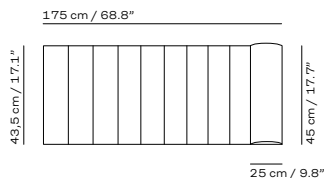
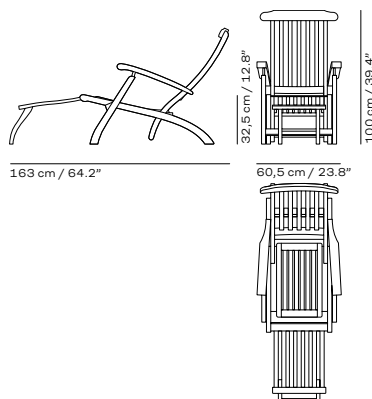

TRADITION

The Tradition lounge series brings a refined sophistication to outdoor spaces and the versatility to adapt to any individual needs. Tradition elevates the outdoor lounging experience to new heights in comfort and beauty. Tradition is a modular series open to multiple configurations.



LOUNGE CHAIR

Design: Povl B. Eskildsen
Material: Teak (FSC™ 100%) / Outdoor textile / Quickdry outdoor foam / Fibre Filling

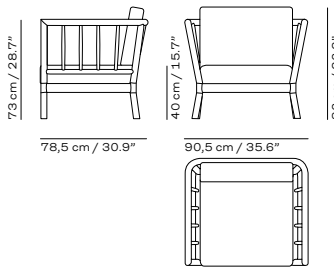

CORNER MODULE

Design: Povl B. Eskildsen
Material: Teak (FSC™ 100%) / Outdoor textile / Quickdry outdoor foam / Fibre Filling

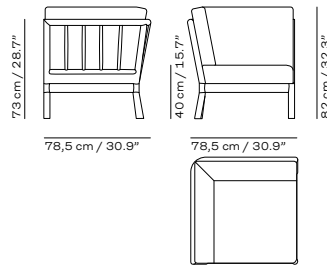

END MODULE

Design: Povl B. Eskildsen
Material: Teak (FSC™ 100%) / Outdoor textile / Quickdry outdoor foam / Fibre Filling

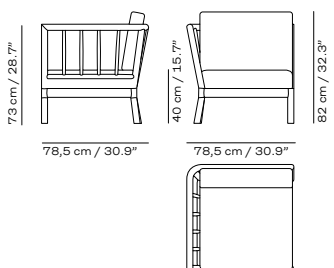

SPACER MODULE

Design: Povl B. Eskildsen
Material: Teak (FSC™ 100%) / Outdoor textile / Quickdry outdoor foam / Fibre Filling

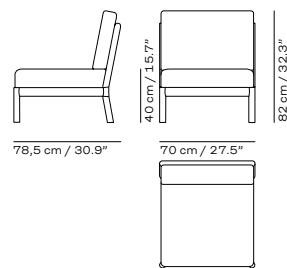



POUF

Design: Povl B. Eskildsen

Material: Teak (FSC™ 100%) / Outdoor textile / Quickdry outdoor foam

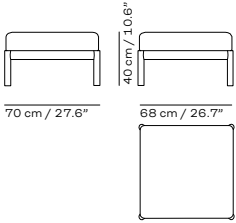

LOUNGE TABLE, H27

Design: Povl B. Eskildsen

Material: Teak (FSC™ 100%)

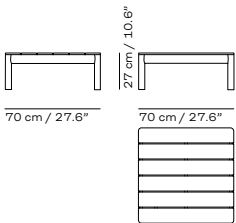

LOUNGE TABLE, H40

Design: Povl B. Eskildsen

Material: Teak (FSC™ 100%)

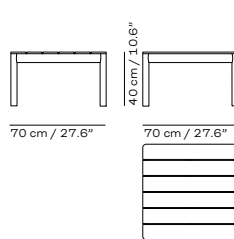



VENDIA

Made with smaller spaces in mind, the Vendia Series delivers all the elegance of traditional garden furniture in a scaled-down design that is ideal for balconies, patios and terraces where space is at a premium. With its small footprint, the chair and table are the ideal choice when space is at a premium.



Foldable

CHAIR

Design: Mogens Holmriis
Material: Teak (FSC™ 100%)

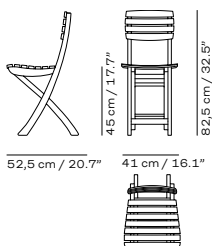

TABLE

Design: Mogens Holmriis
Material: Teak (FSC™ 100%)

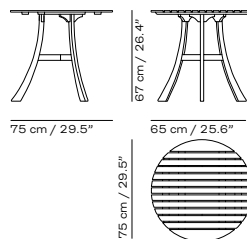

VIRKELYST

Virkelyst is a modern outdoor series characterised by clean lines, discreet details and high comfort. The clean lines of Virkelyst's teak frame strike a satisfying contrast with the thick, soft and comfortable cushions. Perfect for enjoying comfortable hours in sunny gardens or terraces.



POUF

Design: SAYS WHO
Material: Teak (FSC™ 100%) / Outdoor textile / Quickdry outdoor foam

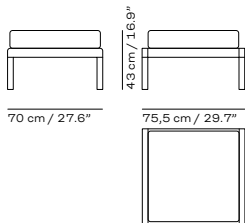

CHAIR

Design: SAYS WHO
Material: Teak (FSC™ 100%) / Outdoor textile / Quickdry outdoor foam

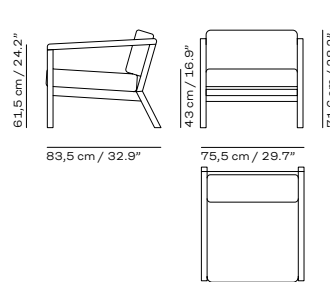

2-SEATER

Design: SAYS WHO
Material: Teak (FSC™ 100%) / Outdoor textile / Quickdry outdoor foam

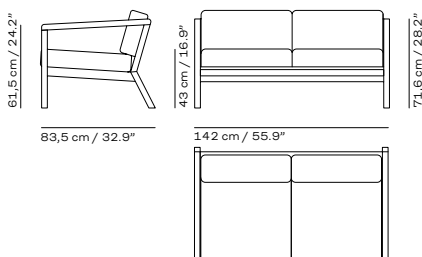

3-SEATER

Design: SAYS WHO
Material: Teak (FSC™ 100%) / Outdoor textile / Quickdry outdoor foam

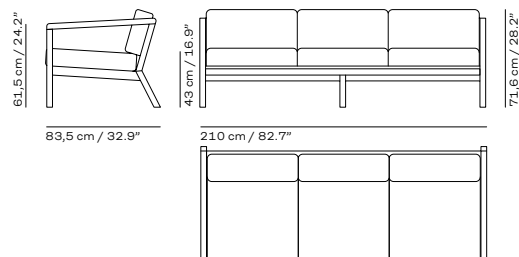
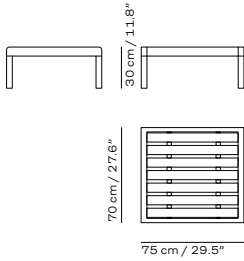



TABLE SMALL

Design: SAYS WHO
Material: Teak (FSC™ 100%)



TABLE

Design: SAYS WHO
Material: Teak (FSC™ 100%)

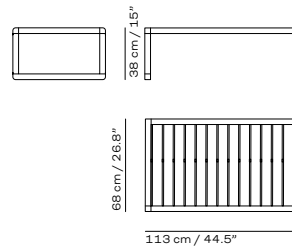
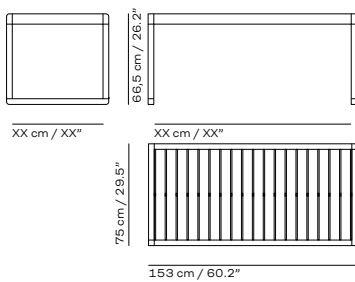

TABLE HIGH

Design: SAYS WHO
Material: Teak (FSC™ 100%)



UMBRELLAS

The umbrellas are beautiful to behold, highly functional, and skilfully crafted from long-lasting materials. The umbrellas are made from water and stain resistant textile with maximum sun protective rating (UPF50+), while the parasol poles are made from durable wood which is able to withstand wind and weather.



ATLANTIS
Design: Skagerak Design
Material: Textile / Kapur
(FSC™ 100%)

Ø×H: 330×275 cm
Pole Ø: 4,8 cm
Recommended foot: 50 kg



ATLANTIS
Design: Skagerak Design
Material: Textile / Kapur
(FSC™ 100%)

W×H: 330×277 cm
Pole Ø: 4,8 cm
Recommended foot: 50 kg



CATANIA
Design: Skagerak Design
Material: Textile / Kapur
(FSC™ 100%)

Ø×H: 270×250 cm
Pole Ø: 3,8 cm
Recommended foot: 30 kg



MESSINA
Design: Skagerak Design
Material: Textile / Kapur
(FSC™ 100%)

Ø×H: 210×220 cm
Pole Ø: 3,8 cm
Recommended foot: 30 kg



MESSINA
Design: Skagerak Design
Material: Textile / Kapur
(FSC™ 100%)

Ø×H: 270×250 cm
Pole Ø: 3,8 cm
Recommended foot: 30 kg



MESSINA
Design: Skagerak Design
Material: Textile / Kapur
(FSC™ 100%)

Ø×H: 300×240 cm
Pole Ø: 4,8 cm
Recommended foot: 50 kg



MESSINA
Design: Skagerak Design
Material: Textile / Kapur
(FSC™ 100%)

W×H: 270×250 cm
Pole Ø: 3,8 cm
Recommended foot: 30 kg



MESSINA
Design: Skagerak Design
Material: Textile / Kapur
(FSC™ 100%)

W×H: 300×270 cm
Pole Ø: 4,8 cm
Recommended foot: 50 kg

UMBRELLAS

Capri umbrella foot is a functional and long-lasting piece for umbrellas made of steel and concrete. The natural and robust materials will stand firm year after year, while the design allows rain to drain off easily. The smart protective cover for the umbrellas is good for storing safely, especially during the winter.



CAPRI 30 KG
Design: Skagerak Design
Material: Concrete /
Stainless Steel

Ø×H: 50×43 cm
Pole max Ø: 4 cm

CAPRI 50 KG
Design: Skagerak Design
Material: Concrete /
Stainless Steel

Ø×H: 60×45 cm
Pole max Ø: 5 cm

COVER
Design: Skagerak Design
Material: Plastic

Ø×H: 48×250 cm
Compatible for umbrella:
270, 300, 330

COVER
Design: Skagerak Design
Material: Plastic

Ø×H: 47×184 cm
Compatible for umbrella:
Ø210, Ø270, Ø300, Ø330

OTHER



HELIOS (FIREBOWL)
Design: Skagerak Design
Material: Cast Iron

Ø×H: 58×19 cm

CARE KIT
Wood Cleaner
by Auro

0,5 liter

CURA (OIL)
Treatment for
wood products

0,5 liter

NICE TO KNOW

HEADQUARTERS

FRITZ HANSEN
Allerødvej 8
3450 Allerød
Denmark
Tel: +45 48 17 23 00

GET IN TOUCH

SALES - ASIA & OCEANIA
customerserviceasia@fritzhansen.com
Tel: +81 3 3400 3316

SALES - EUROPE
salesupport@fritzhansen.com
Tel: +45 70 80 70 90

SALES - NORTH AMERICA
info@fritzhansen.com
Tel: 212 219 3226

PRESS - GLOBAL
press@fritzhansen.com
[learn more](#)

NEWSLETTER

Sign up at:
fritzhansen.com/sign-up

DOWNLOADS

Find 2D & 3D files, imagery,
product facts and much more
at: downloads.fritzhansen.com

FOLLOW US

INSTAGRAM
[@fritzhansen](https://www.instagram.com/fritzhansen)

PINTEREST
[@fritzhansen](https://www.pinterest.com/fritzhansen)

FACEBOOK
Fritz Hansen

LINKEDIN
Fritz Hansen

FRITZHANSEN.COM



Textile: Light Sand

F.H.1872