

viccarbe

Master Catalogue

Mediterranean Collaboration



MEDITERRANEAN COLLABORATION

It seems clear that the borders between spaces are almost non-existent, offices look like hotels, hotels look like houses, houses... The habitat has become an umbrella that gathers more and more similar spaces looking for comfort, singularity and recognition, but what makes a project really unique?

At a time such as the present, surrounded by ephemeral fashions, I would like to explain how we, in Viccarbe, understand the concept of Mediterranean collaboration. Viccarbe is a company born in Valencia, a Mediterranean city where we have lived for centuries with cultures as diverse as the Roman, Visigoth and Muslim. This cultural mix makes our genes a cocktail so diverse that we are designed in a natural way for collaboration and adaptation away from limitations and flags.

All of this is part of our soul, added to more than 300 days of sunshine a year and a diet that positions us as one of the most long-lived countries in the world. I believe that somehow, being so

optimistic and timeless is reflected in the way we design and showcase our collection. We are driven by a passion for listening, seeking what unites us rather than what sets us apart, always with the person as the focus and fundamental axis of each new project.

In an increasingly digital world, we consider that humanism will be more core than ever and, in this matter, we have many years—I dare say even centuries—of advantage.

Nature loves simplicity and unity, this is why we put so much effort into it, and that is why it is so important for us to create friendly and iconic products, that naturally provoke new and unexpected relationships between users, because good design shouldn't have to be explained.

The natural cross between people and attraction between users, spontaneously promoted by our products, generates collaborative connections that provoke innovative ideas and unexpected solutions.

VICTOR CARRASCO BERLANGA

Founder, VICCARBE

Index

MEDITERRANEAN COLLABORATION
1

DESIGNED IN THE SUN
4

VICCARBE.COM
6

DESIGNERS
8

THE COLLECTION
10

SAVINA SOFA
12

CAMBIO TABLE
52

CAMBIO LOW TABLE
76

ALETA CHAIR
88

ALETA STOOL
112

ALETA LOUNGE CHAIR
122

BURIN TABLE
130

SOLAR TABLE
144

COMMON BENCH
164

COMMON LOW TABLE
162

TRESTLE TABLE
174

TRESTLE BENCH
198

SISTEMA COLLECTION
208

EARS CHAIR
252

EARS STOOL
258

VICCARBE KITCHEN
262

COPA CHAIR
264

COPA STOOL
272

COPA LOUNGE CHAIR
276

MAARTEN PLASTIC CHAIR
284

MAARTEN PLASTIC STOOL
312

MAARTEN CHAIR
316

MAARTEN STOOL
330

MAARTEN LOUNGE CHAIR
332

FUNDA CHAIR
338

FUNDA LOUNGE CHAIR
346

FUNDA STOOL
348

KLIP CHAIR
356

KLIP STOOL
372

QUADRA CHAIR
376

ACE LOUNGE CHAIR
396

PENTA ARMCHAIR
406

LEVITT COLLECTION
416

SEASON CHAIR
430

SEASON SOFA
440

SEASON BENCH
452

SEASON POUF
460

STEP SOFA
468

NAGI ARMCHAIR
484

LAST MINUTE STOOL
494

STANDARD TABLES
500

BRIX ARMCHAIR
506

TORII BENCH
512

COLUBI ARMCHAIR
520

FEDELE ARMCHAIR
532

WRAPP ARMCHAIR
538

LOW TABLES
542

ACCESSORIES
576

QUICK EXPEDITION
582

COMING SOON
584

LATEST PROJECTS
592

OUR CLIENTS
597

MORE INFO
598

FABRICS & SAMPLES
604

VICCARBE 3D AWARDS
606

Designed in the Sun

"Our soul belongs to the Mediterranean."

Our soul belongs to the Mediterranean. Here, light has an impressive influence on who we are, how we live and how we feel. Our warm character, our relaxed vibe, and the way we take care of what really matters reflects our deep connection with the sun. We are creativity, energy, and spontaneity.

In the Mediterranean, design lives free of all pretense, combining warmth, simplicity, and convenience. Everything has a purpose, there is no room for unnecessary excess and only the truly important remains.

Natural light exerts a powerful influence in our sketches. This glow is what brings everything to life and unleashes our artistic soul. It is part of our identity and it is the starting point of our designs, reflected through our passion for colors, the warmth we convey, our attention to detail and in the way we appreciate the small things.

We enjoy being surrounded by people, we like to share, communicate, and learn from the talented ones we admire. Collaborative work has always been part of our culture. Meaningful collaboration can improve communication and make everyone feel part of a whole. We are firm defenders of collaborative spaces where imagination releases to create perfect synergies.

Our collection is an essential selection of Mediterranean pieces for spaces where collaboration and dialog flow. This is the consequence of our "Designed in the Sun".



On the right, a picture of Viccarbe Fábrica

viccarbe.com

2D · 3D · BIM · Revit · Techinal Sheets · Quality
Tests · Samples · pCon

We want to welcome you to the place where everything happens, where we invite you to enjoy reading and to take in huge doses of inspiration. Make www.viccarbe.com your comfort zone, like a workplace with greater flexibility and freedom of movement. Make yourself comfortable and keep your curiosity. Enjoy the journey.

Design is our journey

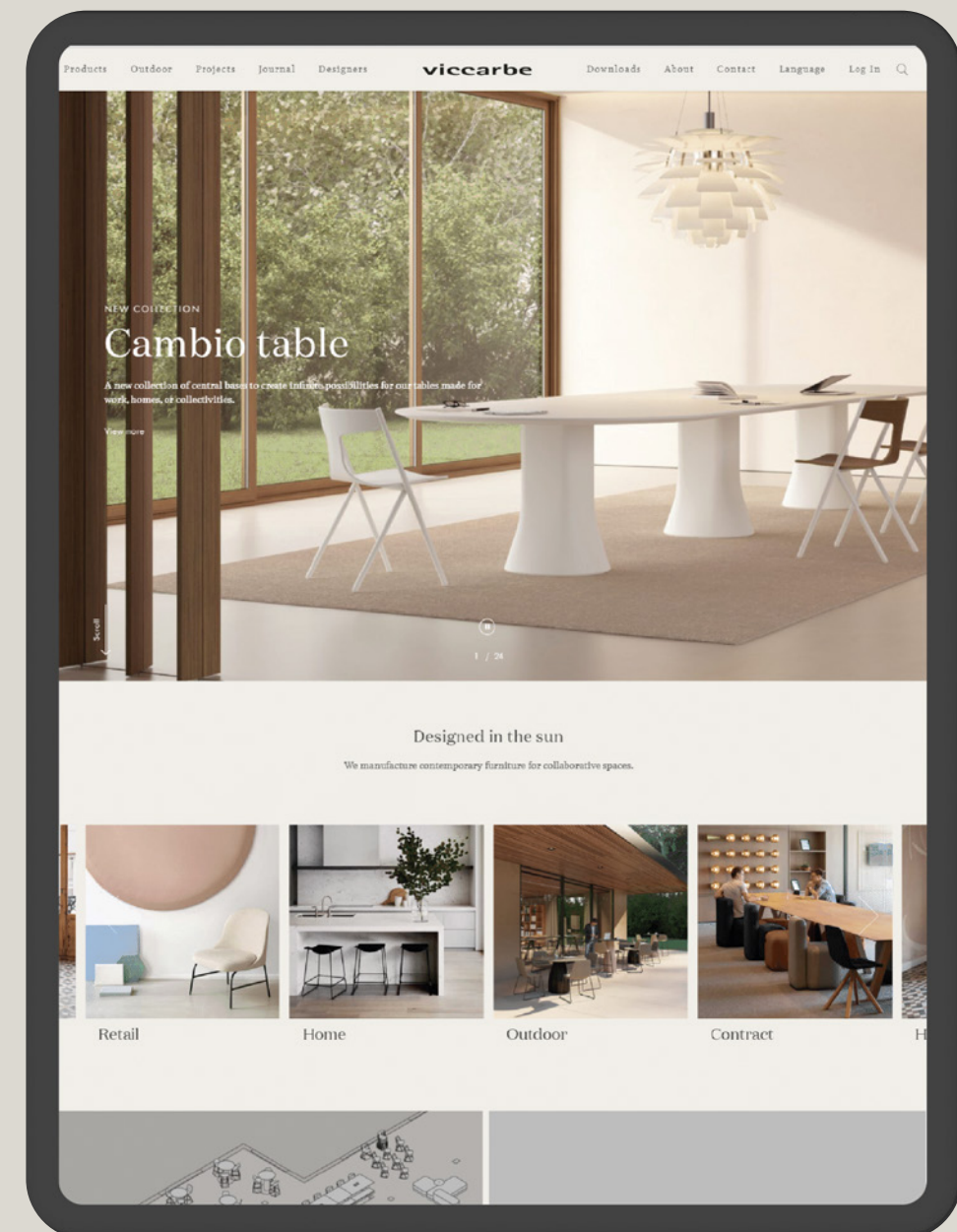

Our designers



ELISA OSSINO



JAIME HAYON



JEAN-MARIE MASSAUD



JOHN PAWSON



RAMOS&BASSOLS



JORGE PENSI



KENSAKU OSHIRO



LIEVORE ALTHERR MOLINA



L + R PALOMBA



MARIO FERRARINI



MARC KRUSIN



NAOTO FUKASAWA

Talent across the globe



PATRICIA URQUIOLA



PEDRO PAULO-VENZON



PIERO LISSONI



RAMÓN ÚBEDA Y OTTO CANALDA



STEFAN DIEZ



TOAN NGUYEN



TOMOYA TABUCHI



VÍCTOR CARRASCO



VINCENT VAN DUYSEN



JASPER MORRISON

We cannot predict the future but we can design our own with the help of the most talented ones. We strive to improve everyday by learning from the best, we are always evolving and constantly seeking ways of getting better. We are honoured that the world's top designers wish to interpret our Mediterranean lifestyle, regardless of their country of origin, to conceive sensational pieces to brighten our lives.

The Collection



Ears Chair - Pg. 252



Quadra Chair - Pg. 376



Copa Chair - Pg. 264



Funda Chair - Pg. 338



Maarten Plastic Chair - Pg. 284



Maarten Chair - Pg. 316



Aleta Chair - Pg. 88



Klip Chair - Pg. 150



Season Chair - Pg. 430



Maarten Plastic Stool - Pg. 312



Maarten Stool - Pg. 332



Maarten Plastic Stool - Pg. 312



Maarten Stool - Pg. 330



Aleta Stool - Pg. 112



Klip Stool - Pg. 372



Copa Stool - Pg. 272



Copa Stool - Pg. 272



Copa Stool - Pg. 272



Ears Stool - Pg. 258



Funda Stool - Pg. 348



Last Minute Stool - Pg. 494



Copa Lounge Chair - Pg. 276



Aleta Lounge Chair - Pg. 122



Maarten Lounge Chair - Pg. 332



Ace Armchair - Pg. 396



Colubi Armchair - Pg. 520



Brix Armchair - Pg. 506



Nagi Armchair - Pg. 484



Penta Armchair - Pg. 406



Wrapp Armchair - Pg. 538



Savina Armchair - Pg. 146



Funda Lounge Chair - Pg. 340



Sistema Armchair - Pg. 246



Sistema Armchair - Pg. 246



Sistema Armchair - Pg. 266



Sistema Armchair - Pg. 246



Sistema Armchair - Pg. 244



Sistema Armchair - Pg. 244



Step Armchair - Pg. 483



Fedele Armchair - Pg. 532



Levitt Armchair - Pg. 416



New addition, Funda Collection - Pg. 590



Sistema Legs Sofa - Pg. 208



Sistema Floor Sofa - Pg. 238



Levitt Sofa - Pg. 416



Step Sofa - Pg. 468



Season Sofa - Pg. 440



Savina Sofa - Pg. 12



Trestle Bench - Pg. 198



Common Bench - Pg. 162



Sistema Bench - Pg. 246



Season Bench - Pg. 452



Toril Bench - Pg. 512



Season Pouf - Pg. 458



Trestle Table - Pg. 174



Solar Table - Pg. 144



Eli Table - Pg. 500



Stan Table - Pg. 500



Maarten Table - Pg. 324



Burin Table - Pg. 130



Cambio Table - Pg. 52



New table (Jasper Morrison) - Pg. 586



New table (John Pawson) - Pg. 588



Cambio Low Table - Pg. 76



Eli Low Table - Pg. 574



Aleta Low Table - Pg. 556



Ryutaro Low Table - Pg. 550



Shape Low Table - Pg. 554



Tiers Low Table - Pg. 560



Window - Pg. 578



Stan Low Table - Pg. 570



Bamba Low Table - Pg. 662



Holy Day Low Table - Pg. 566



Serra Low Table - Pg. 564



Common Low Table - Pg. 572



Maarten Low Table - Pg. 552



Burin Mini Low Table - Pg. 546



Trino Low Table - Pg. 548



Giro Low Table - Pg. 558



Keel Shelves - Pg. 580



Up in the Air, Low Table - Pg. 568

SAVINA

Island of collaboration

A sofa designed by Victor Carrasco, 2022

2022 — Savina joins our collection of ancillary furniture to enhance soft collaboration. An innovative sofa that presents a new universe of comfortable working solutions for every office, workplace, home, hospitality area or hybrid space.

Due to its soothing silhouette and its infinite compositions, we like to call it an island of collaboration, a reassuring spot to gather, work and retreat. An original, flexible and mindful sitting concept for hybrid spaces to nurture synergy, creativity, productivity, and well-being.

Get immersed and transport yourself into the era of soft collaborative comfort with Savina. This is Savina.



Savina takes its name from the natural entrance to the island of Formentera

Savina takes its name from the natural entrance to the island of Formentera in Spain. This island is possibly one of the most serene places in the Mediterranean that connects you with nature and makes you unwind. This pleasant feeling of relaxation is what we wanted to recreate when sitting on a Savina sofa.



Featuring Savina with chaise longue, matching cushions and upholstered arm





Featuring Savina sofa with different modules, auxiliary tables and matching cushions



Infinite modularity with ease of movement, agility and comfort



With hidden casters.
Pure dynamism.



Savina



ECOALF
EDITION



Ecoalf is a pioneer international sustainable fashion brand and is now our exclusive partner. Together, we lead the way to a more sustainable interior design industry



On the left, Victor Carrasco founder of Viccarbe. On the right, Javier Goyeneche founder of Ecoalf. Both sitting on Maarten chairs upholstered in recycled fabrics by Ecoalf

As a novelty, Savina is also available with fabrics from recycled materials by Ecoalf, the pioneer brand in sustainable fashion. This joint venture materialized with a first edition of our iconic Maarten chairs, upholstered with their recycled fabrics made with residues collected from oceans around the world. As drivers of innovation within the fashion and design sectors, together with Ecoalf we blend our know-how in order to lead the journey to sustainability within the furniture and design industry. The aim of our collaboration is to highlight the responsibility of every manufacturer and agent involved in the furniture industry, and to achieve a positive outcome for the environment.

With Savina, Ecoalf edition, we have now gone a step further. We wanted to design a sofa to last many years, upholstered with Ecoalf's ethically recycled materials, and ingeniously made with wood from controlled timber, recycled and recyclable steel springs, and a percentage of soft padding from recycled mattresses collected by Recipur. Together, we lead the change to raise awareness in the design industry. *Because there is no Planet B.*

"A pioneer joint venture in the pursuit of maximum sustainability in the design industry."



In the EU, over 10.7 million tonnes of furniture waste are generated annually with 80-90% being incinerated or sent to landfill



**1. PROBLEM:
DISCARDED FURNITURE**

In Spain alone, over 1.5 million mattresses end up in landfills each year.



**2. SOLUTION:
RECIPUR COLLECTS THEM**

They use an innovative process to recycle the mattresses and give them a second life.



**3. ECOPURE® TECH:
70% RECYCLED FOAM**

With years of scientific studies, the foam provides the sofa maximum comfort.



**4. OUR COLLABORATION:
THE SAVINA SOFA**

The three companies come together to offer a cutting-edge sofa that promotes the circular economy.

R&D IN RECYCLED MATERIALS

ECOPURE®'s recycled foam technology recycles post-consumer mattresses and perfectly cushions the piece, it is upholstered with Ecoalf's recycled fabric to save water, reduce CO2 emissions and avoid using new resources.

ECO-DESIGN & CIRCULARITY

Designed with the end in mind, using the least number of parts and a minimal form so that the 7 pieces of the modular sofa can easily be deconstructed and the parts recycled into new pieces.

ECO-DESIGN & CIRCULARITY

Designed with the end in mind, using the least number of parts and a minimal form so that the 7 pieces of the modular sofa can easily be deconstructed and the parts recycled into new pieces.

TRACEABILITY & PROXIMITY

100% Made in Spain, every single step from the design to the production takes place within a 100km mile range of Viccarbe's HQ.

A TIMELESS SOFA WITH ECOALF FASHION RECYCLED FABRICS

Five timeless colors, aligned with Ecoalf's coveted fashion collection, are available for Savina's upholstery. Soft and pleasant recycled fabrics by Ecoalf, made from over 250 million plastic bottles collected in oceans. These residues are first transformed into flakes and pellets in order to obtain a high-quality, 100% recycled filament to create long-lasting top-quality garments and upholstery fabrics for our Maarten and Savina lines. Choose your favorite color combination to create a sofa designed to last.

Visit Ecoalf.com for more info

COLORS



White sand



Dusty Olive



Topo



Caviar



Petrol



Savina Chaise

"The independent chaise invites you to work for hours, exchanging ideas, working solo or in teams."



A versatile chaise with casters to focus whilst performing the daily tasks. Designed to last



Featuring Savina Chaise with wooden table and technical fabric for extra resistance, designed to last



CONNECTIVITY & MOBILITY

Connectivity is sorted thanks to its useful electrification options and its hidden casters add freedom of movement.

SAVINA & WORK

Working on a chaise longue has multiple benefits for the mind and soul. A practical and comfortable addition to places that seek a special seat for visitors, and workers to perform, relax and unwind. A piece that makes a great use of the space available and conveys a welcoming spot when looking for inspiration.

MULTIPLE OPTIONS TO CHOOSE FROM

Savina Chaise has multiple options: includes hidden casters, making it easy to place it anywhere and to create infinite combinations depending on the situation, accessories such as wooden tables, great when working on the laptop, arranging a videocall or enjoying a quick coffee, and discreet integrated electrifications, solving problems of connectivity when working away from the usual desk.

TECHNICAL FABRIC AT FOOT HEIGHT TO INCREASE DURABILITY

Mix and match different fabrics to achieve a bespoke chaise longue to work all day long. The technical fabric at foot height **brings extra resistance and durability**, adding a modern and relaxed aesthetic to the design. A good option for high-traffic areas: airports, hotel lobbies or staff breakrooms. Made to last.



Featuring Savina sofa with corner module, matching cushions, auxiliary tables, and integrated electrification

The soft silhouette of Savina
is the perfect balance between
visual and physical comfort



Ultimately designed
to encourage users to
engage with others

SAVINA & EDUCATION

Savina brings ultimate comfort to educational centers, enabling students to feel comfortable during reading, studying or leisure time. A sofa created to foster collaboration, ultimately designed to encourage users to engage with others. Perfect to greet visitors and enhance receptions and lounge areas too.





SAVINA & OFFICE

Cleverly designed, Savina is a multi-purpose modular seating system that works in offices and corporate environments, allowing workers to easily rearrange compositions and move it around thanks to its functional hidden casters. An all-rounder that adapts to any workspace scenery effortlessly.

Configure your own Savina sofa

Discover its components

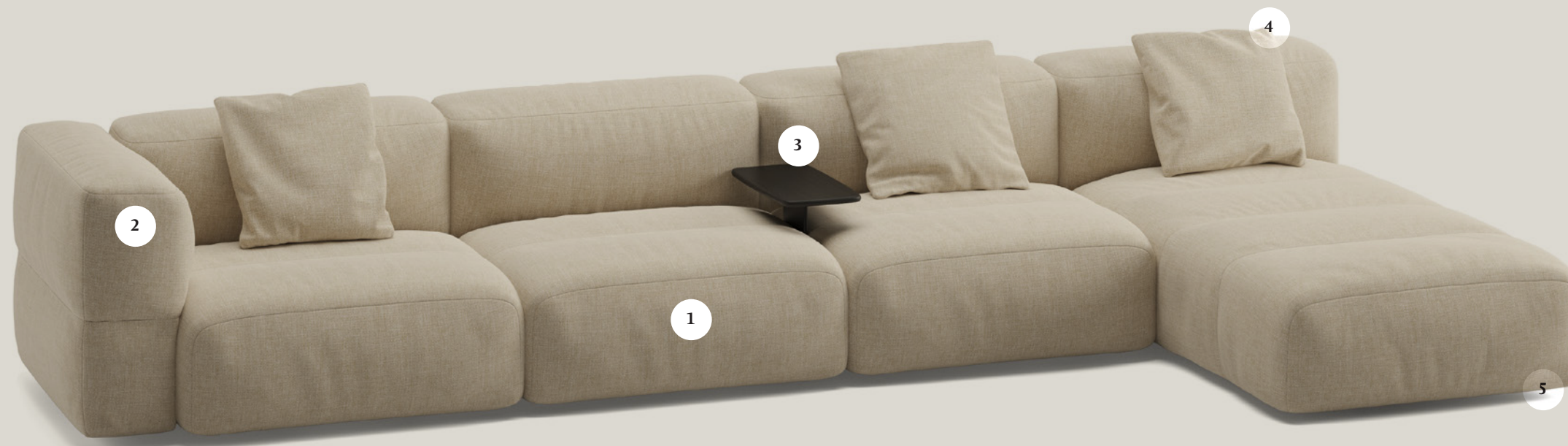

Creating your own Savina sofa is easy, follow these simple steps to find the best match for your space:

1. Choose your favorite modules
2. Choose the upholstery from our graded-in collections (Fabric, leather, eco-leather, recycled by Ecoalf)
3. If required, choose the finish for the arms
4. Accessories: tables, cushions, electrifications...
5. Add hidden casters for unlimited versatility and freedom.

1 Modules

- A. Backless module
- B. Backrest module
- C. End module
- D. Corner module
- E. Chaise

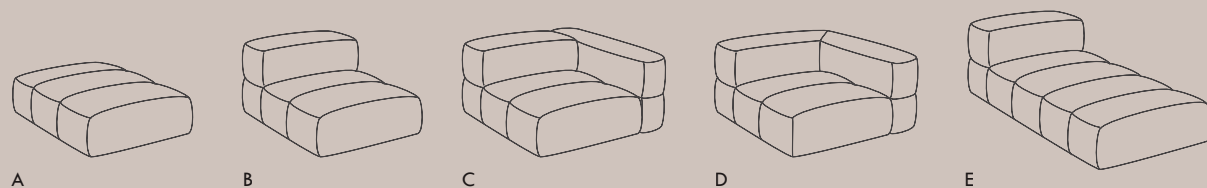

2 Arms

- F. Upholstered arm
- G. End upholstered arm

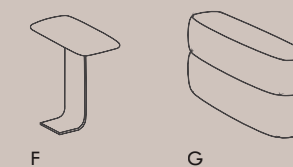

3 Accessories

- H. Table
- I. Cushions

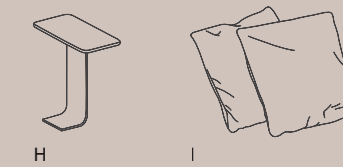

4 Fixed component

- J. Hidden casters

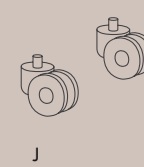



Featuring Savina sofa with different modules, upholstered auxiliary tables, integrated electrifications and matching cushions

SAVINA ARMCHAIR

Savina joins our ancillary furniture collection as a modular collaborative island. The armchair leads to more sustainable working and lounging solutions for homes and offices. A comfortable design which is ideal to create a cozy reading corner in the living room or an inviting welcome area in the office. As a plus, Savina fosters circular economy thanks to its innovative production process, enabling to recycle all its parts independently whenever required.



DESIGNED FOR SUSTAINABILITY

"We have created a recyclable sofa, made with as many components as possible from recycled materials. A living project that will be updated as we continue to strive in recycling innovation."



For us there is nothing more sustainable than creating pieces that will last a lifetime. Pieces that will be part of our journey and will be present in our everyday. Everything we make must be meaningful for the environment and for our lives.

With the clear purpose of leading the way into a more sustainable design industry, with Savina we wanted to go a step further. We pursued a recyclable sofa, made with as many components as possible from recycled materials. A living project that will be updated and renewed as we continue to strive in recycling innovation. We also desired a sofa that was pure comfort, both visually and physically, and invited users to sit on

it for hours, collaborating, sharing thoughts, or just relaxing. Our "design for sustainability" ethos focuses on implementing changes in our collections, that prioritize the environment and foster conscious consumption habits. We have attained a recycled sofa that respects the user's requirements of space, use and function. A flexible sofa that works in any type of environment and contributes to a more respectful design industry. Therefore, we stand to innovate and bring conscious practices into our sector that will lead the change in how we perceive design. We create designs to last.

Illustration showcasing the different components that shape Savina.

Fabrics

Choose your favorite upholstery from our collection, including the recycled fabric line by Ecoalf.

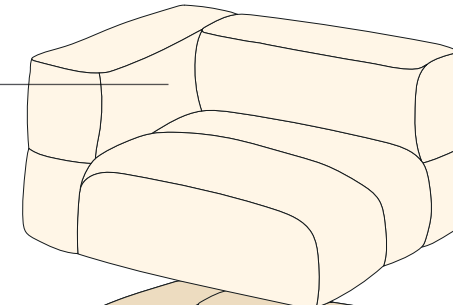

Feathers

RDS certified down fill.

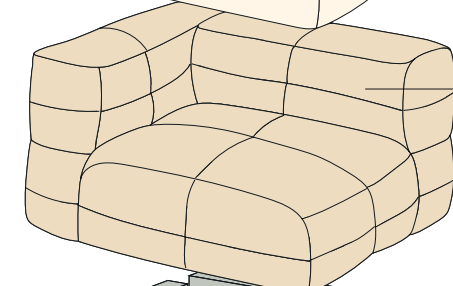

Recyclable foam

Recyclable, non-deformable expanded polyurethane foam of different densities by Recipur.

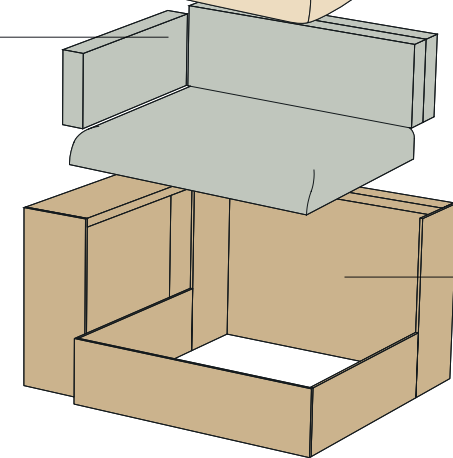

Recycled foam

Medium density recycled polyurethane foam.

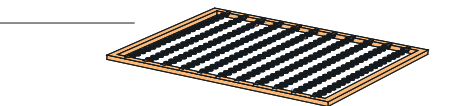

Springs

Frame and springs made of high-strength and flexible steel made with recycled materials.

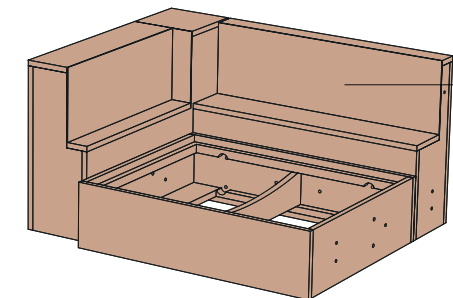

Frame

Solid wood structure from controlled timber with PEFC and FSC certifications.

Casters

Freedom of movement thanks to its discreet hidden casters.

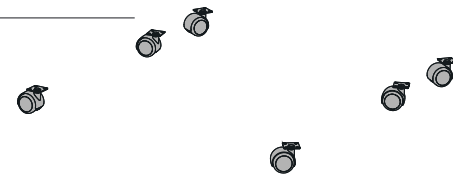

Mix and match all the options available for Savina. You can unleash your imagination to design your bespoke sofa from zero, to best fulfil your requirements or, if you prefer, you can get inspired by a series of pre-defined compositions that will help you bring this collaborative island to life into your projects.

Either way, the final result will be a comfortable sofa that fosters interaction, well-being and productivity, all in one. A singular collaborative piece that is able to add a contemporary twist to homes, workplaces, hotels and high-traffic environments all around the world.

Savina sofa



Savina sofa, Composition 1



Savina sofa, Composition 2



Savina sofa, Composition 3



Savina sofa, Composition 4



Savina sofa, Composition 5



Savina sofa, Composition 6



Savina sofa, Composition 7



Savina sofa, Composition 8



Savina sofa, Composition 9



Savina sofa, Composition 10



Savina sofa, Composition 11



Connectivity



1. Seat socket
2. Power socket, upholstered
3. Powerbox under table

CAMBIO

A minimalist approach

A collection of tables designed by Victor Carrasco, 2022

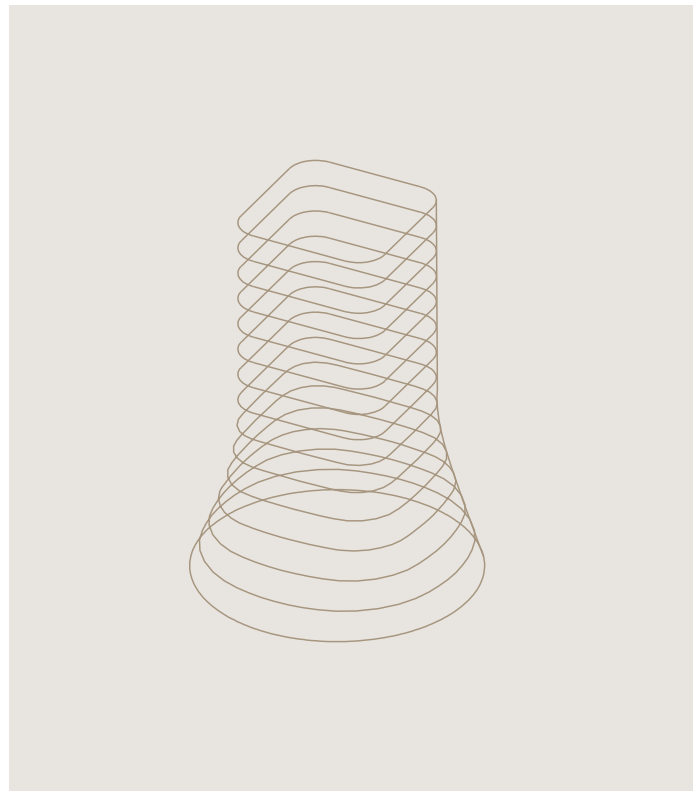

“As the Greek philosopher Heraclitus said, “the only constant in life is change”. The best relationships as well as the finest designs evolve only in a very natural manner. My wish was simple, I allured to transit from a square to a round surface with kindness. This is how Cambio is born. A new collection of central bases to create infinite possibilities for our tables made

for work, homes, or collectivities. An exercise of subtleties to outline a timeless design, timeless and silent as well as iconic thanks to its elegant morphology and its profound message to promote sensible and sustainable changes.”

By Victor Carrasco.



“An exercise of subtleties to outline a timeless design, an elegant game of geometry which promotes sustainable and sensible change phases.”

Featuring Cambio table in H74 | 29,13" Ø70cm | Ø27,55" with black base and black tabletop. Chair is Funda in black by Stefan Diez



Featuring Cambio table in H74 | 29,13" 500x150cm |
196,85"x59,05" with three white bases and white tabletop,
styled with Quadra chairs by Mario Ferrarini

Choose your size,
every dimension is covered

Every dimension is taken into consideration to fulfil every spatial requirement with the Cambio table. A single base can hold round tabletops of up to two meters, acting as a great dining or meeting table for offices, restaurants, hotels and homes. When upgrading to double or triple bases, the possibilities are endless as it takes tabletops of up to 500x150cm. With Cambio, you can always find space for someone else.

H74, triple

*Ready for dimensions up to
500x150 cm | 196,85"x59,05"*



H74, double

*Ready for dimensions up to
300x150 cm | 118,11"x59,05"*

Featuring Cambio tables in diverse sizes, bases and tabletops. From left to right:
H74cm | 17,71" and two bases with 300x150cm | 118,11x59,05" tabletop, H74cm |
29,13" and three bases with 500x150cm | 196,85"x59,05" tabletop, H45 | 29,13" and
marble tabletop, H74 | 29,13" and wooden tabletop

Beautifully
crafted in wood



MADE FOR WOOD LOVERS

Only timeless materials, which are longlasting and promote sustainable consumption habits such as wood from controlled timber sources are available to assemble each table. Choose wood for an organic aesthetic, the oak tabletop conveys a crafted expression to Cambio and a comforting appeal, creating an authentic gathering point to celebrate, work or dine. A versatile and genuine table made for wood lovers.

Featuring Cambio table H74cm | 29,13" and
Ø150cm | Ø59,05" wooden tabletop. Chairs
are Maarten Plastic



Featuring Cambio table H74cm | 29.13" with double base in black finish, combined with Copa Soft chairs by Ramos & Bassols

Meetings made comfortable with Cambio

The versatility of the Cambio table joins the Viccarbe collection to add innovative working and dining solutions for offices, restaurants, hotels and homes. Its minimalist double base can be easily integrated into meeting, board or conference rooms combined with its oval tabletop, ideal when extra seating is required as there is always room for more.

Featuring Cambio table H74cm | 29,13", with double base in white and oval tabletop in wood. Chairs are Funda by Stefan Diez



DINE OR WORK WITH CAMBIO

The different dimensions and multiple finishes for its tabletop effortlessly integrate Cambio in any working or dining scenario. Great as a bistro table for modern cafés or restaurants, the collection is also a great fit for collaborative or co-working spaces, libraries, and canteens in office, educational or hospitality venues.





A BALANCED TABLE FOR HOMOGENOUS SPACES

Cambio stands in the center of any space, almost like a refined sculpture, silently accomplishing our demands. Its square tabletop makes a great table for quick catch-ups or working solo in the office. Combined with other tabletops of larger dimensions, Cambio offers practical working solutions with a consistent and coherent aesthetic throughout any floor layout.

On the right, featuring Cambio table H74 | 29,13"cm with 70x70cm | 27,55x27,55" tabletop in black finish. Chairs are Maarten with wooden armrests

On the right, Sistema bench as a greeting spot on the front and on the back, Cambio tables combined with Maarten and Season chairs







THE PLACE TO COLLABORATE

For us, a table is so much more than a functional element. It is the heart of the home, the place to gather, celebrate and enjoy. It is the center of the office, the spot to meet, create and innovate. Our mediterranean culture is all about collaborating and sharing, it is the way we connect and bond with others around a table what shapes our lifestyle and forms our character. With its minimalist soul and its geometric lines, Cambio is a great piece to discreetly connect users, fostering collaboration in all its means. Cambio plays its part, leaving space to what truly matters.

Featuring Cambio table H74cm | 29,13" and
Ø150cm | Ø59,05" black tabletop. Chairs are Ears
by Piero Lissoni



Timeless marble

COMING SOON

Over the years we have been striving to innovate in new materials that conferred a unique allure to our mediterranean furniture. Timeless finishes that contribute to make our pieces very longlasting and aesthetically pleasing.

Soon, you will be able to order marble tabletops for our Cambio collection. Marble is a fine stone, one of the most environmentally friendly materials and enduring surfaces to work or dine. Due to its classic expression, it complements any chair, armchair and sofa in our collection, upgrading the overall design experience.



On the right, featuring Cambio table
H74cm | 29,13" Ø150cm | 59,05" tabletop
in white marble



On these pages, featuring Cambio table H74cm | 29,13" Ø150cm | 59,05" tabletop in black marble and Cambio table H45cm | 17,71" Ø120cm | 47,24" tabletop in white marble

Comfort is assured



On these pages, featuring Cambio table H45cm | 17,71"
Ø120cm | Ø47,24", tabletop in matt oak with a powerbox.
Lounge chairs are Copa with wooden legs, by Ramos & Bassols

Cambio low table with integrated connectivity

CONNECTIVITY

As the rest of the tables in our collection, Cambio also has the possibility of including discreet electrification options to keep users connected on the go. Practical connectivity solutions with a seamless design, perfectly integrated in our ancillary furniture.







TABLETOPS

As to the tabletops, these are available in different shapes such as square, oval, or round, allowing big compositions of up to two meters in diameter or five meters in length, without compromising an ounce of durability and resistance. Finishes range from matt oak, laminates in white or black, polished coatings, a wide chromatic variety of lacquers, to compacts for outdoor use, and the latest incorporation: marble in white or black.

The minimalist table is also available for outdoor spaces, bringing new possibilities to lounge or work. A collection of tables offering kind solutions to work, enjoy and appreciate the alfresco space as an extension of the office. Tables crafted with long-lasting materials and timeless finishes to connect spaces and users, achieving a balanced and homogeneous aesthetic both in and out.

Cambio table moves outdoors

On these pages, featuring Cambio table H74cm | 29,13" Ø100cm | 39,37" outdoor version. Chairs are Maarten Plastic.



Cambio table



Cambio H74 D60cm /
H29.13" D23.62"

Cambio H74 D70cm /
H29.13" D27.55"

Cambio H74 D80cm /
H29.13" D31.49"

Cambio H74 D100cm /
H29.13" D39.37"



Cambio H74 90x90 cm /
H29.13" 35.43"x35.43"

Cambio H74 D150cm /
H29.13" D59.05"

Cambio H74 140x140 cm /
H29.13" 55.11"x55.11"

Cambio H74 D200cm /
H29.13" D78.74"



Cambio double base H74 300x150 cm / H29.13" 118.11"x59.05"

Cambio double base H74 500x150 cm / H29.13" 196.85"x59.05"

Cambio low table



Cambio H48 D60 cm /
H18.89" D23.62"

Cambio H48 D70 cm /
H18.89" D27.55"

Cambio H48 D80 cm /
H18.89" D31.49"

Cambio H48 D100 cm /
H18.89" D39.37"



Cambio H48 D120 cm /
H18.89" 47.24"

Cambio H48 70x70 cm /
H18.89" 27.56"x27.56"

Cambio H48 80x80 cm /
H18.89" 31.49"x31.49"

Cambio H48 90x90 cm /
H18.89" 35.43"x35.43"

Connectivity



1. Pop-up sockets
2. USB port
3. Powerbox
4. Pop-up sockets

ALETA

Elegance in the subtle

Collection designed by Jaime Hayon, 2017



If we look for a leitmotif in the Viccarbe collection, that would be the combination of synthetic structures and extra comfortable seats. The simplicity, the contemporary design of its chairs and armchairs comes from the hand of bases that have the precise material to define the use and the function, free of all useless adornment. On the other hand, comfort comes from subtle details on both the inside and outside of each piece. Aleta was born in this way, achieving a perfect balance capable of fulfilling the creative proposal of Jaime Hayon, and the evolutionary proposal of the Viccarbe collection.

"With the international vision, with the mixture of know-how, and of combining different ideas and dialogues, certain products were released with which we are very satisfied today.

As a designer—just like Viccarbe—I'm very functional. Not minimalist, but simple. (...) With Viccarbe, the idea was to find a mutual language. The turning point has perhaps been found by making a few more expressive forms on the chairs or tables we have made, finding a way, a balance for both. I believe that the real collaboration with companies is this: to find a balance."

"The simplicity, the contemporary design of its chairs and armchairs comes from the hand of bases that have the precise material to define the use and the function, free of all unnecessary adornment."



On this page, a picture of Burin table full black with two Aleta chairs metal base, black structure



Comfort comes from subtle details on both the inside and outside of each piece



On the left page, a picture of Burin table in black with Aleta chair, pyramid swivel base. On this page, Aleta chair, flat swivel base, and Aleta chair pyramid swivel base with casters

On these pages, featuring Trestle table and Aleta chair with swivel flat base

The limits between spaces are blurred. Conventional meeting rooms are no longer the only spaces where teams work to transform organizations. We feel more comfortable in familiar surroundings, in places similar to the living room, where we regain confidence in ourselves and feel like participating. We also feel comfortable in relaxed environments such as a café, where we can hold informal meetings where we can take a stance and strengthen ties with other colleagues in the organization.



Aleta & Work

Office — The Aleta chair was born to materialize the perfect balance between functionality and creativity. Aleta works perfectly in any situation: having lunch in a restaurant, an extended meeting at the office or working from home.



Project on top: Vococon Headquarters, Cleveland
Interior Design: Vococon. Pictures: Matthew Carbone

Project on the right: Savills Aguirre Newman
Headquarters - Coffee area



ALETA WOODEN BASE

Warm, elegant, contemporary... The versatility of a chair does not only lie in its initial design. It also lies in the possibility of incorporating different finishes in it. Aleta and its wooden base allow us to play with ambiguity. They give us the possibility to create multipurpose spaces where we are not limited by the use, but inspired by the warmth of the finishes. In this case, it does not matter where we live our day to day life, but the comfort with which we approach it.



On these pages, featuring Burin table and Aleta chair with wooden base

Unwind Hotel Otaru, (Japan)

Hospitality — Unwind Otaru represents the renovation of an old building located in the prefecture of Hokkaido, north of Japan. Its vintage aesthetic combines perfectly with the contemporary furniture and finishes chosen for the new layout. As with the Aleta collection, achieving the right balance is fundamental.



Project on these pages: Unwind Hotel Otaru, Japan
Interior Design: LINE-Inc. Pictures: Kenji Masunaga, Kozo Takayama
Special thanks: Interiors Inc



Projects on the left page: Tago Mago Restaurant, Valencia.

Projects on the right page: La Chipirona Restaurant, Valencia by La Galería Estudio. Picture: Ángel Segura





Projects on these pages: La Chipirona Restaurant,
Valencia by La Galería Estudio. Picture: Ángel Segura



Projects on the left page: The Härg, Estonia. Interior design: Ace of Space + Aap Piho. Dealer: Studio Living. Photographer: Terje Ugandi

Projects on the right page: La Cabra Restaurant, Madrid. Interior Design: Mecanismo. Photographer: Kavi Sánchez



Projects on these pages: Centre Pompidou Café
Le Central, Paris. Project: Hayon Studio
Pictures (interiors): Nienke Klunder





Project on these pages: Reinassance hotel, Barcelona





Aleta Stool



"If we look for a leitmotif in the Viccarbe collection, this would be the combination of synthetic structures and extra comfortable seats."



Project on the left: Spaces Coworking
Wai Yip Street, Hong Kong
Interior design: D&P Associate

Project on the right: AMGEN HQ
Project: The A&M Group



Project on these pages: Goutal flagship store, Hong Kong
Project: VIA Architecture Limited
Photography: VIA Architecture Limited, Marketing Team
Archetypal Limited



Aleta stool at the office

Workspaces — The talent and energy of Jaime Hayon has conveyed to the latest additions of the collection. The Aleta stool is contemporary, warm, and elegant and its stimulating finishes will convert any office space layout.



Project on top: Mc Donald's Headquarters, Chicago
Architecture & Interior Design: Sterling Bay + Gensler
- IA Interior Architects y Studio O+A
Pictures: Mc Donald's

Project on left: Regus Spaces, Belvedere
Interior Architect: D&P Associates

Project: HucCo Coworking Space, New York. Interior
Design: Christina Michelle Interiors.
Photography: Ball & Albanese



An elegant stool to
add character into
any room



Project: Tago Mago Restaurant, Valencia



Project: VIBIA Headquartes, Barcelona
Pictures: Fernando Aida

Aleta *Lounge Chair*

2017 — How to express a lot through a simple piece of furniture? The successful Aleta collection fuses functionality with comfort, rigorous lines with creativity. As in the entire Viccarbe collection, nothing is static: Metal or wooden structure? Seats with or without armrests? If creativity taught us something, it is that we should never give up freedom.



If creativity
taught us
something, it is
that we should
never give up
freedom



On the left, Aleta Lounge chair with brass structure. On this page Aleta Lounge chair and Shape low table



Pictures on these pages: Vertisol Showroom,
Madrid. Project: Odosdesign
Pictures: Javier Guerrero

Aleta lounge chair



Aleta Lounge Chair
metal base



Aleta Lounge Chair
wooden base



Aleta Lounge Chair
metal base & armrests



Aleta Lounge Chair
wooden base & armrests

Aleta stool



Aleta bar stool



Aleta high backrest
bar stool



Aleta swivel
bar stool



Aleta swivel bar stool
high backrest



Aleta swivel bar stool
& armrests



Aleta counter stool



Aleta counter stool
high backrest & armrests



Aleta swivel
counter stool



Aleta swivel counter stool
& high backrest



Aleta swivel counter stool
high backrest & armrest

Aleta low table



Aleta low table

Aleta chair



Aleta chair
metal base



Aleta chair
metal base & armrests



Aleta chair
metal base



Aleta chair
metal base & armrests



Aleta chair
wooden base



Aleta chair
wooden base & armrests



Aleta chair
swivel base



Aleta chair
swivel base & armrests



Aleta chair
pyramid swivel base



Aleta chair
pyramid swivel base & armrests



Aleta chair
flat swivel base



Aleta chair
flat swivel base & armrests



Aleta chair
pyramid swivel base & casters



Aleta chair
pyramid swivel base
with casters & armrests



Aleta chair
five casters base



Aleta chair
five casters base & armrests

BURIN

Shape & character

Table designed by Patricia Urquiola, 2018

“There is a fine line between the ambition to achieve iconic design and functional design at the same time, a line between the personality of the author and the role that a table should play in a collective or private space.”

The rules of the game are broken. The boundaries between spaces are blurred. What in the past we were used to understand as work spaces, today have become friendly living rooms or quiet libraries.

The reference boutique hotels and cafés want to be co-working spaces. Households prepare for co-living. And—above all—they take values such as flexibility for granted.

But in all these spaces, in all these places for people, there is a value sine qua non to the condition of the human being. In all of them there is the search for well-being, self-realization and freedom of expression. In all of them, one expects to experience the feeling of comfort. There is therefore a fine line between

the ambition to achieve iconic design and functional design at the same time, a line between the personality of the author and the role that a table should play in a collective or private space.

With Patricia Urquiola, we learned to look for new ways of constructing, to make use of materials that the classic furniture industry would not have contemplated. We also learned to project a continuity within the collection. In Burin's case, it would happen at the time when we were expanding an existing family, but also with the use of rotational polyethylene in the manufacture of its base. The moment when we opened the doors to this material comes to mind: 2006 gave us the Last Minute stool and its seat in this same rotomolded polyethylene.



On this page set of a Burin table with matt oak table top and black base with Maarten Plastic chairs, sled base

DOUBLE BURIN

It is fascinating how the use of an unusual component has managed to democratize this centrally based table. However, above all, it is interesting how it has happened without losing an ounce of character and differentiation. By giving the possibility of combining its base with more sophisticated boards, we manage to maintain the balance that is created between durability and elegance, no matter if it is in its single, double or triple base version.



On this page, a set of a double Burin table lacquered in black with Quadra chairs in ash



SUBTLE CONNECTIVITY

Additionally, Burin can include electrification systems in a discreet and fully integrated manner, an extra dose of functionality and aesthetics for meeting spaces and large conference rooms.

On the left page, a set of a Burin table lacquered in black with Copa cantilever chairs. On this page, a Burin triple table in black finish with Maarten Plastic chairs, pyramid base and brick seats

An environmentally



friendly process

Rarely does the industrial process of a design make big headlines. However, from the perspective of sustainability, this is precisely the benefit of a design. Industrialization has given us the possibility to make life easier for society and to share our Mediterranean lifestyle. It has opened the door to innovative product categories capable of responding to new contexts, behaviors and moments with the best designers and architects in the world. We learned about artisan processes but, over the years, we found the opportunity to evolve to find ways to create that are more efficient and sustainable over time, ways which are more respectful of the environment.

In the case of Burin, its base is made through a mold in which the pellets are rotated and gradually molded into a base that will later not only be resistant and durable over time for decades, but also totally recyclable. Beauty is, without a doubt, on the inside.

Pictures during the manufacturing process of a Burin table

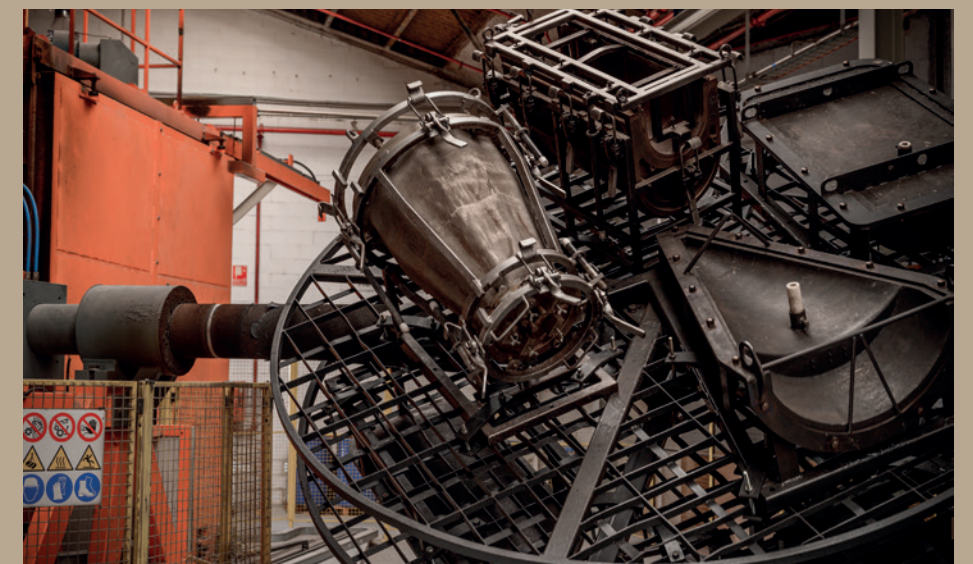

Burin & Food

Restaurants — Thanks to its base, Burin is a table especially suitable for *hospitality* spaces: hotels, bistros, coffee shops... It is easy to clean and very resistant to the course of time.



In these pages, a picture of Burin tables with square matt oak table top and taupe base combined with four-legged wooden Copa chairs



Burin table & Burin Mini



Burin H74 70x70 cm /
H29.13" 27.56"x27.56"

Burin H74 80x80 cm /
H29.13" 31.50"x31.50"

Burin H74 D70 cm /
H29.13" D27.56"

Burin H74 D120 cm /
H29.13" D47.24"



Burin H102 80x80 cm /
H40.16" 31.50"x31.50"

Burin H102 D80 cm /
H40.16" D31.50"

Burin H74 140x140 cm /
H29.13" 55.11"x55.11"

Burin H74 100x100 cm /
H29.13" 39.37"x39.37"



Burin Mini H50 - H55 cm /
H19.69" - H21.95"

Burin Mini H50 + 10 cm (handle) /
H19.69 + 3.94" (handle)

Burin table



Burin double base H74 L240 cm / H29.13" L94.48"
with powerbox

Burin double base H74 L240 cm / H29.13" L94.48"



Burin central base H 74 D150 cm / H29.13" D59.05"
with pop-up sockets

Burin triple base H74 L350 cm / H29.13" L889"
with pop-up sockets

Connectivity



1. Pop-up sockets
2. USB port
3. Powerbox
4. Pop-up sockets

SOLAR

Reach for the Sun

Table designed by Marc Krusin, 2021

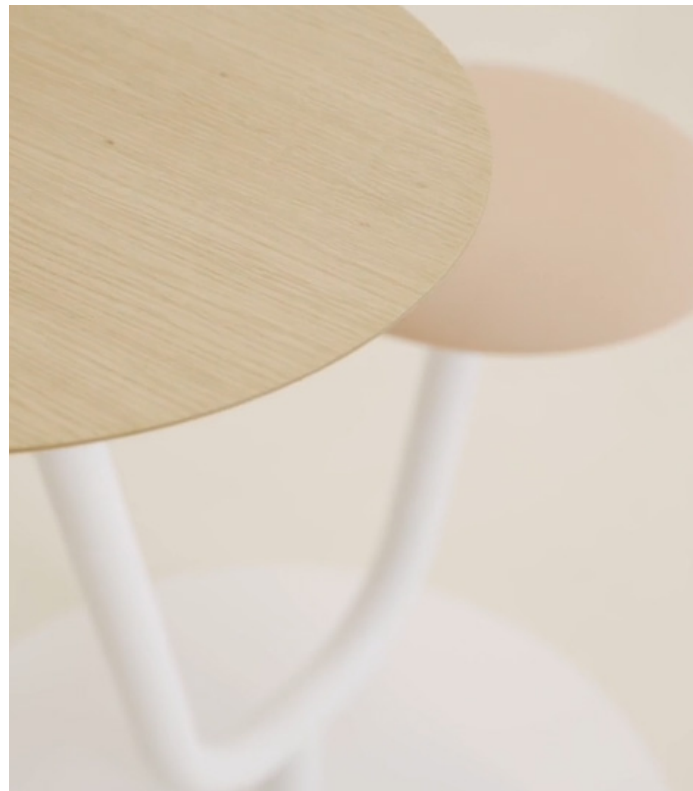

Solar is the result of our relentless search to attain an added value in every new project that we launch at Viccarbe.

A disruptive, out-of-the-box vision, which analyzes human behaviors yet to be resolved, and creates new collaborative models for both Indoor and Outdoor. Solar enhances privacy and collaboration, physical distance, and proximity. A great

all-rounder that connects and brings spaces together. A mix of options due to the simple and sculptural proposal of a swivel table and an integrated seat, that rotates according to the user's requirements when needing to move towards a co-worker or when demanding a dose of sunshine, as an elegant sunflower, to rejuvenate and switch off after several hours indoors.

"A disruptive, out-of-the-box vision, which analyzes human behaviors yet to be resolved, and creates new collaborative models for both Indoor and Outdoor."



OUTDOOR VERSION

Solar for outdoor has a metal structure and a compact tabletop, and its seat can be made in compact or upholstered in any of the available outdoor fabrics.



On these pages, featuring Solar table outdoor version with white structure and upholstered seat

Solar allows you to spin in search of sunlight, a colleague or some privacy



On these pages, Solar with black structure, stained tabletop in cognac and upholstered seat

Privacy

*Retreat outdoor with Solar to disconnect, work, dine or enjoy the alfresco area.
Privacy is always guaranteed.*

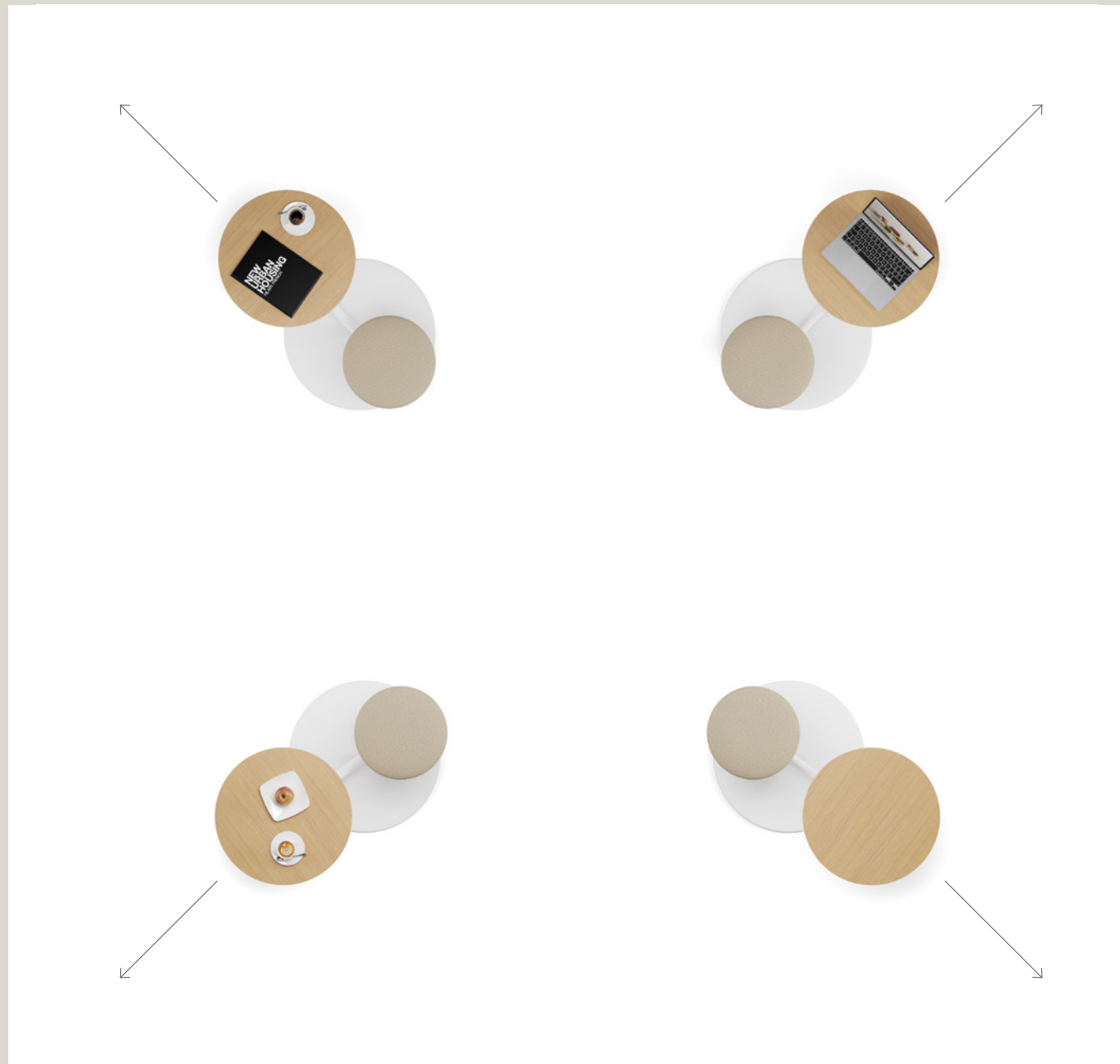

Collaboration

Choose your side with Solar, a clever piece to foster collaboration in team meetings, promote communication and enhance concentration.

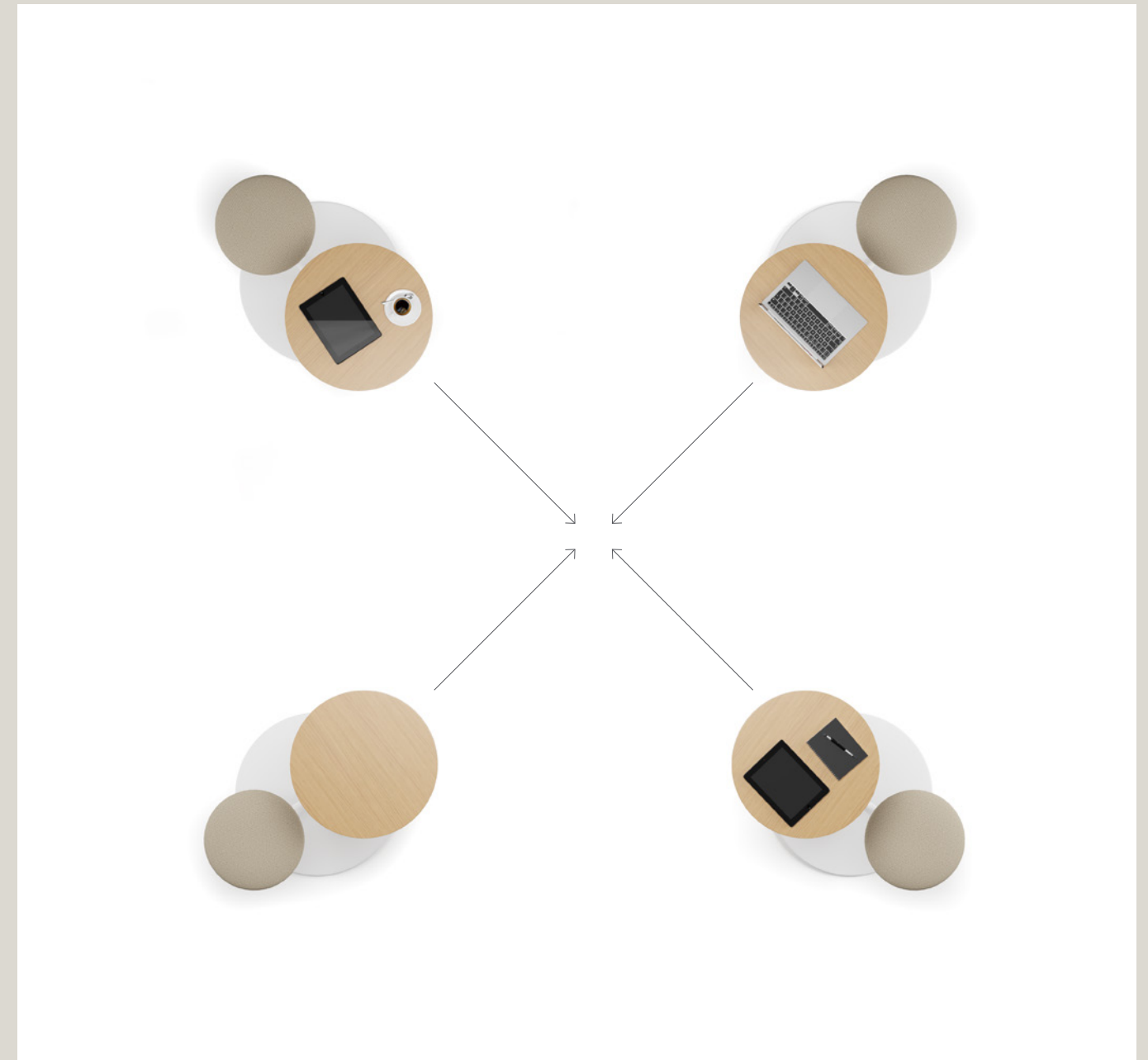

CORPORATE

The exterior is now an extension of the office space. Solar table opens new territories and possibilities to take advantage of the outdoor scene. A place to work, share and create.



On these pages, featuring Solar table outdoor version in white finish

FLEXIBILITY IS COVERED

The disruptive table promotes flexibility in and out. No matter the location, Solar table has got it covered.

On these pages, featuring Solar table outdoor version with black tabletop, white structure and upholstered seat



EDUCATIONAL

Solar table enhances focused and independent work but at the same encourages collaboration thanks to its swivel base. A great flexible piece for classrooms, universities and modern conference rooms.

On these pages, Solar with white structure, stained tabletop in matt oak and upholstered seat

The Battery Pack provides up to 8 days of autonomy



An autonomous & secure USB charging station is available. With the USB pack, the charging unit can be easily installed under the tabletop. 2 USB ports allow fast charging of phones, tablets, power banks and other devices. The Battery Pack is powered by a 15 Ah battery which provides up to 8 days of autonomy depending on its use.

On the left page, Solar table with the charge system battery pack

Charging devices



The Charging tray allows 4 batteries to be recharged simultaneously in 7 hours. It can be used flat or fixed on a wall.



A magnetic key allows you to unlock the battery and extract it in a jiffy to recharge it.



The Battery pack has been designed for professional use. Its reinforced case and its IP 65 certification allow it to be used both indoors and outdoors.

Mix and match all the options available for Solar. You can unleash your imagination to design your bespoke sofa from zero, to best fulfil your requirements or, if you prefer, you can get inspired by a series of pre-defined compositions that will help you bring this collaborative island to life into your projects.

Either way, the final result will be a comfortable table that fosters interaction, well-being and productivity, all in one. A singular collaborative piece that is able to add a contemporary twist to homes, workplaces, hotels and high-traffic environments all around the world.

Solar table



Solar, white seat and compact laminate tabletop



Solar, black seat and compact laminate tabletop



Solar, upholstered seat and cognac tabletop



Solar, upholstered seat and matt oak tabletop



COMMON

Comfort will remain

Bench designed by Naoto Fukasawa, 2013



"Imagine two strangers sharing the same space". This is how Naoto Fukasawa describes the Common Bench in his book Embodiment. Luxury today is measured in the level of enjoyment that the user experiences in a space. No distractions, no restrictions. For this reason, positive behaviors, forms and emotions

contribute to the person's feeling of comfort in external spaces.

Through its different modules and measurements, Common has been able to maintain a common thread, with a silhouette as rotund as it is curved. It is a pole of attraction where only comfort will remain.

"Through its different modules and measurements, Common has been able to maintain a common thread, with a silhouette as resounding it is curved. It is a pole of attraction where only comfort will remain."

Project: Frigicoll Offices, Barcelona
Interior Design: Isabel López Vilalta
Pictures: Salva López



Positive behaviors, forms and emotions contribute to the user's feeling of comfort in external spaces



Project: The Terrazzo Concrete Office
Design: Tal Goldsmith Fish
Pictures: Amit Geron
Project: Alk Reizen
Design: Clara Claes





Project on these pages: Workingshare



Common & Receptions

Offices and Hotels — A design that is capable of balancing spaces, contexts and users, conferring upon them an aura of kindness and serenity.

Project on this page: K12 Studio, Melbourne
 Interior Design: K2LD Melbourne
 Pictures: Jeremy Wright

Project up to the right: IA Architect, New York
 Interior Design: Anderson/Miller in collaboration
 with Gensler. Pictures: Isaac Maiselman

Project on the right: Marriot Marquis Hotel,
 Chicago. Interior Design: Interior Architects, NY
 Pictures: Eric Laignel



Common

Low table

2013 — The new context we are living in today comes as a blank page, as an opportunity to redefine priorities and the very environments in which we live. Although we usually find the Common table completing the needs of the bench, it also has room in very different spaces. Is it possible to breathe a calmer essence? In times of uncertainty, the foundations of Japanese culture and the value of the timeless will give us back that much needed calm after a storm.



Project: Progetti Store

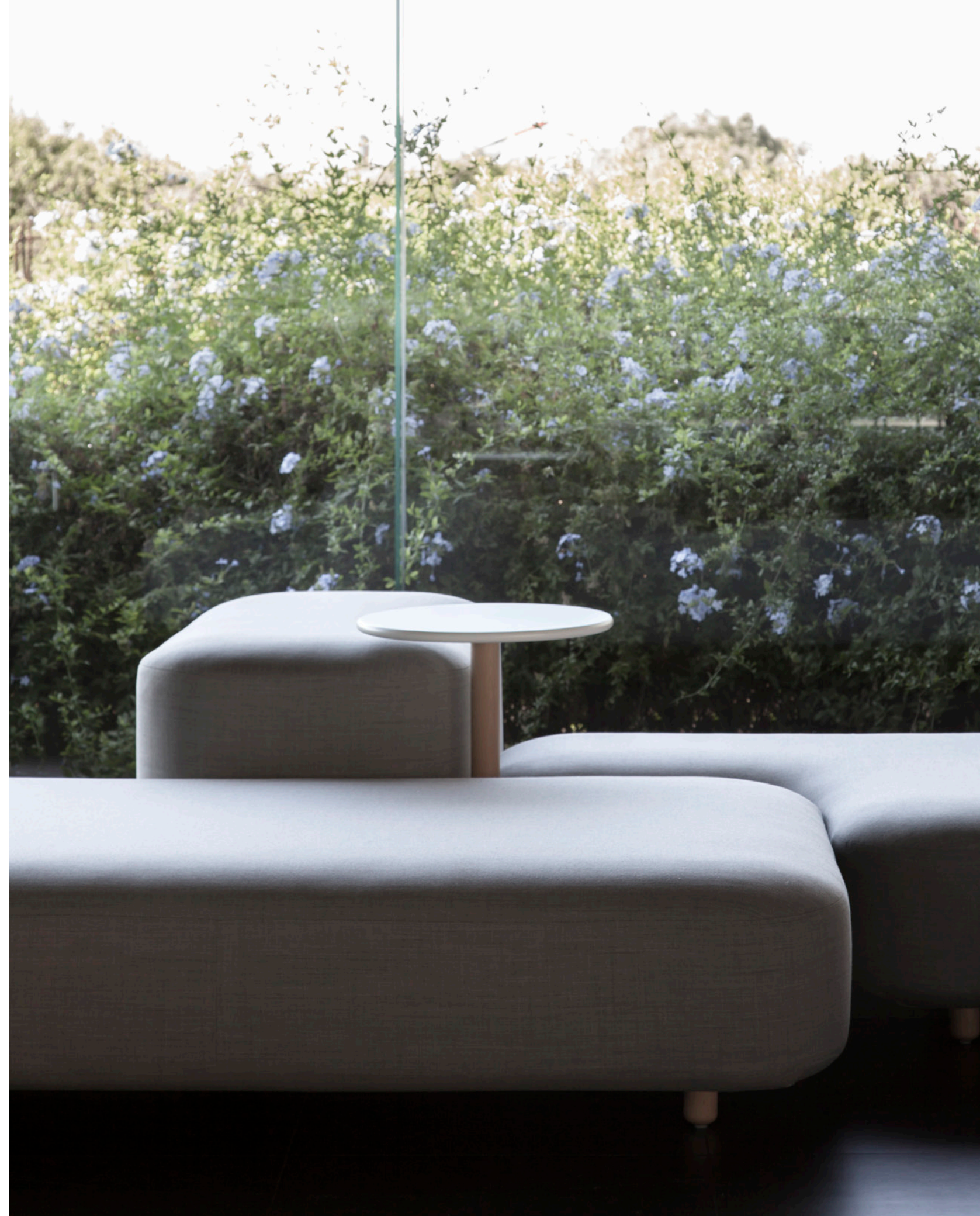

Mix and match all the options available for Common. You can unleash your imagination to design your bespoke sofa from zero, to best fulfil your requirements or, if you prefer, you can get inspired by a series of pre-defined compositions that will help you bring this collaborative island to life into your projects.

Either way, the final result will be a comfortable bench that fosters interaction, well-being and productivity, all in one. A singular collaborative piece that is able to add a contemporary twist to homes, workplaces, hotels and high-traffic environments all around the world.

Common bench



Composition 1



Composition 2



Composition 3

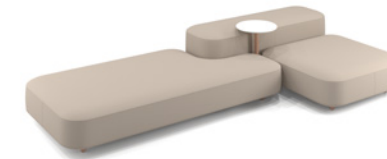

Composition 4



Composition 5



Composition 3

Common low table



Common H45, H17.71"



Common H65, H25.59"

Connectivity (for Common bench)



1. USB port, upholstery



TRESTLE

The perfect balance

Table designed by John Pawson, 2014

“As a table, Trestle manages to raise versatility to its maximum and manages to integrate itself without stridency in all types of spaces.”

The Trestle collection has shown us the balance between architecture, materials and the light that brings them all to life, as a meeting point that, far from making the work of the architect or interior designer difficult, facilitates the path to follow and gives meaning to their projects.

This philosophy, so friendly and connected to simplicity, is what prevails in Pawson's designs. Thus, that warm minimalism that the architect usually uses, free of poses and based on the

essential, shaped the Trestle family in 2014.

With studied proportions, the table has become a meeting place for work colleagues, family members or visitors of a commercial space. It represents a perfect point of connection between the different characters that inhabit a space.

As a table, Trestle manages to raise versatility to its maximum and manages to integrate itself without stridency in all types of spaces.



With Trestle we go back to basics. Its maximum versatility has managed to reinvent the traditional concept of table, matching with every chair of the collection.



On this pages featuring Trestle table in different finishes of the collection

SIMPLE SIZE

Make Trestle as simple or as complex as your space requires, it is made to order. The basic Trestle table can seat up to 8 people. Its distinctive legs bring great design into any room. A functional yet statement table option to use as a desk in offices or as a dining table in restaurants, hotels, or homes. Include electrification and wiring solutions for extra usability.



On these pages, Trestle table
in matt oak finish





DOUBLE SIZE

Choose Trestle double to foster collaboration and teamwork, being able to seat up to 12 people. Functional and visually light, Trestle acts as a convenient center point in meeting rooms, collaborative spaces, co-workings, modern restaurants, cafeterias, and homes. The table can also include electrification and wiring solutions, keeping teams always connected. A versatile and ergonomic table with multiple possibilities.



On this page, Trestle table in black finish



On this page, pictures of the different heights of the Trestle table and Trestle bench

Trestle is resounding but light

Moreover, we can safely say that in recent years it has been able to grow. It has been able to understand, to listen to different needs that emerged on its way. Today there are three heights available for the table: 74cm, 88cm (counter), and 105cm (bar). Quite a statement of intent as far as adaptability is concerned. There is no environment where Trestle doesn't fit in: it is resounding, but light. It is functional, but elegant. It is minimalist, but extremely comfortable.



74 cm | 29,13"



88 cm | 34,64"



105 cm | 41,33"

On this page, pictures of the different heights of Trestle table



On this page, a set with a Trestle table lacquered in taupe H105 cm | 41.33" and four Maarten Plastic bar stools, white sled base and ochre seat

Home/Work

The ideal office today is a daytime living room, where work can be done under less stress and no distraction.

The focal point of the home of the future will not be the formal dining room, nor the overloaded style foyer. It will be a multifunctional room, where there is space for disastrous hobbies, easy

to clean surfaces and furniture full of personal items. Work happens at home, and home is constantly moving to work.

In both environments, we need details such as retractable legs, plugs elegantly camouflaged with finishes, and even seemingly dispensable table lengths. With Trestle, it is possible.



2014 — The Trestle bench represents a true ode to collaboration, familiarity and shared spaces. Perfect to be placed next to the table of the same collection, or separately for transit spaces, this piece breathes the same essence that we find in all the elements designed by Pawson. Once again we enjoy an exercise in maximum functionality and minimum prominence. Trestle was born for sociable spirits, for collective spaces.



On this page, Trestle table & bench





TRESTLE LEGS

Minimalist finishes for maintaining the philosophy of John Pawson. As an authentic best seller, it is available with metal legs, (in white or black) and solid oak.



Solid Oak - Matt Oak



Metal legs - black



Metal legs - white



Featuring Trestle table, Funda chair and Trestle bench

Trestle & Work

Meeting Areas — Trestle can be integrated naturally in any environment, with both fierceness and discretion. A staple to generate synergies in collaborative spaces where ideas are brought to life.



Project: Money Super Market Office, London
Interior Design: BDG architecture + design
Pictures: Jefferson Smith



On this page, a picture of a white lacquered Trestle table with electrification and Copa chairs pyramidal base & casters



Trestle

Bench

2014 — The Trestle bench represents a true ode to collaboration, familiarity and shared spaces. Perfect to be placed next to the table of the same collection, or separately for transit spaces, this piece breathes the same essence that we find in all the elements designed by Pawson. Once again we enjoy an exercise in maximum functionality and minimum prominence. Trestle was born for sociable spirits, for collective spaces.



On the right page, a picture of a triple Trestle table with upholstered Trestle bench and ash Quadra chairs



Project: L'Antic Colonial Showroom, Castellón
By Fran Silvestre Arquitectos



This piece breathes
the same essence
that we find in all the
elements designed
by Pawson



On this page, a picture of Trestle bench with padded
and smooth upholstered



On these pages Trestle bench with smooth upholstered seat and wooden legs



On the left Trestle bench with smooth upholstered seat and ash wooden legs. On the left Trestle bench with padded upholstered seat and ash wooden legs.

INFINITE COMPOSITIONS

Moreover, we can safely say that in recent years it has been able to grow. It has been able to understand, to listen to different needs that emerged on.



Trestle table



Trestle table H74 200x90 cm /
H29.13" 78.74"x35.43"

Trestle table H74 200x120 cm /
H29.13" 78.74"x47.24"

Trestle table H74 240x90 cm /
H29.13" 94.48"x35.43"

Trestle table H74 240x120 cm /
H29.13" 94.48"x47.24"



Trestle table H74 360x90 cm /
H29.13" 141.73"x35.43"

Trestle table H74 360x120 cm /
H29.13" 141.73"x47.24"

Trestle table H74 480x90 cm /
H29.13" 188.97"x35.43"



Trestle table H74 480x120 cm /
H29.13" 188.97"x47.24"

Trestle table H74 480x120 cm /
H29.13" 188.97"x47.24"

Trestle bench



Trestle bench simple,
smooth upholstery

Trestle bench simple,
padded upholstery

Trestle bench double,
smooth upholstery

Trestle bench double,
padded upholstery



Trestle bench infinity,
smooth upholstery

Trestle bench infinity,
smooth upholstery

Connectivity (for table)



1. USB port
2. Powerbox
3. Powerbox under top
4. Battery pack
5. Wire management leg

SISTEMA

Infinite modularity

Collection of sofas designed by Lievore Altherr Molina, 2016

"Vicarbe's quest for comfort brought us to create Sistema in 2016 - a modular sofa which fits very diverse environments, needs and situations."



In these pages, a picture of different compositions of the Sistema Legs sofa with scissor legs and soft finish

Legs



Sistema Legs gives the possibility to choose between three different types of legs depending on the form: scissors, cylinder and flute - Offering great durability and adaptability to diverse environments. Available both in Smooth and Soft upholstery.

Floor



The definitive approach to the aesthetics of a residential sofa. Perfect for an additional degree of elegance thanks to its fully upholstered modules. Available both in Smooth and Soft upholstery.

Soft



A meeting point between rationalism and warmth. Sistema Soft emerges as an evolution of the Sistema sofa, presenting a more comfortable interior, as well as a more wrinkled effect in its upholstery, one that is therefore more welcoming.

Smooth



Great durability and adaptability to diverse environments. Sistema, with its smooth upholstery, is a perfect choice for commercial spaces, offices, or airports. High traffic areas where privacy and dynamism sometimes become a sine qua non.

MULTIPLE COMBINATIONS

It is well known that flexibility is creatives' best friend. But it is also true that a simple process together with a selection of deeply thought components become very much appreciated ingredients in project development. For this reason, we have spent the last months rethinking one of Viccarbe's best-sellers and singular pieces: The Sistema sofa. The engineering and manufacturing process of Sistema has been highly optimized. *"Because we believe that the only constant is change and because there is still so much to be done. This is, and will continue to be, a living history."*

In these pages, an image of different compositions of the Sistema Legs sofa with scissor legs and soft finish



Create your own configuration

Sistema components

In these pages, a diagram of the elements that compose the Sistema collection

1

Modules

- A. Backless module
- B. Medium backrest module
- C. High backrest module
- D. Corner

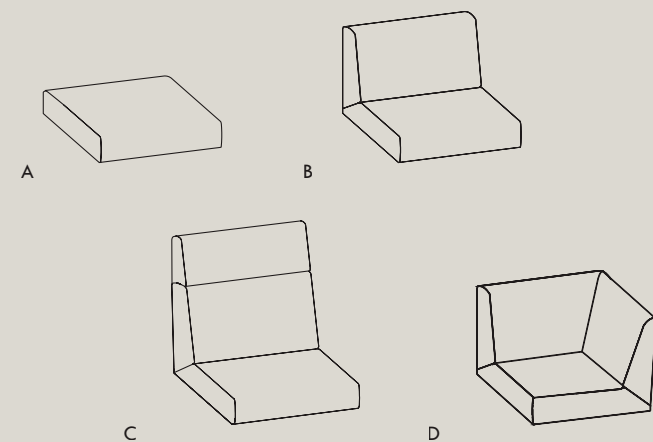

Arms

- P. High armrest upholstered-wood / fully upholstered
- Q. Curved wooden arm
- R. Curved upholstered arm
- S. Narrow arm
- T. Wide arm

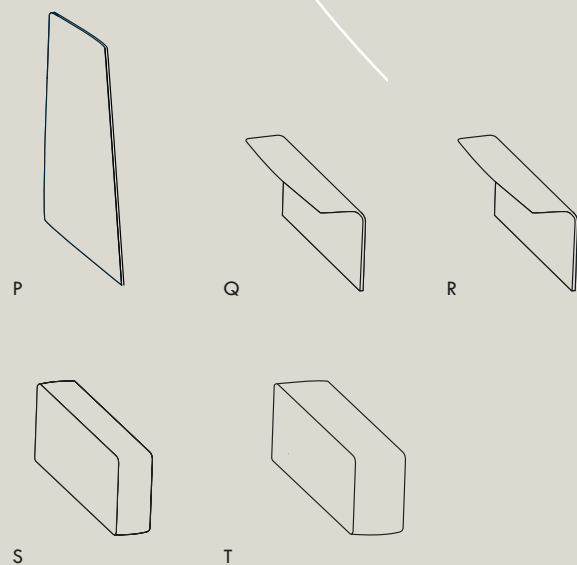

2

Legs

- E. Cilinder legs
- F. Flute legs
- G. Scissors legs

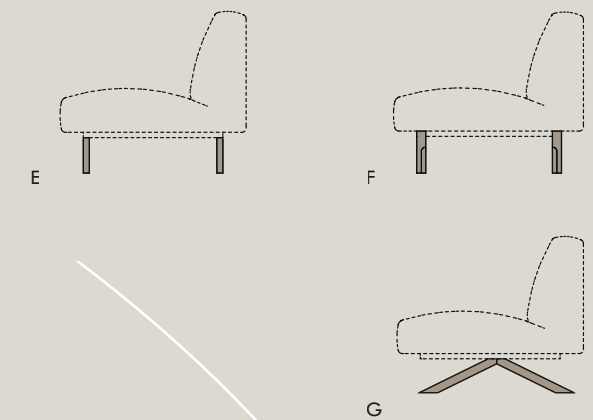

Tables & accessories

- H. Wooden box table
- I. Low table
- J. Free table
- K. Free arm
- L. Cushion
- M. Headrest
- N. Squared pouf
- O. Round pouf

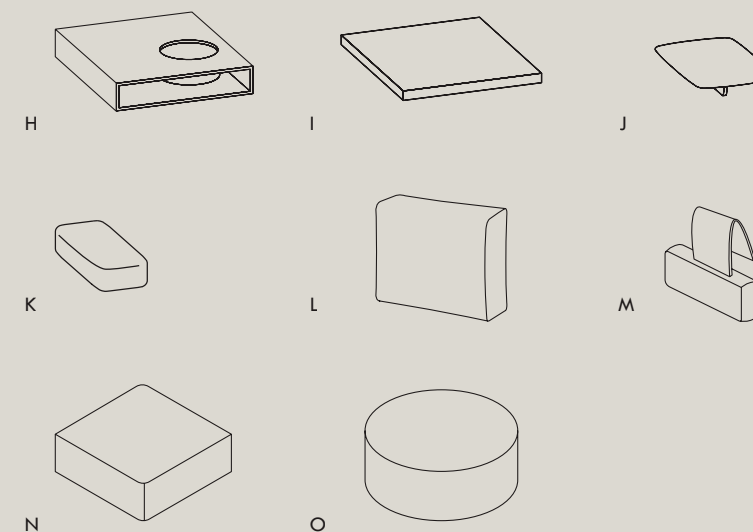

4

3

SISTEMA LEGS

Sistema Legs gives the possibility to choose between three different types of legs depending on the form: scissors, cylinder and flute - Offering great durability and adaptability to diverse environments. Available both in Smooth and Soft upholstery.



In these pages, a picture of Sistema Legs with soft upholstery and scissor legs with Maarten low table

INFINITY CORNER

Back in 2006 we created Sistema, the modular sofa capable of meeting different requests and fitting into very diverse contexts and environments. We believe that simplicity combined with a careful selection of components or pre-configured elements help to gain agility during the management and development of projects. The Sistema corner makes the most of any space, ensuring comfort and allowing for infinite compositions.

On this page, a picture of the Sistema Legs' corner with soft finish and scissors legs



On this page, a picture of a composition of Sistema Legs sofa with soft finish and scissor legs with an upholstered curved arm. On the right, detail of the electrification with the powerbox under seat





Offering great durability
and adaptability to diverse
environments

In these pages, an image of different
compositions of the Sistema Legs sofa with
scissor legs and soft finish



On this page, a picture of a composition of Sistema legs sofa with soft finish and scissor legs with an upholstered curved arm. The low table is Trino.

Great for receptions, lounging areas and hybrid spaces

The Sistema collection designed by Lievore Altherr Molina has new family members: a refined armchair with scissor legs and a practical auxiliary table to work comfortably whilst sitting on the sofa from the same range.

The comfortable design armchair with scissor legs can include wooden or upholstered armrests, a versatile detail that facilitates individual work and long conversations at the office. Great for receptions, lounging areas and hybrid spaces.



On the right Sistema armchair with arms
and scissors legs in black

The Sistema Legs armchair allows you to work comfortably and relax in any corner. With friendly shapes for the home, elegant lines for office environments, and a comfortable appeal for hospitality spaces. Sistema Legs includes practical armrests, available in different versions, fitting in all kinds of contexts.



On these pages, featuring Sistema armchair and Ryutaro table



On these pages, featuring Sistema sofa,
Trino low table and Maarten low table

Ensuring comfort
and allowing for
infinite compositions



On these pages, featuring Sistema sofa and
armchair, Serra low table and Cambio low table



Sistema is a great choice
for reception areas or
management offices

CORPORATE

Choose from an infinite variety of compositions that are durable and perfectly adapted to the look and feel of the company. Sistema is a great choice for reception areas, management offices, or the collaborative spaces of large offices.

In these pages, an image of different compositions of the Sistema Legs sofa with scissor legs and smooth finish

In these pages, an image of different compositions of the Sistema Legs sofa with scissor legs and smooth finish



In these pages, an image of different compositions of the Sistema Legs sofa with high backrest, high arms and wooden finish



SISTEMA FLOOR

The definitive approach to the aesthetics of a residential sofa that works also for workspaces, receptions and collaborative areas. Perfect for an additional degree of elegance in the living room and welcome areas thanks to its fully upholstered modules.



In these pages, composition of Sistema Floor sofa with soft finish and round pouf

The definitive approach
to the aesthetics of a
residential sofa



In these pages, an image of different
compositions of the Sistema Floor sofa
with smooth finish

SISTEMA AREAS

DISCOVER ALL THE POSSIBILITIES

RESIDENTIAL

The rationalist and contemporary nature of Sistema can fit in perfectly with the warm atmosphere of a home. Here, it's just a matter of choosing the right finishes.



PUBLIC SPACES

Sistema gives us the possibility of incorporating backrests of different heights, or accessories such as armrests and auxiliary tables; perfect choices for use in transit areas such as airports, shopping centers, or hospitals.

Project: Otemachi Place, Tokyo
Pictures: Nacasa and Partners
Special thanks: Interiors Inc

CORPORATE

Choose from an infinite variety of compositions that are durable and perfectly adapted to the look and feel of the company. Sistema is a great choice for reception areas, management offices, or the collaborative spaces of large offices.



Project: Cotonella Offices, Italy
Architecture: J+S Architecture & Engineering
Interior Design: FASEMODUS + Studio AI Milano
Pictures: Lea Anouchinsky



HOSPITALITY

In the lobby of a hotel or the sophisticated interior of a cruise... We offer greater privacy to the user, and an enveloping experience thanks to our high arm system.

Sistema Floor



Sistema Floor, Composition 1



Sistema Floor, Composition 2



Sistema Floor, Composition 3



Sistema Floor, Composition 4



Sistema Floor, Composition 5



Sistema Floor, Composition 6

Sistema armchair



Sistema armchair,
curved wooden arms



Sistema armchair,
narrow arms



Sistema armchair,
upholstered wooden arms



Sistema armchair,
upholstered curved
wooden arms



Sistema armchair,
high upholstered arms



Sistema armchair,
high backrest upholstered
curved wooden arms

Sistema Legs



Sistema Legs, Composition 1



Sistema Legs, Composition 2



Sistema Legs, Composition 3



Sistema Legs, Composition 4



Sistema Legs, Composition 5



Sistema Legs, Composition 6



Sistema Legs, Composition 7



Sistema Legs, Composition 8



Sistema Legs, Composition 9



Sistema Legs, Composition 10



Sistema Legs, Composition 11

Connectivity



1. Free table with USB port
2. Powerbox and USB port under seat

Sistema

Bench

2016 — The spaciousness of the seating modules for the Sistema collection makes the bench an authentic place for meetings and having a break. It is a perfect island to complete spaces such as museums, hotel lobbies or even airports. Play with the components of the collection (such as the table module, the container or even the "free" arm) to surprise users in design and function.



In these pages, two Sistema benches, one with scissor legs and wooden auxiliary table and the other with standard legs

A great seating solution
for high-traffic spaces
such as museums, hotel
lobbies and airports

In these pages, a picture of Sistema bench with
scissor legs and stained ash low tables





Sistema bench



Sistema bench,
single module



Sistema bench,
Composition 1



Sistema bench,
Composition 2



Sistema bench,
Composition 3



Sistema bench,
Composition 4



Sistema bench,
Composition 5



Sistema bench,
Composition 6

Connectivity



1. Free table with USB port
2. Powerbox and USB port under seat

EARS

Elegance in the subtle

Chair & Stool designed by Piero Lissoni, 2020



The new chair by the versatile Piero Lissoni joins the collection with the soul of a true icon. Ears is as light in terms of materials as it is resistant to aging. Its sinuous shapes keep intact a style capable of taking us back in time to the contemporary classics of the 70s.

Its balanced arrangement (as reduced as it is comfortable) makes Ears a perfect option for different collective and private areas: meeting points, cafeterias, auditoriums, waiting rooms,

educational spaces, work areas in libraries or lounges.

It is possible to choose oak wood finishes for the entire product, as well as combining its oak seat and metal structure. Both versions of the chair can be complemented with distinctive armrests, designed to embrace the user. This new chair designed by the Italian architect means going back to the roots of industrial design, a tribute to the shapes and materials that so inspired Viccarbe's beginnings in the furniture industry.

"Ears is as light in terms of materials as it is resistant to aging. Its sinuous shapes keep intact a style capable of taking us back in time to the contemporary classics of the 70s."



THE FAMILY

Ears, the family composed of chair and stool and devised by Piero Lissoni, joined the collection with the soul of a true icon. Its sinuous shapes keep intact a style capable of taking us back in time to the contemporary classics of the 70s.



Ears family composed of chairs and stools with bar and counter height in black and white structures.

A touch of wood for collective or individual areas



On this page, Ears chair with four wooden legs in white
ands arms and Ears chair with four wooden legs with
arms, stained i n matt oak

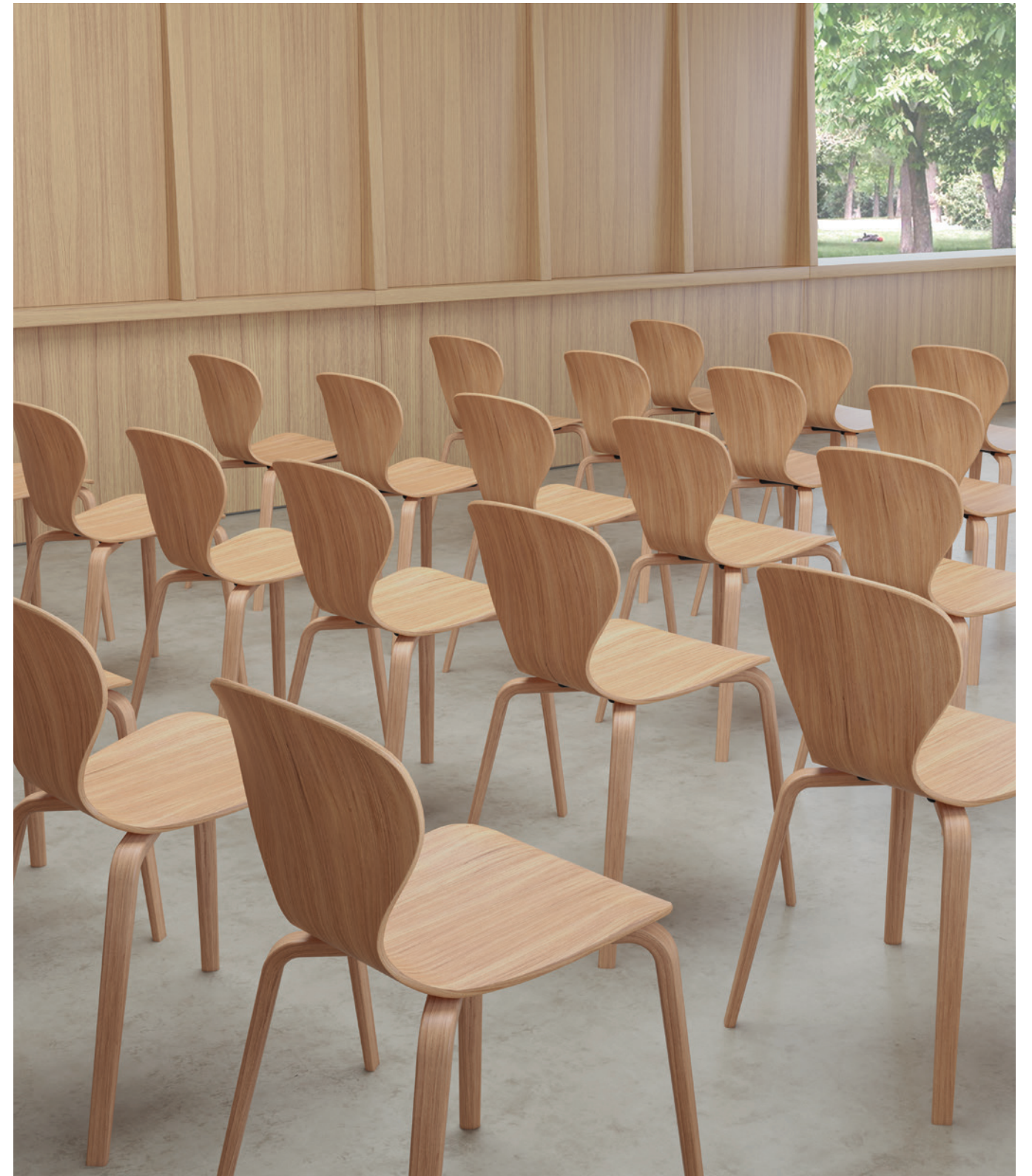

On this page, a picture of an auditorium with Ears
chairs, wooden base stained in matt oak



Ears stool

"The Ears stool is available in two heights (bar and counter), and four metal legs."

Project: Z Private Lounge. Interior Design: Destilat
Pictures: Monika Nguyen





Ears chair



Ears 4 wooden legs



Ears 4 wooden legs & arms



Ears 4 wooden legs



Ears 4 wooden legs



Ears 4 wooden legs with cushion



Ears 4 metal legs & wooden arms



Ears 4 metal legs



Ears 4 metal legs



Ears 4 metal legs smooth upholstery



Ears 4 metal legs arm table

Ears stool



Ears counter stool 4 metal legs



Ears bar stool 4 metal legs & arms



Ears bar stool smooth upholstery



Ears bar stool with cushion

Versatile collections

VICCARBE KITCHEN

The kitchen is the heart of the home, it is a way of living, a place to gather, celebrate and share. We need kind and flexible pieces to feel at ease and make the most out of any space. Finest materials to combine beauty with functionality. Timeless designs that adapt to any situation and reflect the Mediterranean lifestyle. Flexible furniture to add an outstanding value to your home.



Scan to view catalogue

COPA

Comfort at first sight

Collection designed by Ramos&Bassols, 2019

“The simplicity, the contemporary design of its chairs and armchairs comes from the hand of bases that have the precise material to define the use and the function, free of all unnecessary adornment.”

Designed by Ramos&Bassols, the Copa family joined to the collection to represent the best version of comfort. Moreover, in very little time it has managed to become one of our best sellers. It has home friendly shapes, elegant lines for office environments and especially sensual for spaces dedicated to hospitality. Its generously proportioned seat has been able to convince all kinds of audiences. This is so because, visually, its design is a promise of comfort. It is the headline of a story that was just coming up.



COPA WOODEN BASE

The combination of effortless forms and subtle details in turn results in a very balanced design with little extravagance. The Ramos&Bassols studio has conceived this multi-purpose seat as the perfect ally when looking for comfort in the work space.



Set of Copa chairs wooden legs stained in ash and Burin table lacquered in black

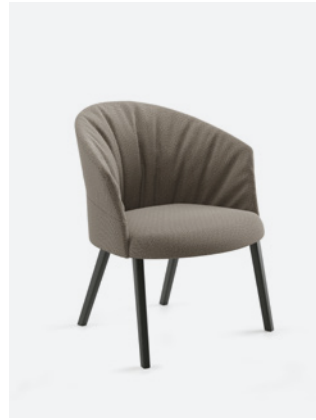

COPA SOFT

Meet the Copa Soft, with a silhouette that is even more comfortable, inviting and enveloping for the collection of wide and finely balanced collaborative seats designed by Ramos & Bassols. Copa evolves as a tribute to extreme comfort, making users want to collaborate and remain seated for hours.

We incorporate a two-tone backrest to the collection, offering the possibility of combining leather and eco-leather on the exterior with any of the fabrics in our range in the interior part, enhancing its uniqueness.

The Copa Soft is incorporated to all the pieces in the collection - chair, lounge chair and stool in counter & bar height - and can be combined with any of the available bases. A versatile design without stridency, prepared to be part of new and exciting ancillary projects all around the world.

“Its “soft” upholstery is pure sophistication, managing to convince the users at first sight and also fulfilling its promise the moment they finally sit down on it.”

Copa & Work

Office — A timeless design offering supreme comfort in any situation thanks to its elegant, surrounding, and sinuous silhouette.



On this page, a picture of Copa chair cantilever base.
Below, a picture of Trestle table and Copa chairs with flat base



Its sinuous design is
a promise of comfort

On this page, a picture of Burin tables with taupe finish
with Copa chairs pyramid swivel base with casters



Copa Soft stool

“The Copa stool becomes the square of the circle for the successful family designed by Ramos&Bassols. This new version of the seat represents one of the maxims of the Viccarbe collection: to continue the journey of existing families, providing greater versatility and adaptability to spaces.”

On this page, a picture of Copa bar stools with four wooden legs base





On the left, Copa stool with 4 wooden legs. On the right Copa stool with 4 metal legs

Copa & counter

Office — Thanks to its wide seat, the stool is as comfortable as the chair, ideal for canteens, coworkings and bar areas.



On the left page, a set of Copa Lounge Chair wooden legs and Trino low tables.



Copa *Lounge Chair*

2020 — With an elegant wooden four-legged base, this design landed in our collection keeping proportions and comfort as the main premises. Its height (slightly lower than that of the chair) is perfect for collaborative areas or spaces in between. It has been shown that, at a lower altitude, there is a greater likelihood of reaching a greater understanding between people.



Its slightly lower height is ideal
for collaborative spaces and
welcome areas



On the right page, a set of Copa Lounge
Chair wooden legs

Copa stool



Copa soft bar stool,
4 metal legs



Copa bar stool,
4 wooden legs



Copa soft bar stool,
4 wooden legs



Copa bar stool,
swivel base



Copa soft bar stool,
swivel base



Copa counter stool,
4 metal legs



Copa counter stool,
4 wooden legs, ash



Copa counter stool,
4 wooden legs, matt oak



Copa counter stool,
swivel base

Copa chair



Copa soft chair,
4 metal legs base



Copa chair,
wooden base



Copa soft chair,
wooden base



Copa chair,
pyramid swivel base



Copa soft chair,
pyramid swivel base



Copa soft chair,
cantilever base



Copa chair,
cantilever base



Copa soft chair,
flat swivel base



Copa chair,
flat swivel base



Copa soft chair,
pyramid swivel base with casters



Copa chair,
pyramid swivel base with casters



Copa chair,
five casters



Copa chair,
five casters

Copa Lounge Chair



Copa lounge chair,
wooden base



Copa soft lounge chair,
wooden base

Tablet arm chair: enhanced productivity and comfort

EARS CHAIR, KLIP CHAIR & MAARTEN PLASTIC CHAIR

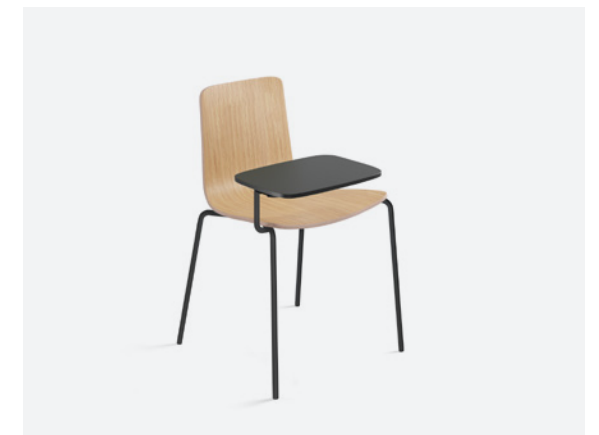
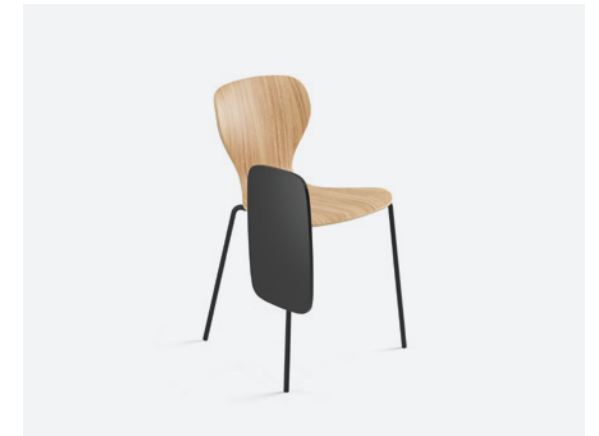

We have included the option of having a tablet arm for our iconic collections such as Ears, Klip and Maarten Plastic. An extra dose of functionality and comfort for classrooms, conference or meeting rooms and a great solution for the present time.

On this page featuring Ears chair, Klip chair and Maarten Plastic chair with table arm

MAARTEN PLASTIC

Proving less is more

Collection designed by Victor Carrasco, 2019



Within the Viccarbe collection, Maarten breathes the spirit of optimism, the freshness of a talent that, despite its youth, is capable of fitting among the most veteran of democratic design. No matter which element of the family we choose, we can always talk about its friendly silhouette and its seat of symmetrical shapes that has now included a sustainable polypropylene to

its range of available finishes. Plastic is a clever ingredient when designing democratic and long-lasting furniture. But, it needs to be recyclable and -if possible- recycled. It's all about durability. Now you can also add an upholstered cushion to your seat and oak finish armrests as an unexpected counterpoint to the plastic, or add four wooden legs for both the chair and stool.



“Maarten Plastic, so much more than a plastic chair, an affordable and versatile piece for lived and loved spaces.”

In these pages, Maarten Plastic chair, pyramid base and Trestle table

On this page, a group of Maarten chairs with pyramidal swivel base in black and white finish and wooden arms



Maarten Plastich with swivel base, pyramidal base and swivel base with wooden arms



Image of a coffee place with Maarten
Plastic chairs, pyramid base



The black shells that we produce are made with 100% recycled polypropylene

The black shells of the Maarten Plastic chairs that we produce are made with 100% recycled and recyclable polypropylene. One more step in our journey to sustainability, optimizing the production process of our pieces so that they generate the least possible environmental impact, using materials that are more respectful with nature.





Maarten Plastic & Learning

Educational Spaces — Which are the benefits of polypropylene over upholstery for educational spaces? All of them and many more: lightness, simplicity, resistance and without a doubt, ease of cleaning.

On this page, a picture of an auditorium with Maarten Plastic chairs, tablet arm and sled base



On this page, a picture of Maarten table with casters in white finish with Maarten Plastic chairs, pyramid base



On this page, a group of Maarten chairs with tablet arm

On this page, a group of Maarten chairs with sled base and different colors



Featuring Maartel Plastic with sled base
in white finish and Trestle table





On the left page, featuring Maarten Plastic
4 wooden legs and dusty green seat and
Trestle table

On this page, a group of Maarten chairs with different bases and colors



On this page, Maarten Plastic pyramidal swivel base with casters, 4 wooden legs with cushion and sled base



On these pages featuring Maarten Plastic with
pyramidal swivel base with casters and Maarten
table with casters



A picture of Trestle table in ash finish, completed with Maarten Plastic chairs with pyramid base, casters, upholstered cushion and some with wooden armrests.





MAARTEN STOOL, STACKABLE

The polypropylene casing also suggests comfort through the color range chosen for the family, based on shades which are capable of transporting us to that tranquility that is always provided by the natural, for it is well known that the Mediterranean is no place for stridency.

What would happen to the polypropylene seats if they did not include the stacking option? Maarten Plastic was born with the call of making everything easier, including the organization. You can stack up to 10 chair units thanks to its lightness and easy transportation.



On the left, a picture of stacked sled base Maarten chairs and stools. On this page, Maarten Plastic stools

Maarten Plastic stool



Maarten Plastic swivel bar stool with wooden arms

Maarten Plastic swivel bar stool with cushion

Maarten Plastic bar stool sled base, low backrest

Maarten Plastic bar stool 4 wooden legs, low backrest

Maarten Plastic bar stool swivel base, low backrest



Maarten Plastic swivel counter stool



Maarten Plastic swivel counter stool with cushion



Maarten Plastic counter stool sled base, low backrest



Maarten Plastic counter stool 4 wooden legs, low backrest



Maarten Plastic counter stool swivel base, low backrest

Maarten Plastic chair



Maarten Plastic chair 4 legs base

Maarten Plastic chair sled base

Maarten Plastic chair sled base with cushion

Maarten Plastic chair pyramid swivel base

Maarten Plastic chair pyramid swivel base & wooden arms



Maarten Plastic chair flat swivel base



Maarten Plastic chair swivel base & arms



Maarten Plastic chair swivel wooden base



Maarten Plastic chair swivel wooden base & wooden arms



Maarten Plastic chair 4 wooden legs



Maarten Plastic chair five casters base



Maarten Plastic chair pyramid swivel base with casters



Maarten Plastic chair pyramid swivel base with casters & wooden arms



Maarten Plastic chair 4 legs base with arm tablet

MAARTEN

Contemporary minimalism

Collection designed by Victor Carrasco, 2012

“From the very beginning, with the Maarten collection, we placed the people who would enjoy sitting on it at the very center of the equation.”

Maarten's story is one of contained minimalism: surprisingly synthetic in its silhouette but extraordinarily welcoming in its soft version.

Since 2012, Victor Carrasco decided to play with the contrast of a very defined structure and an upholstery that spared no wrinkles. It is an upholstery that is pleasant to the touch as well as to the eyes, a seat that invites you to stay in it for hours, and that—depending on the base you choose—is capable of immersing you in the intimacy of a residential space, in the versatility of an installation or in the comfort that projects dedicated to hospitality seek.

“I understood we needed a timeless chair with comfortable forms, as the market was forgetting the universal fact that the human being is more important than the object. 1970s silhouettes, polished but wrinkled at the same time, were starting to be forgotten. And the

design industry was paying more attention to rigorous forms: very focused on aesthetics, but almost inhuman.

I also wanted to pay a tribute to the Belgian designer Maarten van Severen, who had passed away not long ago. He was pure elegance, representing a warm minimalism which deserved all my respect.”

No one ever knew more about how to adapt an object into a space to a space nor on how to attract the attention of acquaintances and outsiders. From the very beginning, the collection wanted to put the people who would enjoy it at the center of the equation. There is no design which is easier to understand than that of a chair. However, there is nothing more complex than designing “for and towards comfort”. For this same reason, in order to adapt to all kinds of moments and contexts, we have recently added new bases: pyramidal, pyramid with casters, flat, sled or four wooden legs. There is a free choice on this subject.

On this page, a picture of Maarten chair with soft upholstery and Maarten table stained in matt oak



MAARTEN SOFT

Maarten was born as a family capable of offering both comfort and resistance and durability. Its "soft" upholstery is pure sophistication, managing to convince the users at first sight and also fulfilling its promise the moment they finally sit down on it. Designed by Victor Carrasco, the Maarten "soft" chair is an ode to comfort that persists over time. Maarten is the perfect fusion of character and functionality.



The family has multiplied exponentially since its inception. With the soul of a bestseller, Maarten is now present in the offices of leading firms such as Dropbox and IBM as well as in the meeting rooms of major international architecture firms.



On this page, a picture of Maarten table stained in ash and casters with Maarten soft chairs, pyramid base with casters and wooden arms



On this page, a picture of Maarten chair pyramid base, soft upholstery and wooden arms. Below, Maarten chair with different bases and upholstery



Maarten & Food

Restaurants — Our lifestyle speaks about our experiences and moments, what determines the space around us and how we share it. In the hospitality projects, a simple detail such as a rotating base allows guests not only to increase their sense of comfort, but also to enhance their communication. The warmth lies in the small details.

Project: Vaqueta Gastro Mercat, Valencia
Interior Design: Janfri & Ranchal Studio
Pictures: Kike Jaen



Maarten *Table*

2014 — Maarten is a design that allows us to have infinite uses, as well as apply as many different finishes and measures as we need for our spaces. Its synthesis and minimalist character contrast with the ease of connection with the user. This family of tables knows how to put values such as closeness into practice.. It does not conform to usual shapes like a circle or a rectangle. Its surfaces range from large diameters to reduced widths, always with perfectly imperfect shapes, which are capable of going beyond the norm and approaching the most human facet of design.



On this page, a picture of Maarten table stained in matt oak with Maarten chairs, swivel wooden base. On the right, a picture of Maarten table with rectangular table top in white finish. Maarten Plastic chairs, sled base full white



Maarten

Low table

2014 — In its auxiliary version, Maarten stands out for its large and light proportions. As an agora, it is capable of becoming a central space, a meeting point for books, coffees and other decorative objects that give personality to the home or the in-between space in which it is framed.



On this pages, Maarten Low table in ash and Funda lounge chairs with black structure



Maarten stool

"Giving support to bar areas, casual meeting spots, canteens and cafeterias, the Maarten stool completes the family and brings new solutions for intermediate spaces. Available with two backrest heights, the stool adds comfort and a touch of contemporary minimalism wherever needed. A great option to foster collaboration and promote the exchange of ideas."

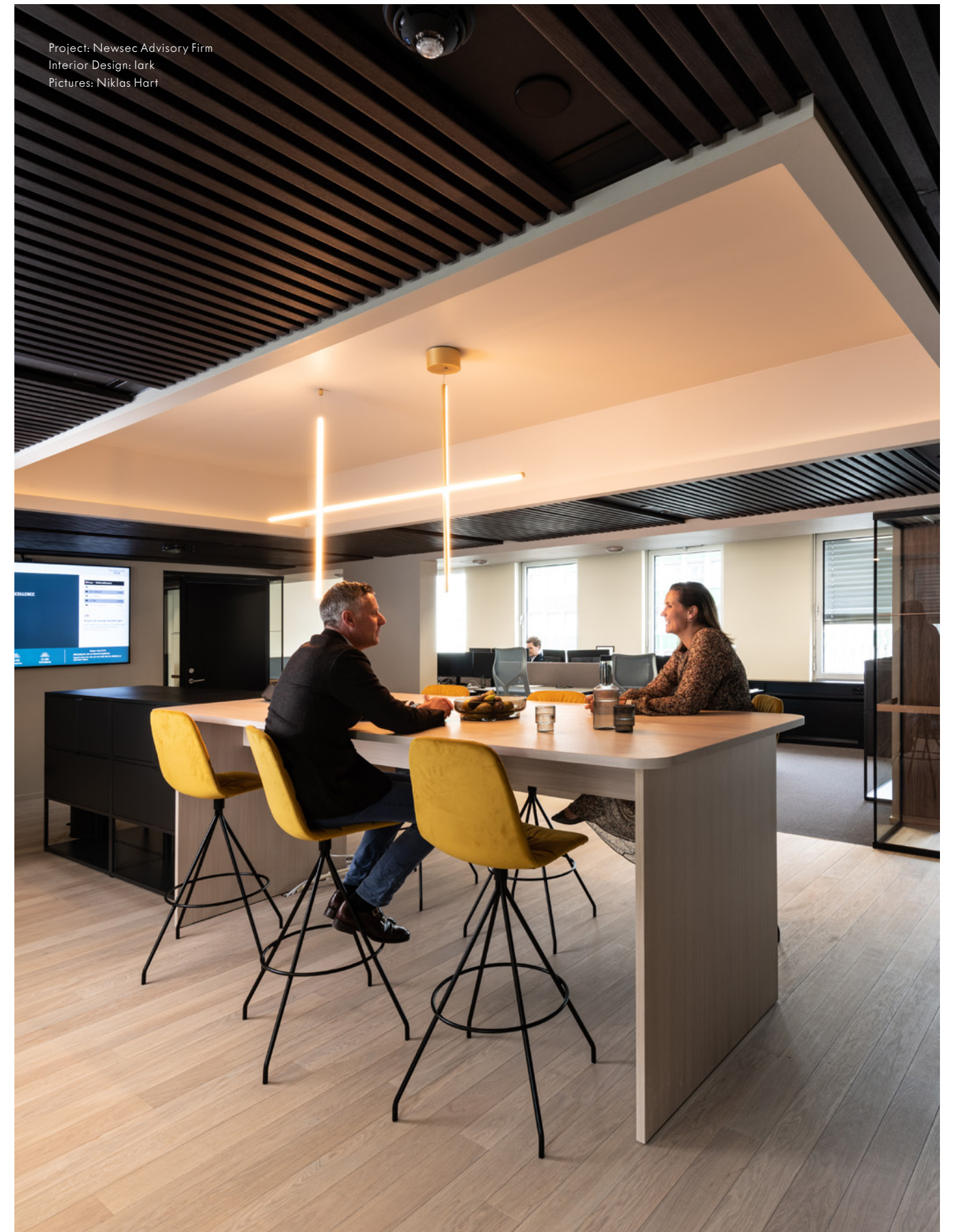

Project: Newsec Advisory Firm
Interior Design: lark
Pictures: Niklas Hart

Maarten

Lounge chair

2017 — The Maarten armchair is a perfect complement for informal meeting spaces, lounges or reception areas in large facilities. It has a slightly lower height than the chair and a wider seat, which allows for the composition of environments with other elements such as sofas, poufs and side tables. It has been proven that this lower height is ideal to foster the exchange of ideas and make users unwind whenever they need to. The comfortable armchair is also perfect for receptions as its casual and effortless style complements any room, making it appear even more inviting. In this way, Maarten Lounge will provide the necessary dose of flexibility to spaces in which one can let communication and encounter flow. As an armchair, Maarten is a particularly elegant model as regards its proportions and optional details. The generosity of its seat and the possibility of incorporating armrests with oak finishes adds a great balance to any room in the search of comfort and design.



Project: Borso Lawyer Offices
Pictures: Ángel Segura





Maarten lounge chair



Maarten lounge chair
wooden swivel base
smooth upholstery

Maarten lounge chair
swivel base smooth
upholstery & wooden arms

Maarten lounge chair
swivel base soft
upholstery

Maarten lounge chair
swivel base soft
upholstery & wooden arms

Maarten table



Maarten table H30, D120 cm
/ H11.81", D47.24"

Maarten table H30, 80x80 cm
/ H11.81", 31.50"x31.50"

Mesa Maarten H74, D160 cm
/ H29.13", D62.99"

Mesa Maarten H74, D160 cm
/ H29.13", D62.99"



Maarten table H74, D160 cm
/ H29.13", D62.99"

Maarten table H74, D120 cm
/ H29.13", D47.24" with casters

Maarten table H74, 80x80 cm
/ H29.13", 31.50"x31.50"

Maarten table H74, 160 x 80 cm
/ H29.13", 62.99"x31.50"



Maarten table H74, D120 cm
/ H29.13", D47.24" with casters

Maarten table H74, 180x80 cm
/ H29.13", 70.87"x31.50"

Maarten table H74, 160x80 cm
/ H29.13", 62.99"x31.50" with casters

Maarten table H74, 200x80 cm
/ H29.13", 78.74"x31.50" & modesty screen

Maarten chair



Maarten chair 4 legs
soft upholstery

Maarten chair sled base
soft upholstery

Maarten chair swivel
base soft upholstery

Maarten chair swivel
base soft upholstery & arms

Maarten chair swivel
wooden base soft uph. & arms



Maarten chair flat swivel
base smooth upholstery

Maarten chair 4 wooden
base soft upholstery

Maarten chair pyramid swivel
base soft upholstery

Maarten chair pyramid swivel
base with casters smooth
upholstery

Maarten chair pyramid
swivel base with casters soft
upholstery

Maarten stool



Maarten swivel bar stool,
soft upholstery

Maarten swivel bar stool,
smooth upholstery

Maarten bar stool
4 wooden legs, soft upholstery

Maarten bar stool
sled base, soft upholstery

Maarten swivel bar stool,
soft upholstery



Maarten swivel counter
stool, soft upholstery

Maarten swivel counter stool,
smooth upholstery & arms

Maarten counter stool
4 wooden legs, soft upholstery

Maarten counter stool
sled base, smooth upholstery

Maarten swivel counter stool,
smooth upholstery

FUNDA

Circular design

Collection designed by Stefan Diez, 2020



The commitment to maximum sustainability and comfort shapes Funda, a new range of seats conceived by the outstanding designer Stefan Diez.

The chair, the armchair and the stool of this new collection are presented as a construction made up of two differentiated pieces, two pieces capable of extending the life cycle of the product indefinitely. The development of Funda has been based on combining a metal structure designed to last over time, and an upholstered seat that can be replaced after years of use or severe

wear and tear. This intelligent system also facilitates the independent recycling of each of the materials in the collection.

Funda represents the balance between precision and the human-centered approach of Stefan Diez. His constant search for both industrial innovation and visual appeal has achieved in this collection a curved and friendly shape, combined with an upholstery known for its wrinkles.

In this way, Funda manages to evoke the maximum expression of comfort and makes available the different pieces.

On the left page, a picture of black naked structures in with a Funda chair. On this page, detail of the chair's leather wrinkles



THE FAMILY

The commitment to maximum sustainability and comfort shapes Funda, a new range of seats conceived by the outstanding designer Stefan Diez.



Funda family composed of a chair, a lounge chair and stools with bar and counter height in black and white structures



In these pages, pictures of a Trestle in matt oak with Funda chairs, black structure



Maximum commitment to circular pieces

Both of its parts - structure and technical cover - can be recycled independently, extending its lifecycle and fostering circular economy. With Funda we optimize resources, without compromising on comfort, durability or resistance.

Featuring Funda chair with white structure
and Serra low table in white finish



Funda

Lounge chair

Funda lounge chair is versatile, elegant, and comfortable. The piece boasts the delicate and synthetic charm the German designer brings to all his creations. Funda means “cover” in Spanish and is portrayed as a structure made up of two distinguished upholstered sections that, due to its shape, simulate the gesture of two hands embracing the user. “Funda: sustainability and comfort designed to stand the test of time.”

“Funda means “cover” in Spanish and is portrayed as a structure made up of two distinguished upholstered sections that, due to its shape, simulate the gesture of two hands embracing the user.”

Picture with Funda lounge chairs with black structure and Trino low tables



Funda Stool

“A new array of seats envisioned by the exceptional designer Stefan Diez, the new Funda collection is formulated upon the premises of sustainability and comfort.”



Picture of Funda bar stools with black structure

Shapping Funda

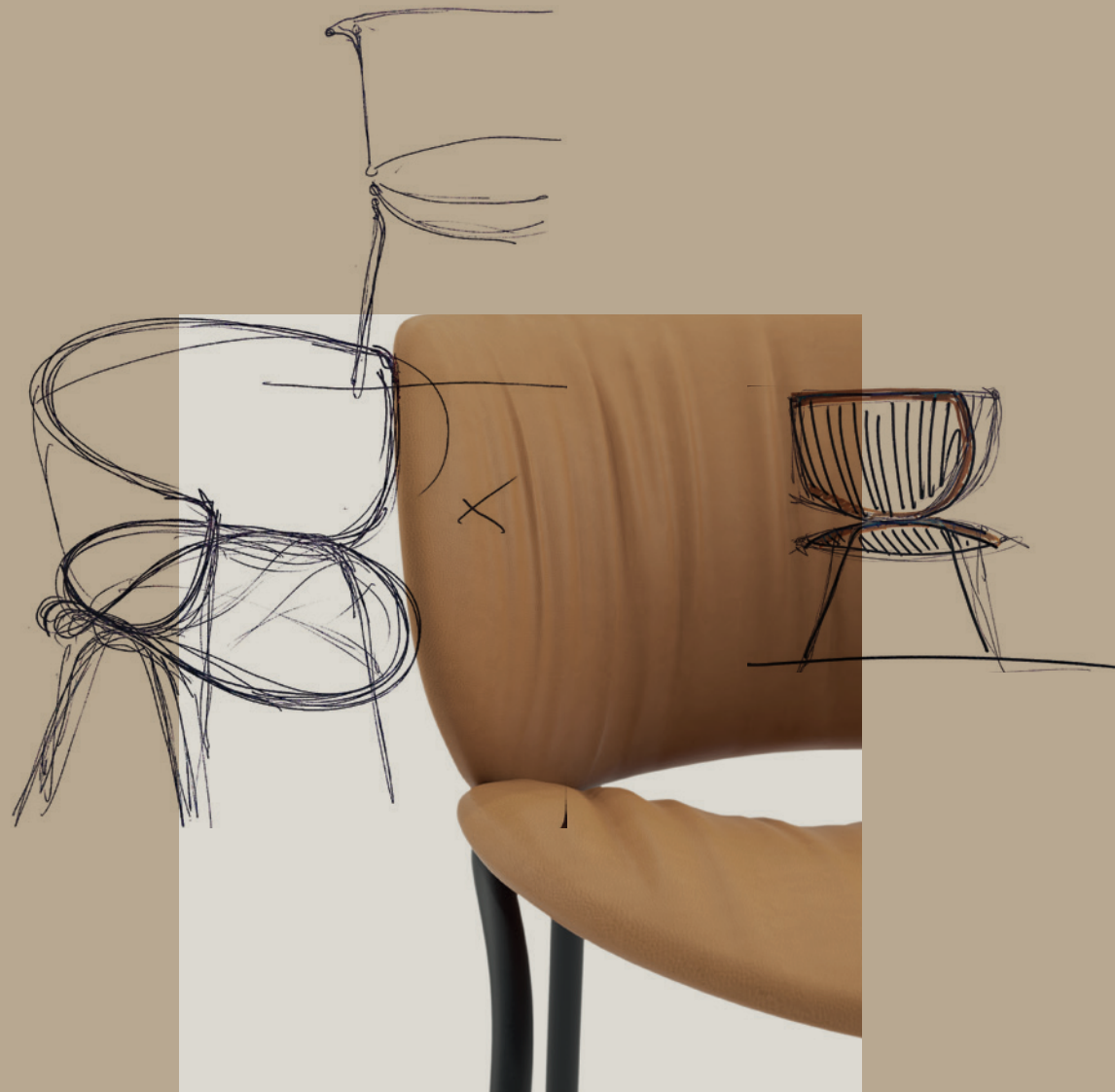

The cover symbolizes the balance between precision and the human-centered approach of Stefan Diez. His constant search for both industrial innovation and visual appeal has attained a delightful collection known for its curved and pleasing shape, and its distinctive wrinkled upholstery.

Thanks to an interior technical textile, with Funda we simplify the usual components of a chair (structure, seat and fabrics) to structure and upholstery, without compromising on resistance and comfort.

On this page, Funda chair detail and sketches by the designer Stefan Diez



On this page, pictures of the Stefan Diez's work in process at his studio. Photography: Stefan Diez Studio





Funda & Home

Home — Our lifestyle speaks about our experiences and moments, determining the space around us and how we live in it. In residential projects, a simple detail such as a chair with a kind design, and a soothing, conscious and sustainable approach as per Stefan Diez's collection will make people feel more at ease at home, transforming this space into their secure oasis where nothing could go wrong.



Funda chair



Funda chair
4 metal legs

Funda lounge chair



Funda armchair
4 metal legs

Funda stool



Funda bar stool
metal legs



Funda counter stool
metal legs

KLIP

Back to basics

Collection designed by Victor Carrasco, 2014

“The Klip family has become the great ally of educational spaces around the world, from large orchestra rehearsal rooms to library reading areas”

Certain pieces will not claim their place on the Olympus of design. Not because they are less valid, nor because their function is forgotten. It is for having the ability to let things happen in a constant and sustained way in time. We are talking about the beautiful art of facilitating, of letting a person carry out their tasks without interruption with comfort and concentration.

The Klip family has become the great ally of educational spaces around the world, from large orchestra rehearsal rooms to library reading areas. But the list goes on: desks, areas for workshops, auditoriums, classes, collaborative areas, theatres, spaces in between... It knows no limits as a seat.

Nor will we find any frontiers in their finishes: both the chair and the stool have evolved in recent years, with the intelligence of the listener. The intelligence of whom, instead of imposing, adapts to the needs that the projects themselves have demanded of them. As we discovered in the first issue of our Mediterranean Magazine, Klip was born as a commission from Tokyo Polytechnic University to Victor Carrasco.

Over the years we have discovered that it has been precisely the umbrella of this same philosophy (that of understanding what the most functional spaces require) that has prevailed in the new additions to the family.

On this page, a picture of Trestle table lacquered in white with Klip chairs in matt oak seat and swivel base



KNOWING HOW TO GROW

The new additions to the Klip family have been based simply on understanding what is needed in spaces where functionality prevails. You can choose from 7 different bases and 7 different seats for the chair, as well as combine them perfectly with each other (also with and without arms). In addition, the stool is available in a swivel version and incorporates as a novelty a fixed four-legged metal base.



Klip collection in various finishes and legs

Multiple options to foster collaboration



On this page, a picture of Klip chair pyramid base with soft upholstered. On the right page, a picture of Klip chairs swivel base with casters and lines upholstered

In both office and home environments, the upholstered version of the chair will make it easier to work for long periods of time.



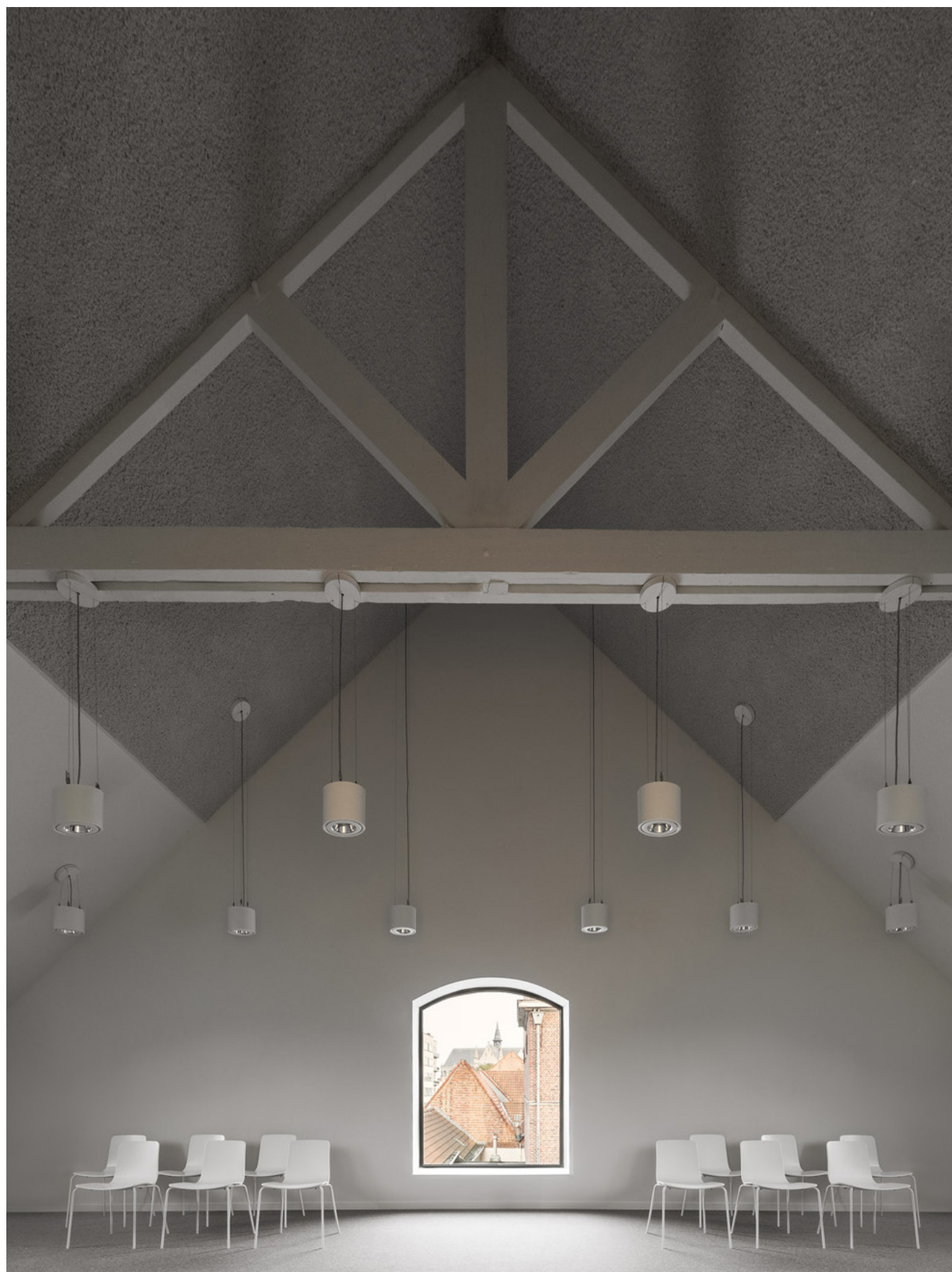

Project on the right: Hotel Canopy by Hilton, Madrid
Interiors: Jaime Beriestain Studio

Below a Klip chair with swivel base and soft upholstery





Project on the right: Turqueta Restaurant
By Tarruella Trenchs Studio

Project on the left: Ricard Camarena
Restaurant, Valencia





Project: Tate Modern, Liverpool. By Architectural Emporium & Sir Peter Blake.



Project: Hub, Middle East. Ghazi Al Sousei.
Pictures: Bashayer



Klip Stool



"Klip knows no limits as a seat. The counter height stool complements conventional work areas. It is a perfect solution for the so-called "in-between" spaces, creative environments, quick and informal meetings or areas dedicated to project development."

Klip stool



Klip bar stool Klip bar stool smooth upholstery Klip bar stool lines upholstery & arms Klip bar stool with cushion Klip bar stool lines upholstery & arms



Klip counter stool Klip counter stool soft upholstery Klip counter stool smooth upholstery Klip counter stool with cushion & handle Klip counter stool lines upholstery



Klip bar stool 4 metal legs Klip bar stool 4 metal legs soft upholstery Klip bar stool 4 metal legs smooth upholstery Klip counter stool 4 metal legs with cushion & handle Klip counter stool 4 metal legs lines upholstery

Klip chair



Klip 4 legs base table arm Klip 4 legs base with handle Klip 4 legs base with cushion Klip 4 legs base soft upholstery & arms Klip 4 legs base lines upholstery



Klip pyramid swivel base Klip pyramid swivel base with handle Klip pyramid swivel base with cushion Klip swivel base soft upholstery Klip swivel base smooth upholstery



Klip swivel flat base Klip swivel flat base with handle Klip swivel flat base with cushion Klip swivel pyramid base with casters Klip swivel pyramid base with casters & handle



Klip swivel pyramid base with casters Klip five casters base lines upholstery Klip five casters base lines upholstery & arms Klip five casters base

QUADRA

Lightness & comfort

Designed by Mario Ferrarini, 2019



The Quadra collection was not designed in a day. No good design appears by chance. Perhaps the idea does, but then it is a matter of making it a piece of art. From the very first moment, this chair has been able to inspire love at first sight. Because almost without knowing it, it was born an icon. It took shape in an exercise of drawing on paper, with the same skill as an architect's sketch, with the same language and proportions.

Quadra emerged from a very light structure visually, but

fully capable of resisting the passage of time with firmness, being perfectly prepared to be placed in all types of spaces and projects. In the words of Mario Ferrarini.

"I was interested in approaching the Viccarbe team by working on the concept of a chair that is both minimalist and surprising. A chair that, in essence, could escape the standards of a product category that is extremely saturated with proposals. Becoming a recognizable piece beyond its use and functionality."



Featuring Quadra chair in matt oak and ash finish

On these pages, Quadra chair
in stackable version



Quadra has the
possibility of stacking
10 units in a completely
vertical position

One of the most surprising aspects of the chair is the possibility of stacking 10 units in a completely vertical position. Turning a 100% functional feature into a real standout point.



ESSENTIAL LINES

Quadra has continued the journey of the Viccarbe collection in recent years: being able to perfectly balance simplicity with durability, versatility with the personality of the great icons.

“The chair is inspired by a dance of two figures, turning in complete harmony, in dialogue, embracing. A ‘pas de deux’ between a technical, metal, functional, slim structural core, and the warmth of wood. Dressed differently, the two bodies display a sense of alchemy from every angle. Just like the compass of the architect and the paper on which he draws.”



In these pages, a picture of Trestle table lacquered in white with Quadra chair full white

Quadra evolves and offers the possibility of incorporating upholstered cushions. It provides greater user comfort while maintaining the chair's iconic shape.



Choose Quadra
with cushion for an
upgrade in comfort

On this page, Quadra chair, black structure, matt oak seat and cushion. Quadra chair black structure, matt oak seat and seat cushion.



Quadra & Mix

Collaborative spaces — From the very first moment, Quadra has been able to inspire love at first sight. The chair is a convenient option for projects that require excellent functionality and durability, and can additionally be stacked in large quantities, saving space where required.



On the left page, a set of Maarten table and Quadra chairs in ash. On this same page, Quadra chair with black structure and matt oak seat with Eli tables. On the right, a picture of Quadra chairs



A recognizable piece beyond its use and functionality

On these pages, a set of Trestle table in matt
oak and Quadra chairs lacquered in ash.



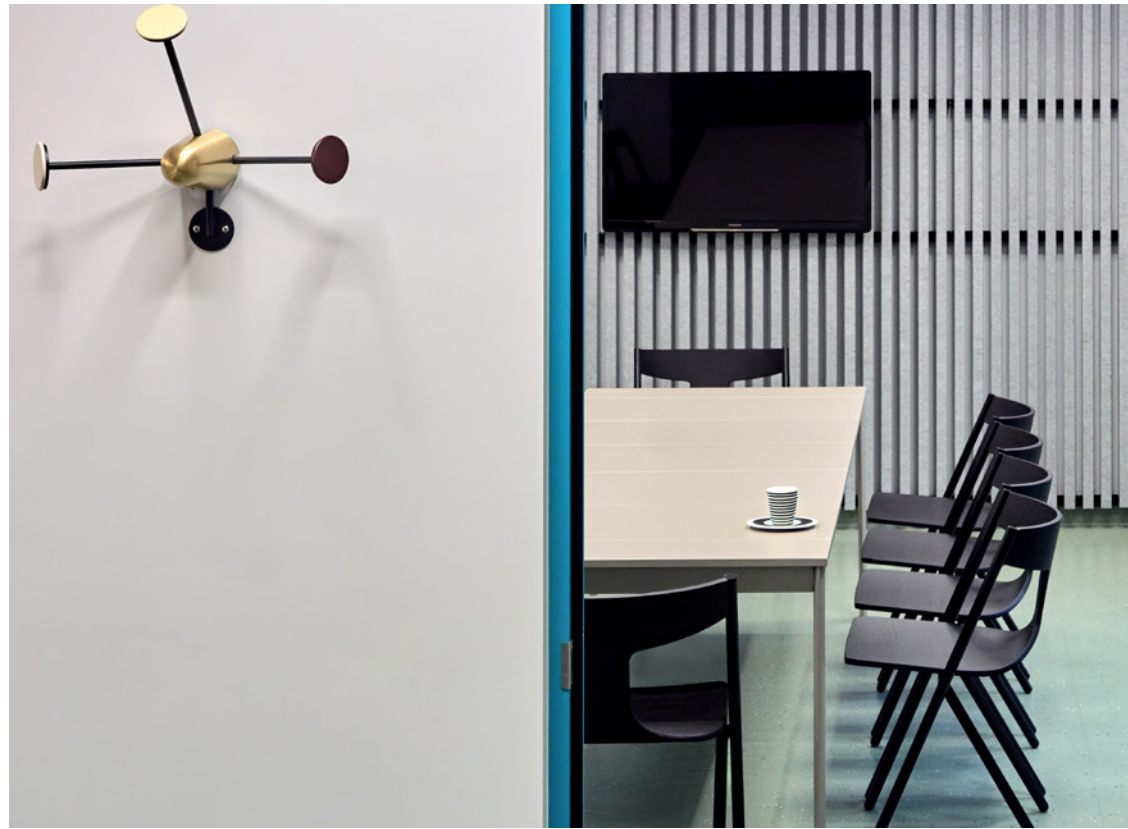

Project: Dental Clinic, Lithuania.
Design: Ruta Bagdzeviciute.
Photography: Paulius Gasiunas

On these pages, Quadra chairs with
black structure and matt oak seat







Quadra chair



Quadra chair



Quadra chair, stackable



Quadra chair, full white



Quadra chair with seat cushion



Quadra chair with seat and back cushion

ACE

The subtlety of a gesture

Armchair designed by Jean-Marie Massaud, 2007

“Today, more than ever, within the office space we are looking for small oases in which to take refuge. We want particular corners in which the “I” takes on as much relevance as possible.”

The last few months have made the concept of well-being particularly relevant. An ethereal idea, invaluable, immaterial in many cases. A minimum that allows us to face our day to day with concentration and stability.

Today, more than ever, within the office space we are looking for small oases in which to take refuge. We want particular corners in which the “I” takes on as much relevance as possible. They are places in which we simply seek to feel comfortable, safe, at certain times we may even be protected by a certain amount of privacy.

The Ace chair is one of those designs that are born with a

protective instinct, returning us to the most essential comfort. As a product, it will subtly attract our attention with a slightly wrinkled and friendly upholstery. It will welcome us and, ultimately, give us the space we need to reconnect.

In recent years, Jean Marie Massaud’s design has been incorporated into the work spaces of large multinationals such as Nike and Toyota. It was included in certain projects, as a space for informal and collaborative meetings. In other projects, it was also incorporated in an individual format: located inside private offices or rest areas, and set up as a place to go in search of a universe of one’s own. It’s time to regain a sense of well-being.

On this page, Ace armchair with wooden base and Burin Mini in black finish







Ace & Lounge

Transitional Spaces — We say goodbye to the so-called waiting areas to welcome the intermediate or transitional spaces. The essence is the same, probably even the arrangement of the furniture.



Project: VIVOOD Landscape Hotel, Alicante
Pictures: Ángel Segura



Project: Viccarbe Headquarters
Pictures: Javier Díez



On these pages, Ace armchair metal base in black with grey upholstered and red zip.



PENTA

The triumph of geometry

Armchair designed by Toan Nguyen, 2011

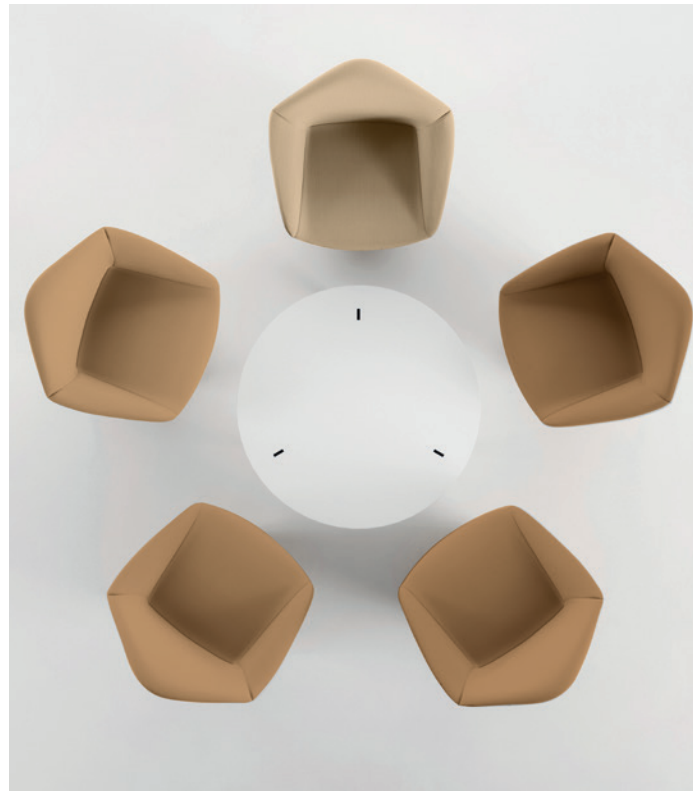

Comfort, as something universal, could be defined as the feeling that everything is in its place. For this reason, geometry usually becomes a great tool with which to speak to our audience. In the case of Penta, we sculpted an armchair with very thoughtful proportions. We designed it with Toan Nguyen's help with the sole purpose of facilitating its understanding, of generating a kind of connection

between everyone who saw it for the first time. However, there are additional factors with which we can strengthen the link, unexpected details capable of bringing a smile to anyone who ends up sitting in this chair. In a totally discreet way, Penta can incorporate a rotating base. This is an invisible detail capable of changing the attitude and interrelationship between partners in the same space.

Project on left page: Cottonella Offices, Italy.
Architecture: J+S Architecture & Engineering.
Interior Design: FASEMODUS + Studio AI Milano
Pictures: Lea Anouchinsky



In these pages featuring Penta armchair
and Burin Mini in taupe finish





Composition of Penta lounge chairs
in purple fabrics

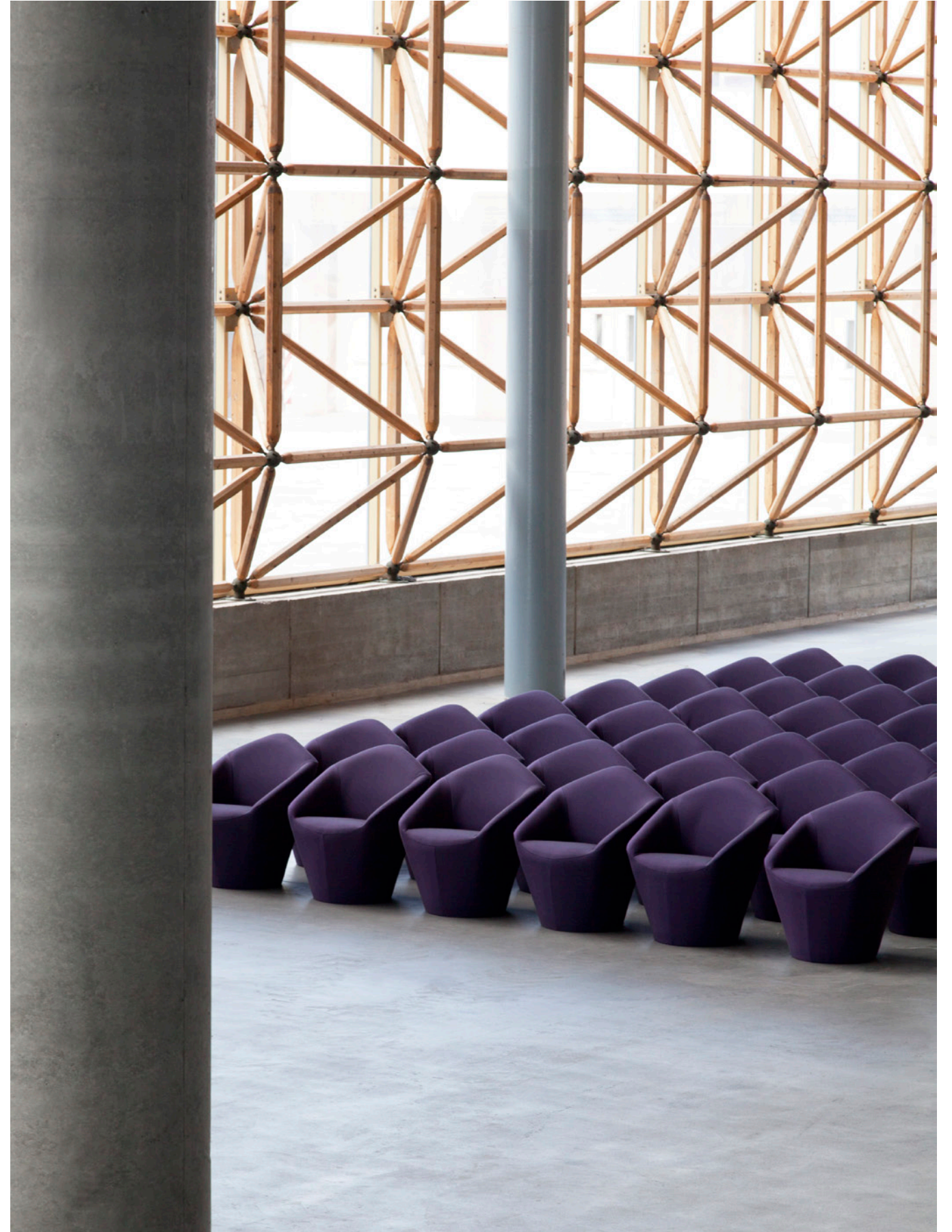



Project on the left: Teulada Moraira Concert Hall

Project on the right: Cottonella Offices, Italy.
Architecture: J+S Architecture & Engineering.
Interior Design: FASEMODUS + Studio AI Milano
Pictures: Lea Anouchinsky



On the left, featuring Penta armchair with Burin Mini. On the right Penta armchair with Tiers low table



LEVITT

Sensual and suggestive

Collection designed by L+ R Palomba, 2007

We know products that are capable of living several lives. They are pieces that come to enjoy different stages according to the finishes they are given. Levitt is one of these promising cases. Both the sofa and the family seat designed by Ludovica & Roberto Palomba enjoy extraordinary comfort. Since 2007, its sensual and suggestive design has been able to endure over time: evolving and being able to assume new upholstery. Levitt literally embraces every guest who sits on it. Its silhouette is a good-will statement, an exercise in pure ingenuity, of friendly design thought by and for people.



On this page, a picture of Levitt sofa and armchairs with Ryutaro low tables



In 2007, Ludovica and Roberto Palomba materialized the Levitt collection, portraying the best of a relaxed and contemporary Italian design. A line seeking optimum comfort for the user through a suggestive, proportional and unexpected design of modules, enabling multiple combinations. A collection with the exact dose of personality and sensorial forms that converse with anyone who sits on it. Certainly a benefit when furniture is used as part of large projects, and already a hallmark of Ludovica and Roberto Palomba's work in the Viccarbe collection.

On this page, a picture of two Levitt armchairs and Bamba low table





A suggestive proposal
to embrace everyone
who sits on it



Project: Flamingo Paradise Hotel
Architecture and Interior Design: Constanti Architects



Club Alma Sensai, (Spain)

Welcome areas — In these spaces is where we can cause the best first impression. Pieces such as Levitt look great from every angle, adding sophistication into the atmosphere.



Interior Design: Mar Vera for Welcome Design
Photography: Paloma Pacheco Turnes

On this page, a picture of two Levitt armchairs and Giro low table with brass structure and matt oak table oak.

With the aim of being as versatile as the user requires, Levitt sofa offers the possibility of adding modules to tailor any specific needs spaces might require.

A modular sofa without stridency, with the exact dose of personality and with fluid forms that converse with everyone who sits in them.



Levitt sofa



Levitt sofa, 152



Levitt sofa, 184



Levitt sofa, 244



Levitt chaise



Levitt sofa, composition L1

Levitt armchair



Levitt armchair

SEASON

Unexpected details

Collection designed by Piero Lissoni, 2011



Designed by Piero Lissoni, the Season collection represents the balance between simplicity and a carefully thought design.

We know that clear and defined forms penetrate the mind faster and longer. This is where we find the real reason for the existence of contemporary design. The modular parts make the work of the interior designer easier. This is so because there is

nothing like having total freedom when it comes to creating a space. There is nothing like playing with the silhouette of different objects, like creating relaxed and flexible environments in which to promote collaboration. Each and every element that makes up the Season family has been born from surprising and unexpected details.

“The modular parts make the work of the interior designer easier. This is so because there is nothing like having total freedom when it comes to creating a space. There is nothing like playing with the silhouette of different objects, like creating relaxed and flexible environments in which to promote collaboration.”



Picture on this page, overhead view of different configurations of Season Sofa with Season Puffs and Trino low tables

Season *Chair*

2015 — Any pleasant or unpleasant sensation the human being feels prevents him from concentrating on what he has to do. Lighting, temperature, noise, table height, chair comfort... all these ingredients are part of the equation. A person who is not comfortable in a space will be thinking about the causes of this discomfort rather than the task at hand. The ideal executive office today is a daytime living room, where work can be done under less stress and no distraction.



With hidden casters
Pure balance and dynamism

On this page, Trestle in white with Season chairs with casters



The ideal executive office today is a daytime living room



Project below: Newsec Advisory Firm
Interior Design: lark
Photography: Niklas Hart





Season Chair & Work

Office — Season's unusual caster system adds dynamism to spaces. Its sinuous silhouette brings great warmth to both contract and residential projects.



Project: Generali Offices, Italy
Interior Design: mpengeering
Agency: Entis. Pictures: Lea Anouchinsky

Unique chair with a
geometric shape designed
by Piero Lissoni



Season *Sofa*

2017 — Halfway between rationalism and sensuality, the Season sofa is in line with the rest of the collection designed by Piero Lissoni. It is composed of two rounded volumes: a cube and a vertical rectangular piece, capable of generating a suggestive geometric play.

It offers 3 different versions that can be perfectly combined with each other and in a totally intuitive way: the modules can be straight, open or closed. In addition, just like the chair in the collection, it includes a washable technical fabric protection for the area that is most exposed to the footwear. Is there a better offer?

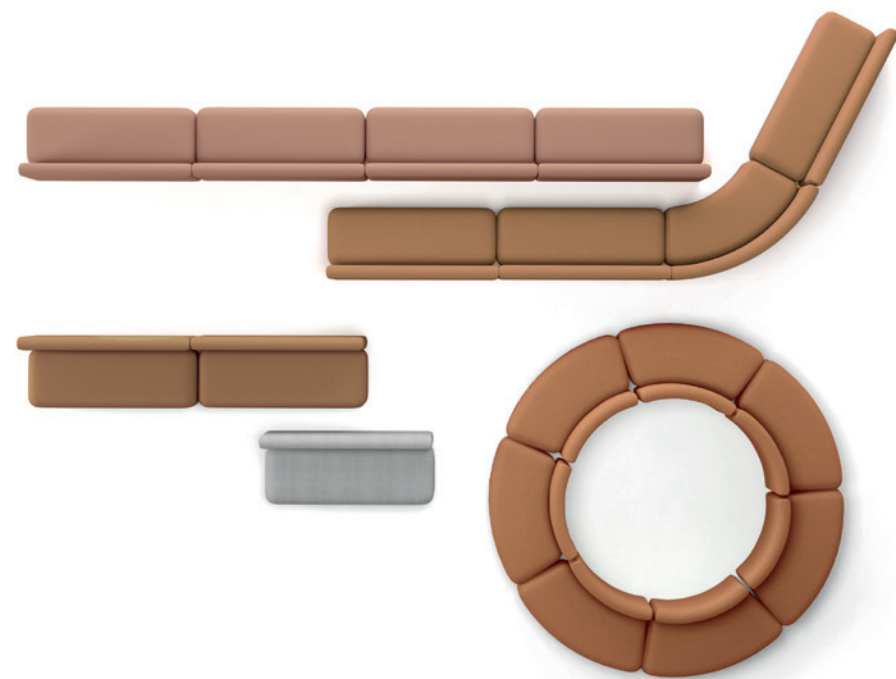

Project: Clínica Alenjandría, Valencia
Interiors: Erre Arquitectura
Project: AT4 Grupo
Photography: Javier Diez

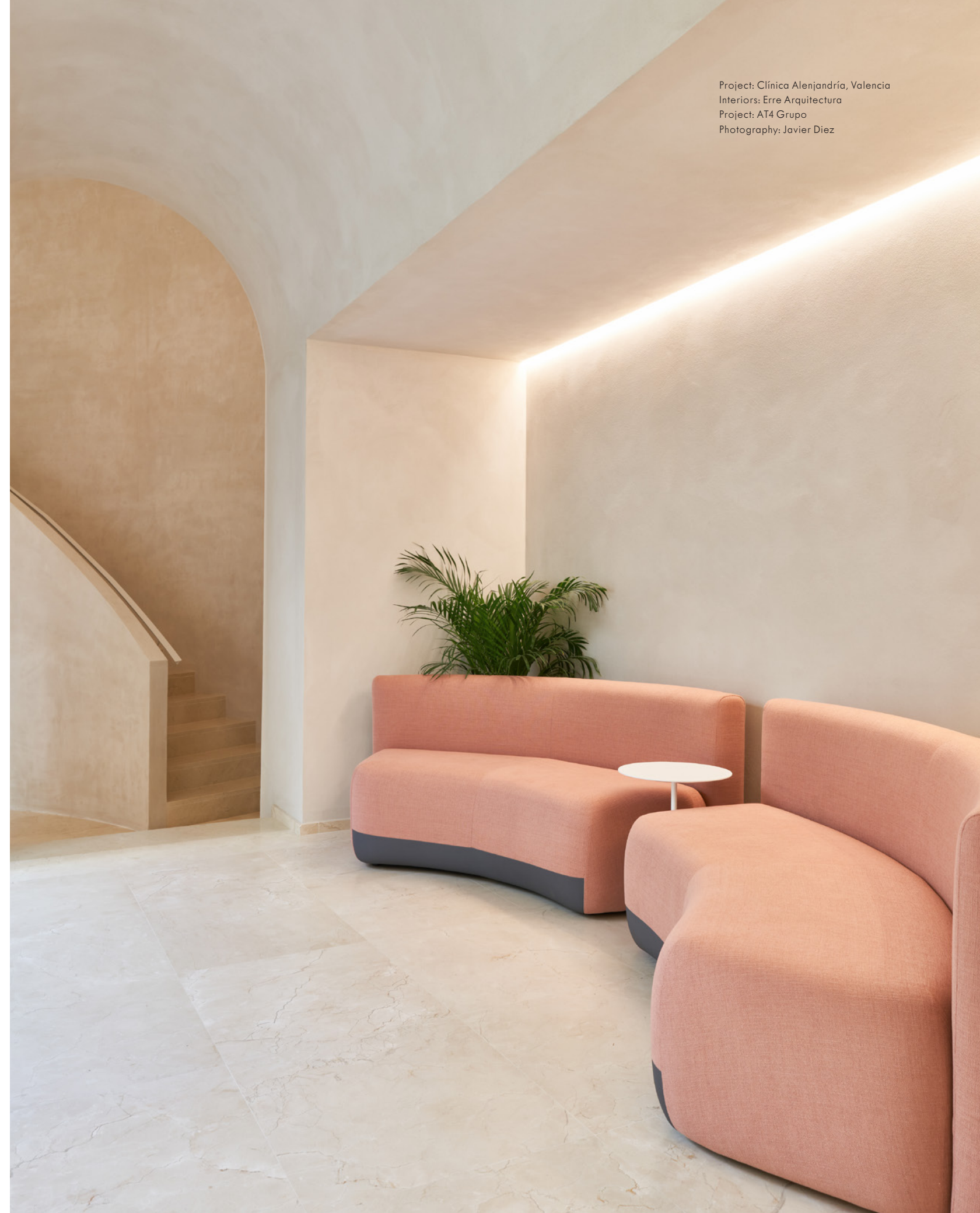

On these pages a composition of Season sofa, Burin Mini, Season Pouf, Season chair and Ace armchair





Pictures on the left & right page: closed Season Sofa. Straight, closed & open Season Sofa

The pieces express the
act of sitting through a
very simple approach



Pictures on the left & right page: closed Season
Sofa. Straight, closed & open Season Sofa.





The three modules of the Season sofa allow the creation of different compositions, giving more value to the lounge experience concept created in 2017.

With Season, you can configure disruptive compositions with its 3 different modules, especially practical to design kind waiting zones, lounging spots and reception halls. The protection band located at foot height is optional, but very useful to

extend its lifecycle in areas with severe traffic such as restaurants or airports. Get inspired with our established configurations, but you can play and design as many different layouts as you require.

Season sofa



Season sofa, Composition 1



Season sofa, Composition 2



Season sofa, Composition 3



Season sofa, Composition 4



Season sofa, Composition 5



Season sofa, Composition 6



Season sofa, Composition 7



Season sofa, Composition 8



Connectivity



1. Power socket, upholstered

SEASON BENCH

2011 — With the Season bench, designer Piero Lissoni was able to evoke the posture of a relaxed person as elegantly as possible. Simulating a sculptural and emphatic piece, its force gives the user all the freedom of a bench that does not impose, but suggests. It was born in its day as a novel product category that —thanks to the upholstery and its sinuous silhouette— would bring greater warmth and kindness to contract projects.

Its streamlined proportions, singular shape with two heights allowing different seating positions, make this bench a very valuable piece of furniture.

“Simulating a sculptural and emphatic piece, its force gives the user all the freedom of a bench that does not impose, but suggests.”

In these pages, picture of Season Bench and Burin Mini





On the left, Season bench.

Project on the right: Teulada-Moraira Music Hall, Spain. By Francisco Mangado.
Photography: Ángel Segura.

Its force gives the
user all the freedom
of a bench that does
not impose, but
suggests



Season *Pouf*

2014 — The successful collection signed by Lissoni grows with poufs of new dimensions. The family members keep the option of including its intelligent system of hidden casters, very suitable for office and educational spaces where agility and dynamism prevail. As a true game of geometric shapes, this extension of the collection covers all the needs that may arise within the intermediate spaces and collaborative areas. In short, Season has become a particularly adaptable, flexible, friendly and attractive design, thanks to its sensual shapes.



On this page, picture of Stan table in black and Season Poufs 40 | 23 without strap

On these pages the Season Pouf collection
and Serra low tables in different finishes

Additional seating
with hidden casters
to add dynamism into
collaborative spaces





On this page, a picture Season Pouf 50 | 19^{11/16} and 60 | 26^{5/8} with along with black strap and Eli low table.
Below, picture of Serra low table with Season Pouf 50 without strap



On this page, a picture of Season Poufs 40 | 15^{3/4} with black strap





Project: Barrow advertising.
Interior design: Ghislaine Viñas

STEP

Modular minimalism

Sofa designed by Vincent van Duysen, 2013

"Step is composed of a large island of modular elements, available in a variety of colors that offer the possibility to create countless compositions to fit in any space."

Exquisite proportions, infinite compositions, and surprising comfort define Step, a modular sofa designed by the renowned architect Vincent Van Duysen. Handcrafted seams give warmth to this unique collection which is pure functionality and adaptability. Conceived in 2013, Step is the result of a deep analysis of monolithic forms related to the cubist style movement. Cubist elements play a prominent role in the concept, and through its rationalization, a clean design is established and the strong contours are enhanced by its distinctive stitching detail. Step is composed of a large island of modular elements, available in a variety of colors that offer the possibility to create countless compositions to fit in any space.

Finding the balance between durability and comfort, the Step collection was born as a modular system with which the user could compose and create his own sofa based on Van Duysen's various proposals.



Cubist elements play
a prominent role in
the concept

Project on the right: Private residence, Toronto

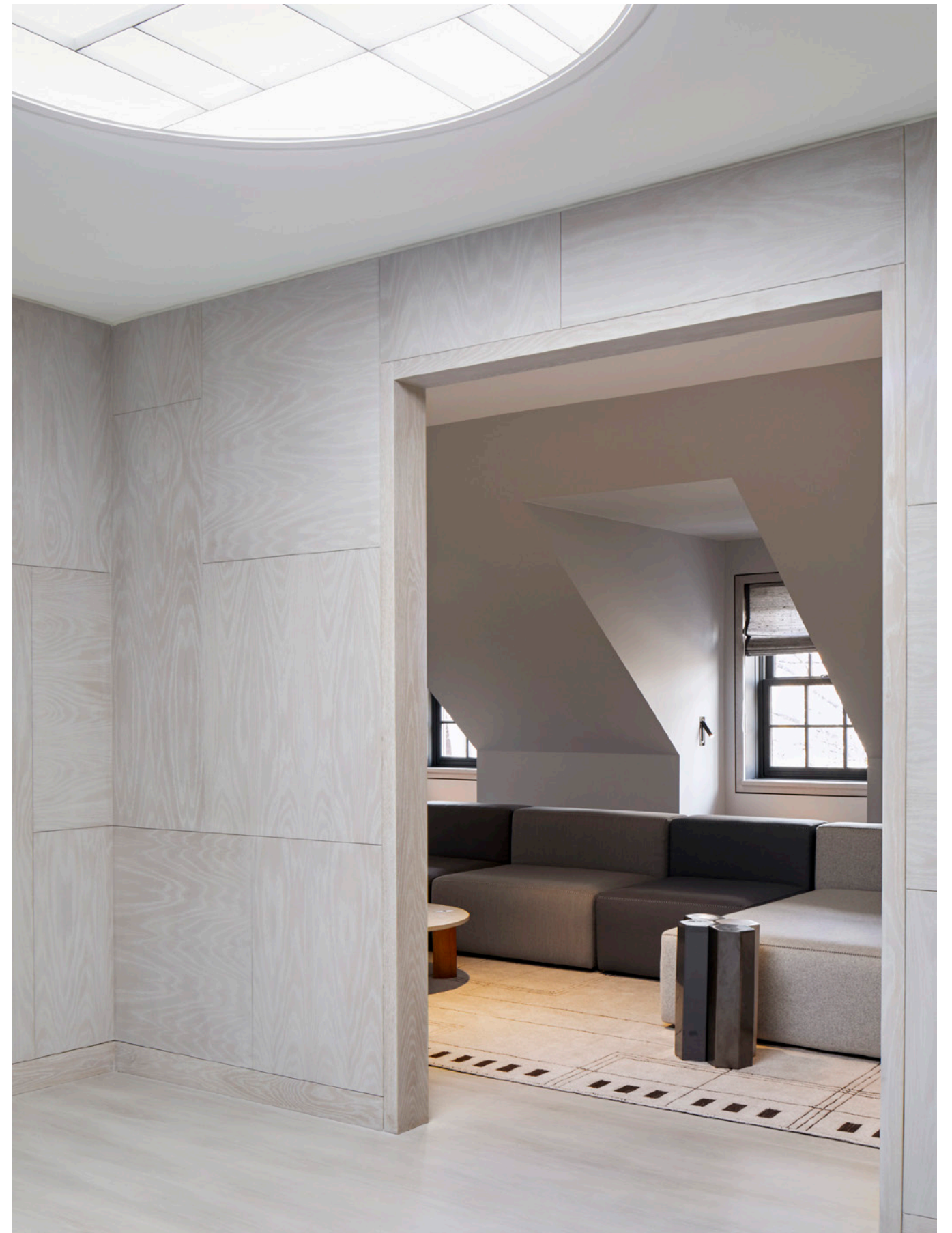



On these pages, a picture of Step sofa with Serra low table

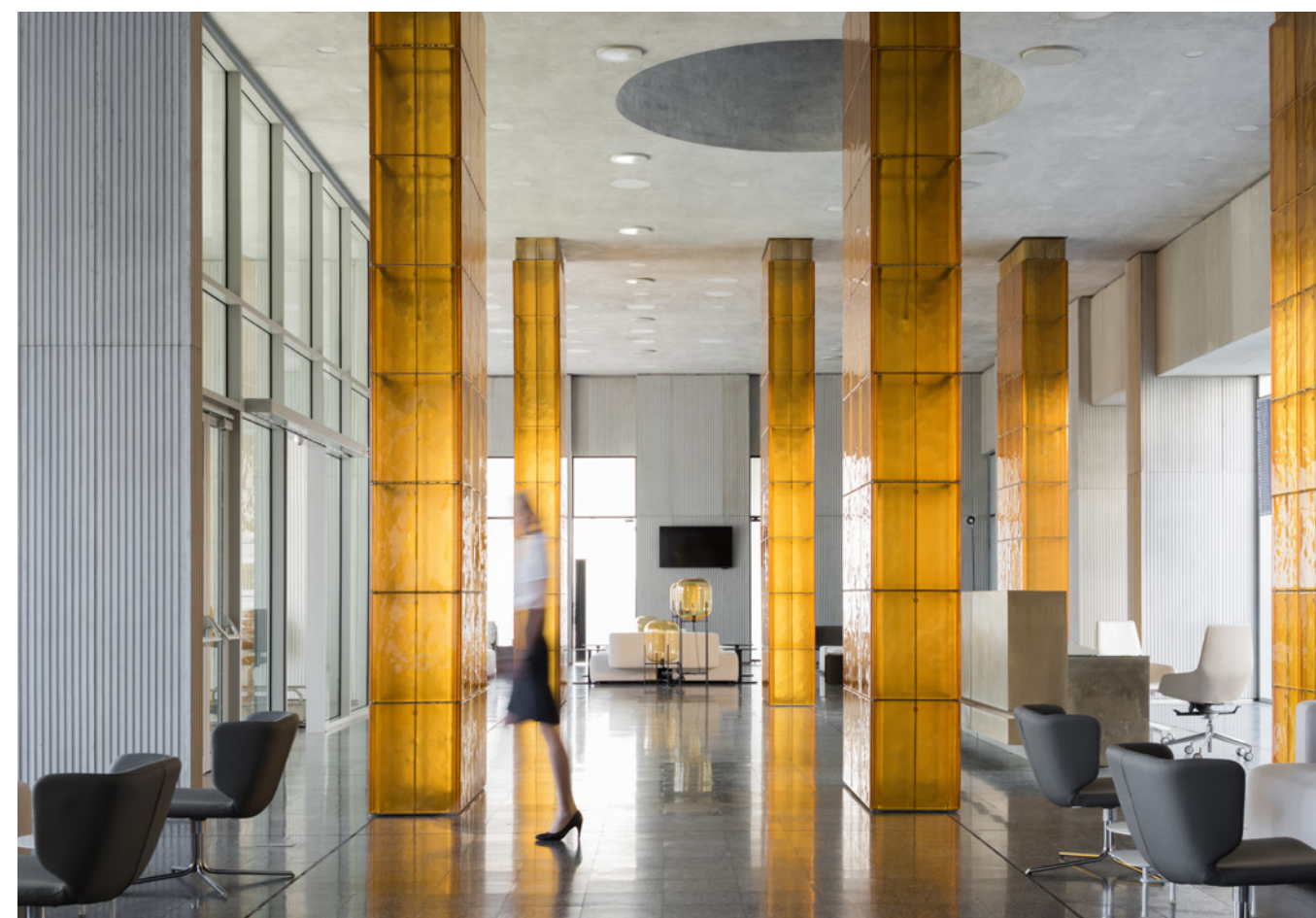



Project: VIVOOD Landscape Hotel, Alicante
Pictures: Ángel Segura



Project: The Ovolo Woolloomollo Hotel
Interior design: HASSELL
Pictures: Nicole England

Project on the left: Takasaki Theater.
Pictures: Nacása & Partners Inc.
Special thanks: Interiors Inc.

Project on the right: Farmacias del Ahorro.
Pictures: Daniel Sánchez Castillo





Step sofa



Step sofa, Composition 1



Step sofa, Composition 2



Step sofa, Composition 3



Step sofa, Composition 4



Step sofa, Composition 5



Step sofa, Composition 6



Step sofa, Composition 7



Step sofa, Composition 8

Step armchair



Step armchair, narrow arm



Step armchair, wide arm

NAGI

Extraordinary hospitality

Armchair by Tomoya Tabuchi, 2015

Nagi was born swinging between the present and the future. Wishing to define the future from calm and reflection, moving away from emergencies and focusing on what is really important.

Designed by Tomoya Tabuchi with soft and rounded forms, the armchair arrived with the humble precept of making public and private spaces more pleasant. In order to become a reference point to which you can always go within a space. In 2015, it was incorporated into the Viccarbe collection keeping in mind the people who needed to take a break, either in its high or low back version, in its fixed version, or in its modern rocking chair, letting its silhouette simply pick them up.



On this page, a picture of four Nagis with smooth upholstery and white rocking base and two shapes: model O and model H

On this page, Nagi Low armchair with soft upholstery and fixed base in black with an Up in the Air low table in white finish



We find a special connection between Japanese and Mediterranean design



Nagi is like those places where you feel like staying because you have been treated with extraordinary hospitality.

With a particularly contemporary character, as disruptive as it is pleasant in its packaging, it has managed to fit perfectly into the collection. This is an arduous task when it comes to modernization because just as with comfort, innovation is a sine qua non value for the furniture industry, a basic aspect that is taken for granted from the moment you start creating a piece. However, putting too much pressure on the accelerator

can sometimes result in something that is far from reality. This is how Nagi was born, grew and materialized: thinking about renewing the concept of the traditional rocking chair. Looking ahead, no hurry but no pause, as they say.

It is here that we find a special connection between Japanese and Mediterranean design. Both are unpretentious and specialists in relying on tradition to bring it up to date, thinking of new attitudes to create long, pleasant, proportionate and humanistic designs.



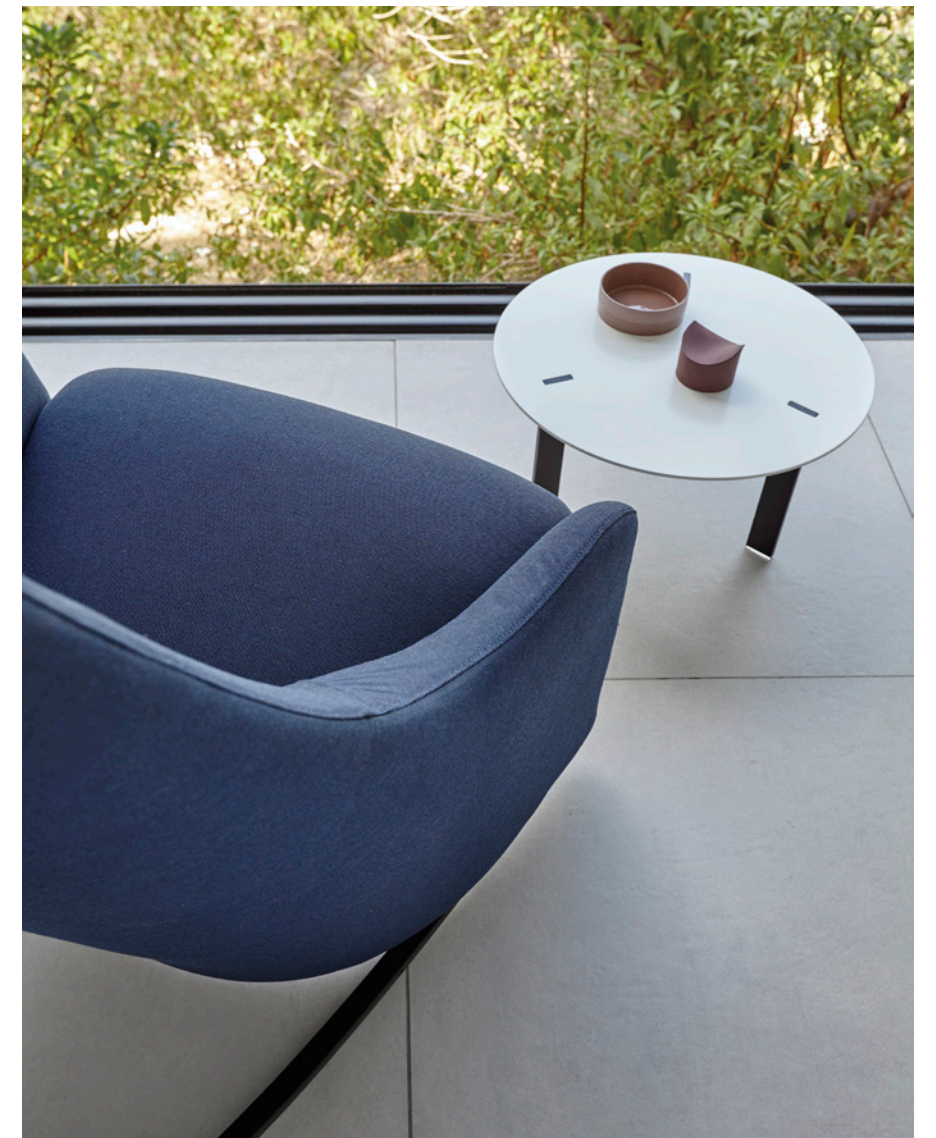



Project: KPMG Toronto North

LAST MINUTE

The elixir of eternal youth

Designed by Patricia Urquiola, 2006



The Last Minute stool was conceived with materials of great resistance and durability, under an umbrella of sustainability that would intuitively mark the minimums we are looking for today in Viccarbe when creating a new product.

Above all, we believe that industrial design should understand sustainability as an inherent value in new creation. In this case, the Last Minute stool was born with the soul of an icon, with the spirit of an eternal object. Its idea of contemporary design (timeless and enduring over time) allows us in the long run to avoid using natural resources in an unnecessary way.

We also believe that the pursuit of innovation is not only important when designing new products, but also when replacing specific parts of a piece of furniture. In the case of this model, it is possible to replace the seat if the passage of time has worn it out excessively.

Another of the most positive aspects when referring to the concept of sustainability is its seat in rotomolded polyethylene. We consider this 100% recyclable component to be an intelligent ingredient that has allowed us to delve into the idea of democratic, affordable and long-lasting furniture. Its lightness, ease of





cleaning and resistance to environmental agents such as natural light or changes in temperature are just some of the benefits that have led it to and maintained it in various work spaces.

In any case, when creating a new product, it is important that we reflect on each and every one of its elements. Textiles matter too. The upholstered version of the stool was to be added to the collection years later. Because the conversation should not end with plastic or wood, it is important to note that we have decided to incorporate a selection of fabrics in tariff 100% manufactured with recycled materials (such as polyester, wool or nylon).



On the right page, a picture of two Last Minute stools with structures in taupe and upholstered seats

Last Minute & Food

Home Areas — Exquisite kitchens and hospitality spaces around the world have included the Last Minute stool as part of the equation.



Project on the right: TPC Residence, Melbourne
Interior Design: MIM Design
Pictures: Sharyn Cairns

Project below: Marisa Ho's Kitchen, Melbourne



... & Work

Office — Within the workspace, Last Minute has become a clear winner in the battle for comfort. Its lightness, easy cleaning and comfort have contributed to the presence of the stool in office environments.

Project above: K2LD Melbourne
Pictures: Jeremy Wright

Project on right: ERRE Arquitectos Offices, Valencia
Interior Design: ERRE Arquitectos
Pictures: David Frutos



Standard tables

Discover 2 different tables for your next hospitality spaces. The versions of Stan and Eli with HPL and compact core boards will become pieces of furniture resistant to constant sanitization.



VICCARBE STUDIO, 2015

Stan

Like Eli, the Stan collection is characterized by the multiple sizes, finishes and shapes of its lids.



On this page, a picture of Stan table full white with square table top with a Copa chair, cantilever base and a Torii bench

STUDIO VCCB, 2015

Eli

The lightness of its aluminum base, and the different size options, make this table a perfect element for restaurants.



In these pages, a picture of a coffee area with Eli tables in black and Maarten Plastic chairs, sled base

On this page, a picture of Stan table full white with Klip chairs



BRIX

Geometric comfort

Armchair by Kensaku Oshiro, 2013

“With the Brix armchair, we manage to synthesize in a single piece the function of a seat and an auxiliary table. Along with designer Kensaku Oshiro, we satisfied a need with simple geometric shapes of surprising comfort.”

One of Viccarbe's maxims is to inspire new ways of interacting. With the Brix armchair, we manage to synthesize in a single piece the function of a seat and an auxiliary table. Along with designer Kensaku Oshiro, we satisfied a need with simple geometric shapes of surprising comfort.

In this gradual return to the work spaces, one of the positive aspects that stand out is the search for greater concentration.

It means moving out of our comfort zone inside the home and recreating it at specific times inside the office. Collaborative spaces are simply being redefined.

In this gradual return to the work spaces, one of the positive aspects that stand out is the search for greater concentration. It means moving out of our comfort zone inside the home and recreating it at specific times inside the office.

Collaborative spaces are simply being redefined. We want

to design rooms that encourage concentration, inspire and are also a place of relaxation. We look for versatile environments that are visually stimulating and are long-lasting as well. Brix is suitable for any work environment, allowing the creation of elegant configurations in common areas thanks to its geometric design and its careful dimensions. It is an armchair of rigorous and specially studied proportions, capable of bringing together in a single piece the functions of a seat and a side table.

Hence the asymmetry of its arms: the wide part was designed as a multipurpose surface, perfect for supporting a mobile phone, a book or a tablet. It is a multi-purpose chair intended to make the user's life easier at a time when agility is a priority. Spaces are redefined to become more connected, functional, comfortable and attractive environments that facilitate people's creativity and well-being.

On this page, a picture of a Brix armchair with table lacquered in brick on the left side



Brix & Lounge

Transitional Spaces — Brix offers the possibility of including a side table, providing an extra dose of functionality and adaptability to any space.



Project on top: Mc Cann Offices, Italy
Interior Design: FASEMODUS + Studio AI Milan
Pictures: Lea Anouchinsky



Project: Teulada-Moraira Concert Hall, Alicante
Architecture: Francisco Mangado
Pictures: Ángel Segura

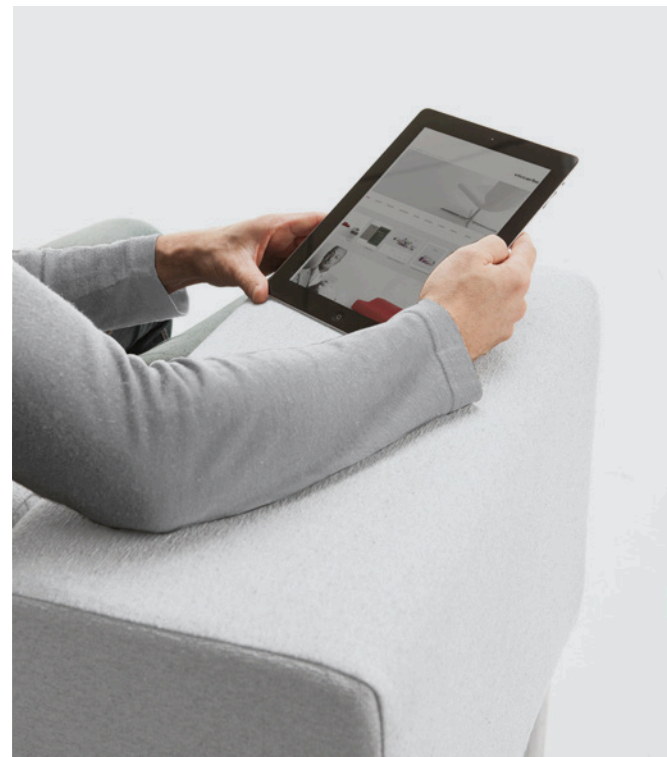

Project: Castellón Concert Hall, Spain
Pictures: Ángel Segura

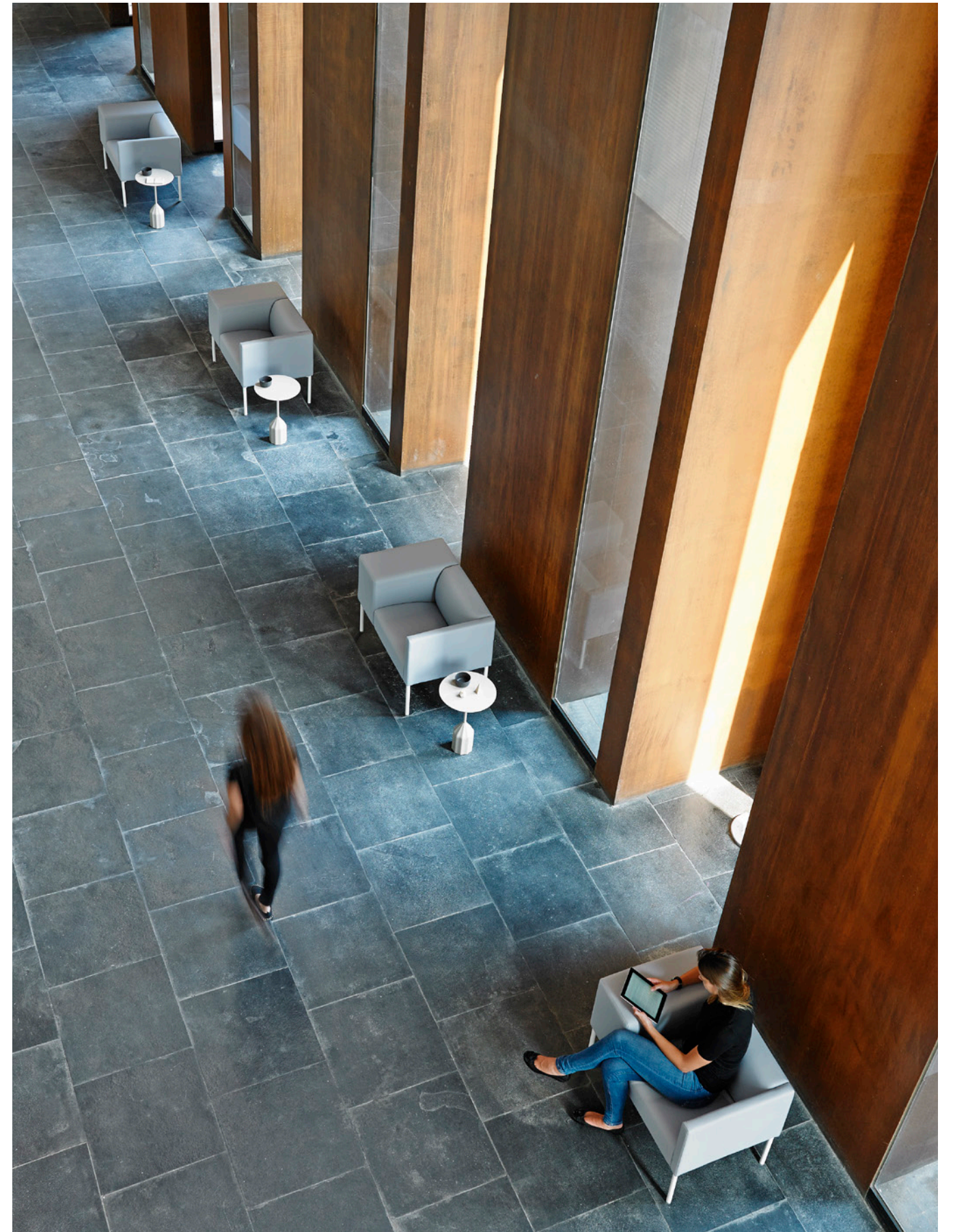

TORII

Comfort and stability

Bench designed by L + R Palomba, 2018

The timeless Torii bench was born as a simple seating system, capable of projecting a great identity. Torii is composed of two wooden pieces connected by a very recognizable metal structure. Torii stands out not only because of its front perspective, but also because of its back. In the eyes of Ludovica and Roberto Palomba, the bench's image has managed to convey the creative concept perfectly:

"Its T-shaped structure represents the gateway to Eastern temples. It's a kind of approach, an evocative inspiration..."



Its T-shaped structure
represents the gateway to
Eastern temples

Different Torii bench configurations, including
upholstered and stained options





Torii & Mix

Transitional spaces — Torii is a flexible bench able to respond to all needs as it has the same height as a chair. A very versatile seating system with clean lines and a great identity, easy to use in any location.



Up on this page, a picture of Torii full upholstered with black structure. On the right, image of Torii with seat upholstered and backrest stained in matt oak



Up on this page, a picture of Torii with cushions and black structure. On the left, picture of the same model at a coffee area

Up on these pages, a picture of Torii full upholstered with black structure



COLUBI

Contemporary style

Armchair by RT Design, 2000

“Design applied to furniture should not only add functionality and productivity to spaces, but also facilitate friendly and close relationships between employees.”

Design applied to furniture should not only add functionality and productivity to spaces, but also facilitate friendly and close relationships between employees. Colubi is an armchair that flees from all ornament, letting things happen. It is a truly veteran piece in the collection, since it was one of the first to be added to Viccarbe's catalogue. However, it has been able to maintain its modernity and contemporary style as the years have gone by. Success is not the result of chance but of causality.



Project on top: McCann Offices, Italy.
Interior Design: FASEMODUS + Studio AI Milan.
Pictures: Lea Anouchinsky.

Project: Saint-Gobain HQ, Paris
Photography: Sergio Grazia, Laurent
Kronental and Cyrille Dubreuil
Interiors: Kardham



Colubi Lounge Chair & Work

Office — The Colubi Lounge Chair was born to materialize the perfect balance between functionality and creativity. Colubi works perfectly in any situation: having lunch in a restaurant, an extended meeting at the office or working from home.



Project: Microsoft Office, Hamburg
Interiors: Lepel & Lepel
Photography: Martin Foddanu



Project: Generali Offices, Italy
Interior Design: mpengineering
Agency: Entis. Pictures: Lea Anouchinsky

Project on the right: Oficinas Grant Thornton, Tallin
Interior design: Ace of Space
Pictures: Märt Lillesiim

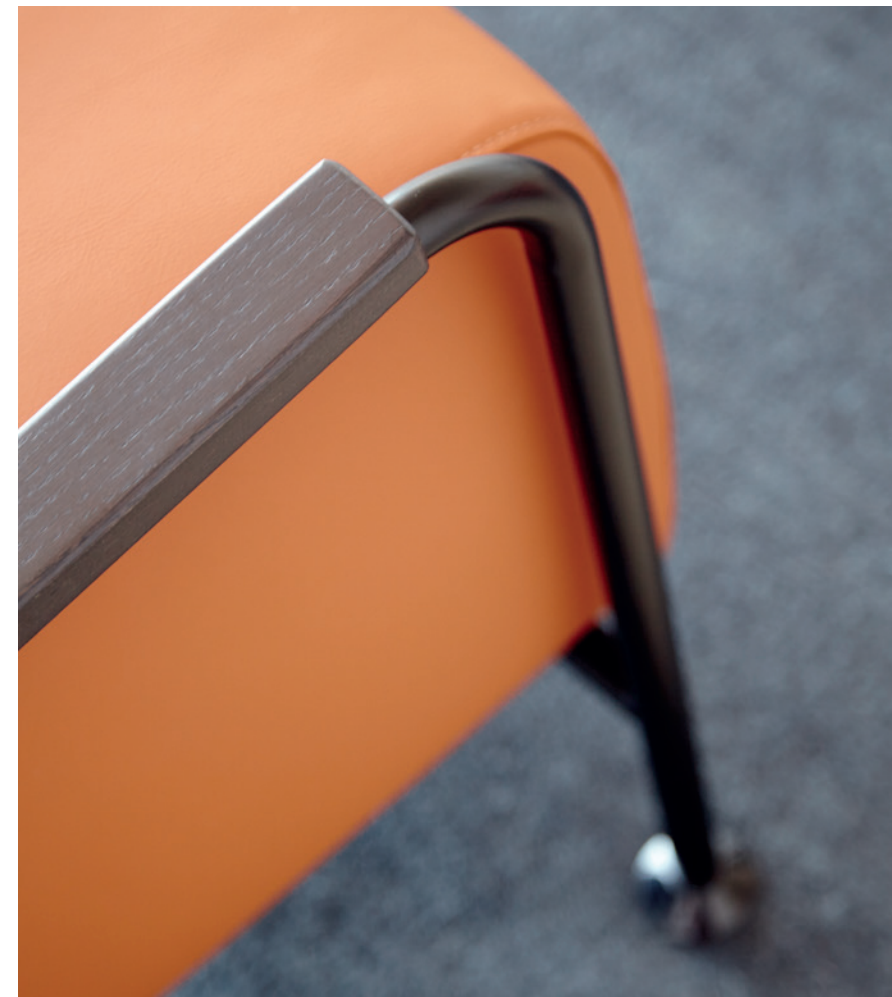

Project: Teulada Moraira Concert Hall
Pictures: Ángel Segura

Project: C4 por ERRE
Arquitectura, Valencia





Project: Spaces Belvedere, Vietnam
Interior design: Interior Architect_ D&P
Associates: Supplier_ FacilitylinQ

FEDELE

Sitting with character

Armchair & Ottoman designed by Víctor Carrasco, 2009



Some collections are born thanks to an instant, an experience of their creator. There are others that also become a thank you.

It is true that we do not always baptize new products based on a creative concept. We do not always refer to the morphology of the piece because, although a good design must be explained by itself, we do not always talk about evidence, we do not always refer to the material. Is there a bigger challenge than baptizing a new

piece? In this case, the Fedele family wanted to become an acknowledgment. This is what its name means in Italian: it was born from honesty, from a perfect balance between its rounded forms and its friendliness. Without going far from reality, the armchair and the pouf only wanted to be faithful and to live in the service of people. To stay at the time and place, to wait in the intermediate zones... To facilitate, to let the collaborative zones happen.

“Without going far from reality, the armchair and the pouf only wanted to be faithful and to live in the service of people”



On this page, a picture of two Fedele poufs. On the right page, a picture of Fedele armchair with a Mini low table lacquered in white





An ideal guest chair
for welcome areas and
lounging spots

Project: Newsec Advisory Firm, Norway
Interior Design: lark
Photography: Niklas Hart



Project: Castellón Concert Hall
Pictures: Ángel Segura



WRAPP

Balanced proportions

Armchair designed by Marc Krusin, 2005

"Comfortable and functional, Wrapp's backrest is as elegant as it is enveloping."



As its name implies, Wrapp is function and form in its purest sense. Innovation and tradition come together in this armchair, which invites you to sit back and relax. Comfortable and functional, Wrapp's backrest is as elegant as it is enveloping. Like a good host, it welcomes and takes care of the guest in all kinds of landscapes

such as hospitality interiors, collaborative spaces or meeting rooms. Wrapp, created by Marc Krusin in 2005, has an embracing design of perfectly balanced proportions, resulting in a unique and sensual shape.





Project: Ricard Camarena Restaurant
Pictures: Ángel Segura

Low tables

CAMBIO
BURIN MINI
TRINO
SHAPE
RYUTARO
MAARTEN
ALETA
GIRO
BAMBA
TIERS
SERRA
HOLY DAY
COMMON
STAN
ELI
UP IN THE AIR

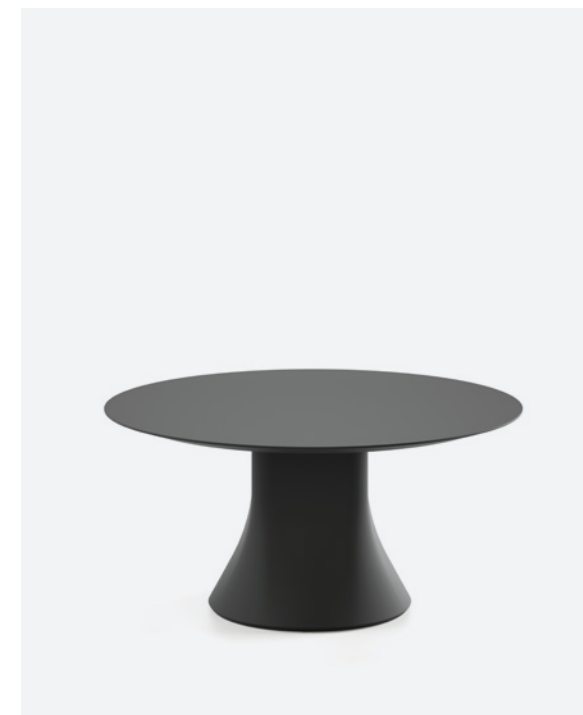

Cambio

DESIGNED BY VICTOR CARRASCO, 2022

The Cambio low table works in any area of the office or home. Defined by a singular central base with a seamless silhouette, this low table is a minimalist game of geometry based on the transition from a square to a round shape, taking us back to our origins.

On the left, featuring Savina sofa and Cambio low table in white finish. On this page Cambio low table in taupe and black finish.

Burin Mini

DESIGNED BY PATRICIA URQUIOLA, 2011

With a sculptural soul, Burin has known how to satisfy a need with strength and creativity. On this occasion, we will find form and function interacting in perfect balance.

On the right Burin Mini with different sizes in white finished



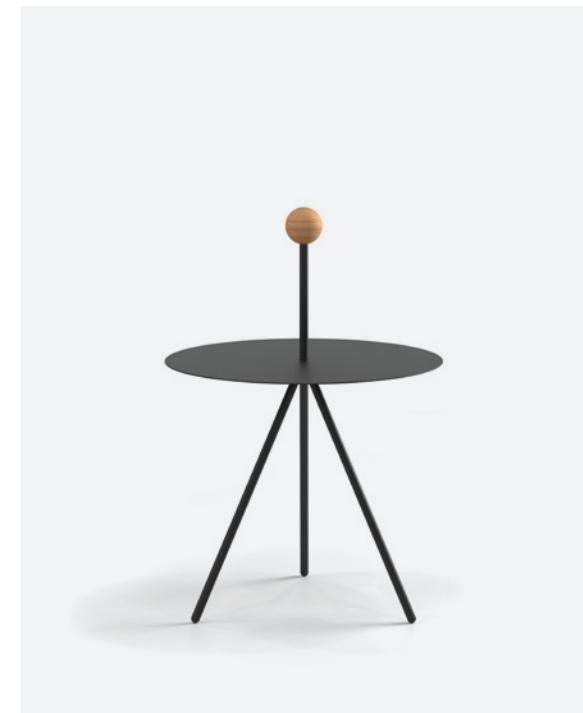
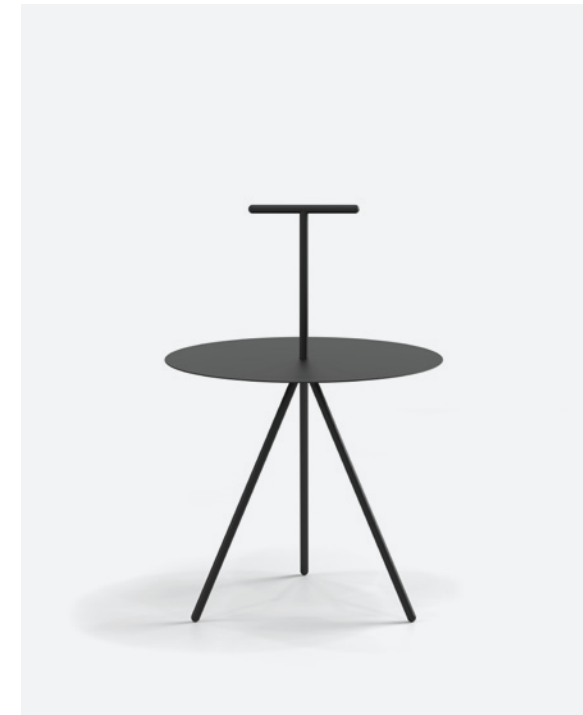

Trino

DESIGNED BY ELISA OSSINO, 2020

Trino is born with a sculptural soul and stage vocation, with the inherent elegance of a design capable of expressing and complementing all types of interiors. The Ossino tables are also easy to move thanks to its three types of handles available: a metal structure and a small sphere available in solid oak or marble.

On the left, featuring Trino Low table with marble sphere and Copa chair with 4 wooden legs in ash

Ryutaro

DESIGNED BY VICTOR CARRASCO, 2011

Ryutaro is a special low table, a nest-style auxiliary table to add a dynamic touch to any space. Its legs have a singular transparent detail at the end, adding visual lightness to any space. Thanks to the multiple finish options, Ryutaro can be used in numerous places, whether at home, in the office or in different architectural settings.

On the right, Ryutaro table en white, matt oak and taupe finished





On the left, featuring Levitt armchairs and Maarten low table in matt oak finish. On this page Maarten low table wit brick tabletop

Maarten

DESIGNED BY VICTOR CARRASCO, 2014

Maarten low table, designed by Victor Carrasco, is the ideal complement for collaborative spaces, meeting rooms, welcoming areas, and homes. A light low table which facilitates interaction, acting as a comfortable support in team meetings.



Shape

DESIGNED BY JORGE PENSI, 2007

We believe in strong, personality-filled forms, in attractive and sensual curves. Above all, we believe in the power of side tables to complete the visual landscape of a space. Shape is pure character.

On the right featuring Shape low table in black finish and Season sofa





On the left, featuring Aleta lounge chair and Aleta low table with brass structure

Aleta

DESIGNED BY JAIME HAYON, 2018

The iconic Aleta collection by designer Jaime Hayon is completed with a refined low table. The piece is great to complement any chair or sofa in our range, adding a sophisticated yet relaxed allure into the room.

Giro

DESIGNED BY PEDRO-PAULO VENZON, 2017

Designed by Brazilian Pedro Paulo-Venzon, Giro is a minimalist, geometric side table with a very special design. The artistic yet functional side table combines a steel frame with a matt oak tabletop, creating a sculptural piece that represents the perfect balance between art and furniture.

On the left, Giro low table with black structure and matt oak tabletop. On the right, same piece with brass structure



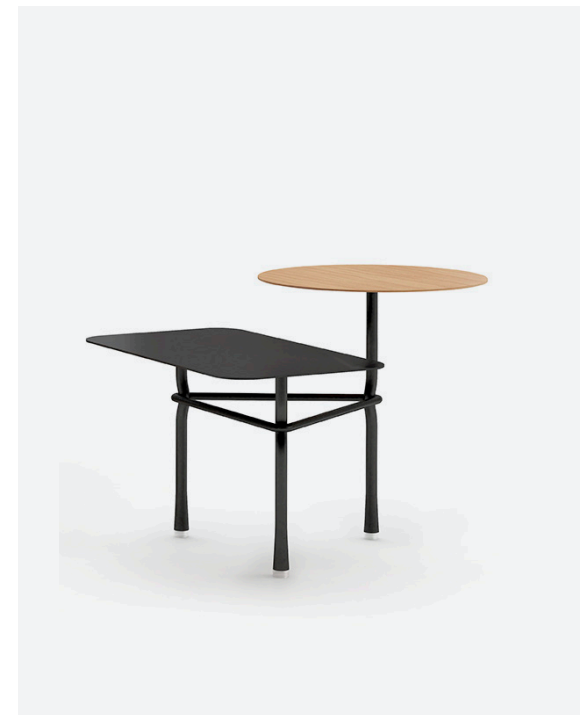

Tiers

DESIGNED BY PATRICIA URQUIOLA, 2010

Tiers is a unique low table with a relaxed style and a contemporary twist. Designed by Patricia Urquiola, it allows the creation of beautiful and infinite landscapes along a space, thanks to the different heights of its boards.

On the left, featuring Savina sofa and Cambio low table in white finish. On this page Cambio low table in taupe an black finish.

Bamba

DESIGNED BY PEDRO-PAULO VENZON, 2017

Designed by the young talent Pedro-Paulo Venzon, Bamba brings us back to the idea of a design that remains at the service of moments without renouncing its authenticity.

On the right Bamba low table in black finish and Sistema sofa





On the left, featuring Sistema sofa and Serra low table with round tabletop. On this page Serra low table with strap an black finish

Serra

DESIGNED BY VICTOR CARRASCO, 2013

Serra is a very suitable side table when it comes to complementing other pieces such as sofas, armchairs or poufs. It is a great accessory when working on the laptop or taking notes in meetings, ideal for the home or...of its boards.



Holy Day

DESIGNED BY JEAN-MARIE MASSAUD, 2004

To synthesize, it is probably the most complex exercise we can practice in the design discipline. Conceived by Jean Marie Massaud, the Holy Day table represents a concept of necessary minimalism. It merges with space and is even capable of reinterpreting it.

On the left, Holy Day with black structure and stained table top. On the right same piece.





On the left, Up in the Air Low table in black finish.
On this page featuring Nagi armchairs and Up in
the Air low tables

Up in the Air

DESIGNED BY RAMÓN ÚBEDA & OTTO CANALDA, 2014

A singular low table which is an ode to relaxation and our so cherished Japanese culture. The magic lies in its fishes floating in an air, which resembles water, with no more ornaments than themselves. A delicate and artisanal detail that conveys a special allure and a hint of mystery around the Up in the Air design.



Stan

DESIGNED BY VCCB STUDIO, 2015

In Stan we find rounded shapes and a selection of finishes to fit all kinds of spaces.

Project on the left: Banc Sabadell
Company Hub.
Project: Mateo Arquitectura
Pictures: Aldo Amoretti

On the right, featuring Sistema sofa and
Stan low table in black finish.





Common

DESIGNED BY NAOTO FUKASAWA, 2013

Auxiliary design tables for offices and intermediate establishments, inspired by the Japanese classics. The Common low tables include different sizes, making them very flexible and suitable for a great array of spaces. Great to complement the Common bench, adding a dose of comfort and practicality for users.



On the left, Common low table in two heights and white tabletop. On this page Common low table with black and taupe tabletops

Eli

DESIGNED BY VCCB STUDIO, 2015

Eli is a collection of design tables that is ideal for complementing intermediate spaces. The lightness of its aluminium base and the different size options make this table a perfect element for any environment.

On the left, featuring Season Pouf and Eli low table in black finish. On the right same pieces



Accessories

WINDOW
KEEL

DESIGNED BY VINCENT VAN DUYSSEN, 2006

This collection of coat racks and umbrella stands materializes the usual serenity and sensuality of the pieces conceived by the architect Vincent Van Duysen.

Inspired by Donald Judd's minimalist sculptures, the 'windows' of the rack were carefully designed for the proper care and hanging of clothes. His special attention for hidden details and the elimination of excess is a constant in his work: the result is always based on values such as warmth and emotion.

Let's talk about visual poetry.



Accessories are not
only complementary
elements



On this page, a picture of a free standing coat hanger and an umbrella stand in black finish

Window Collection



Keel Collection



DESIGNED BY VÍCTOR CARRASCO, 2018

Inspired by nautical constructions, in 2018 he gave life to a new concept of shelving, free of predefined forms and compositions. Made of solid oak wood, this family of shelves can be configured to suit an infinite number of aesthetic tastes, colors and needs.

The wall thus becomes a blank canvas on which it is possible to accommodate the most personal objects or simply to have the freedom to draw.

The choice will be purely personal: to give a space a subtle character or to make room for your objects. Keel, in this case, gives us the gift of creativity.

On the left page, a picture of Keel shelves in matt oak.
On the right page, a detail of a Keel shelf in matt oak

There is no
disease more
difficult to cure
than habit, that's
what I run away
from in my
projects



Quick Expedition is our selection of furniture with express production to help you meet project deadlines.

Includes two product categories with different expedition times: 5 business days for non-upholstered (chairs, stools, tables, low tables and accessories) and 15 business days for the upholstered lot (chairs and armchairs).

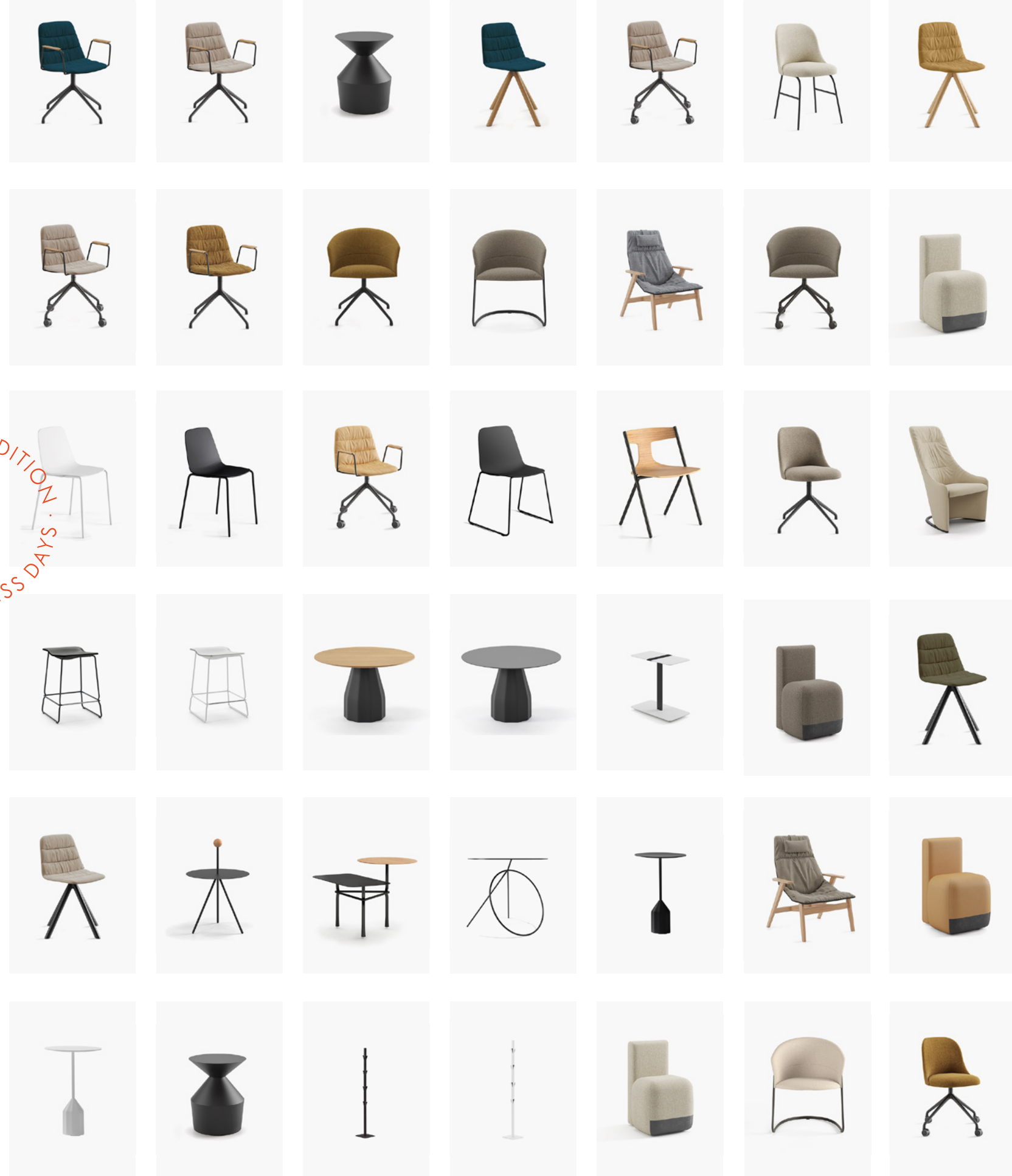

QUICK EXPEDITION
. 5 & 15 BUSINESS DAYS .

QUICK
EXPEDITION

Coming

Soon

Our collection is a living story that is constantly reviewed and updated. Our teams work hard to offer the best collaborative pieces and solutions in the market for your offices, collaborative environments, homes and hospitality spaces.

In the following pages you will find a sneak peak of our upcoming projects with renown designers. Collections in a working process, thought always to be timeless, comfortable and iconic. Come and see.

NEXT SEASON

COMING SOON

NEXT SEASON

NEW, *by* JASPER MORRISON



2022

Our first joint-venture with Jasper Morrison, a collaboration which has matured in time, slowly and thoughtfully. The result is a new bistro style piece, inspired in the “Super Normal” work of the designer. One measurement, one height, but infinite combinations to shape a remarkable table sketched from the ordinary, transformed into something extraordinary.



COMING SOON

NEXT SEASON

NEW, *by* JOHN PAWSON



2022

In ancient roman culture, Foro (latin forum) was the place to gather, the meeting point where citizens commonly carried out their social life, and financial, religious, commercial, and economic duties. This word has been the inspiration for the new table designed by the British designer, which sums up this concept with great precision and consciousness. A new product made for conversation, idea exchange, feasting, collaborate, and share a lifetime.



COMING SOON

NEXT SEASON

NEW, *by* STEFAN DIEZ



2022

The commitment to maximum sustainability and comfort raised Funda, the conscious range of seats by designer Stefan Diez. Due to its success, we have now incorporated a new seat to the line up which is wider, bigger and even more enveloping.

An extra large armchair with matching footrest, crafted with pure technique and the minimum components, only structure and upholstery shape the armchair without losing an ounce of durability, sustainability or comfort.



Latest international projects

Viccarbe is present in over 80 countries on five continents. We bring the warmth and hospitality of our Mediterranean character to create longlasting partnerships, always focus to provide our customers with an excellent shopping experience at Viccarbe. Whether in San Francisco or in Tokyo, our team of professionals will share their passion in providing excellent services and will introduce you to the way we understand design.

(1) Cr8, Allen & Overy, Praga; (2) Columbia Distributing, USA; (3) Merkato Hub, Spain; (4) Unity Offices, Calgary; (5) Vanalinna Ehitus Office Extension, Lithuania; (6) IBM Studios, Milano; (7) Linksquare Shinjuku, Japan; (8) Advisory Firm, Valencia; (9) Christian Dior, Shanghai; (10) Project by Luc Voisin, France. (11) Utah Jaredmedley Offices, USA; (12) Farmacias del Ahorro, Mexico; (13) People Offices, Greece; (14) France Offices, France; (15) Amgen HQ, Athens; (16) LVMH Offices, France; (17) Arivetz Offices, Lyon; (18) Xing Dong Network, China ; (19) TUI Offices, Stockholm; (20) Santa Maria Business & Conference Center, Panama; (21) Spazio Showroom, Tallin ; (22) Château De Panery vineyards, Pouzilhac; (23) Parador Costa da Morte, La Coruña; (24) Tres Mares Offices, Madrid; (25) Banc Sabadell Company Hub, Valencia; (26) Shiseido Global Innovation Center, Japan; (27) NH Hotel Nhow, Amsterdam; (8) El Telar de Miquel Martí, Valencia.





11



12



17



18



13



14



19



20



15



16



21



22



Our Clients

We are grateful for the people and companies that work with our products worldwide



Quality

We are present in more than 80 countries. Our production is carried out in Spain under the environmental certification ISO 14001 and ISO 9001. Our products are ANSI BIFMA and UNE certified, with a factory warranty of 5 years.

Viccarbe has a demanding environmental certified project fruit of our total commitment to the sustainable manufacturing program. We use certified wood in all products indicated.



Responsibility

A large part of our work at Viccarbe is devoted to the balance of our designs. By the same token, we understand that only a balanced, responsible society will lead to a sustainable future.

From Responsibility by Viccarbe we participate in innovative social projects to contribute to live in a better environment. For further information, please contact: responsibility@viccarbe.com

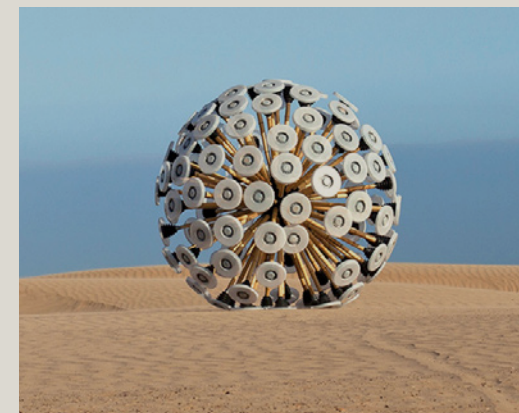

MAMÁS EN ACCIÓN

Mamás en Acción is a community formed by people who accompany children who don't have parents or don't have the possibility of living with them, staying alone when they shouldn't (both in challenging moments, such as hospitalisation, or the celebration of their birthday).

We at Viccarbe support this organisation putting in practice different actions, with the sole purpose of turning the wellbeing of these children into a priority and contributing to not find any child who doesn't feel supported or protected.

<https://mamasenaccion.es/>

EL ARCA DE NAZARET

We collaborate as well with the association El Arca de Nazaret, specially devoted to protect children, teens and their families' rights who suffer inequalities at their personal and social development.

<https://elarcanazaret.org/>

MINE KAFON

Viccarbe collaborates actively with Mine Kafon, an airborne demining system developed to clear all land mines around the world in less than 10 years.

<https://minekafon.org/>

CASA CARIDAD

Viccarbe believes in people and always tries to support them. In the past ten years, we've been collaborating with the association Casa Caridad in Valencia.

<https://www.casacaridad.com/>

pCon Planner

With the hype of the digital era, professionals in the world of architecture, interiors, decoration or design are using online platforms and tools that aim to improve and facilitate their work through the creation, design and distribution of layouts and drawings in 3D.

Through these online applications, professionals can design sketches and draw plans easily before even starting to build anything, helping them to get a more precise idea of what the project will look like before it goes into making.

If you are looking to simplify your work, plan layouts and projects easily plus prepare simple budgets of your proposals in just one click, in this new Viccarbe post we tell you everything you need to know about the free pCon.Planner tool and how it can help you when space planning.

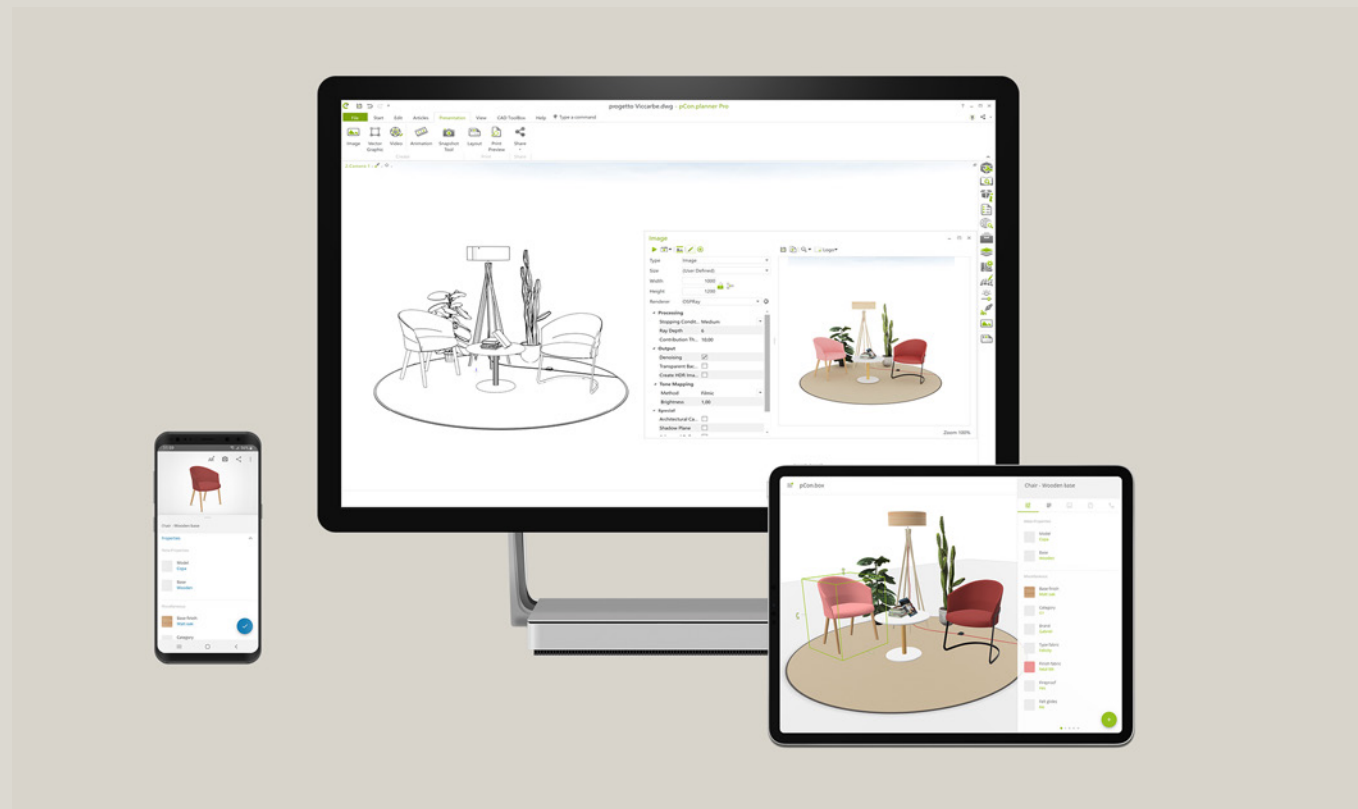

Configurator

In order to help you find the perfect match for your projects, our website incorporates a virtual product configurator. You can mix and match different finishes to find the ideal fit for your space, visualize it in real time thanks to the augmented reality feature and quickly request a quote so you can find easily what you require.

Discover more at www.viccarbe.com/configurator

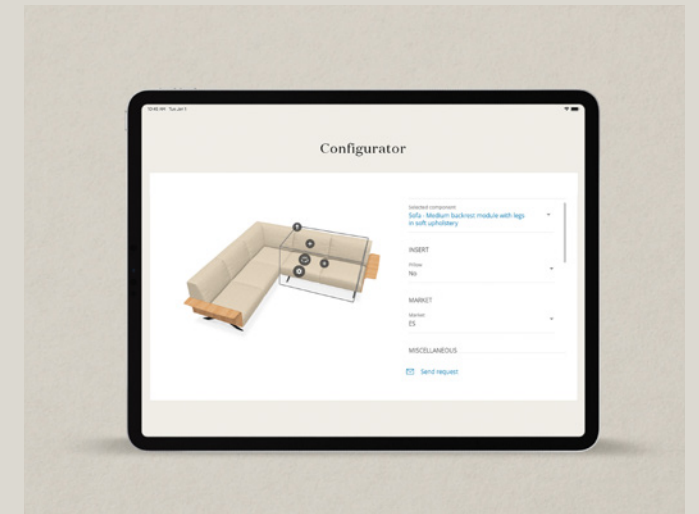

The Journey to Sustainability

Friendliness and positivism are inherent values to the Mediterranean culture. Today we start a new series of facts around sustainability, a new manifesto with the aim of inspiring environmentally-friendly attitudes around the world.

Let's write together the journey to a more respectful society.

#1 – PROXIMITY

Is there a greater way to look for sustainability than keep on developing the local industry? For Viccarbe, it's been 20 years focusing the production around the marvelous city of Valencia and avoiding unnecessary transports between all our suppliers. But the only constant is change. And that has just been the starting point of a long-term project...

#2 – PACKAGING

Let's not forget our packaging... It's not just about the product itself, but also about the way it has been protected and transported to its final destination. Years ago, our Quality team decided to reduce the impact on the environment by implementing boxes made at least of 80% recycled cardboard.

#3 – MAKING EVERY PRODUCT'S LIFE-CYCLE LONGER

The pursuit of innovation and sustainability comes not only when devising new products, but also when offering the possibility of replacing specific parts of a piece of furniture, making the products' life cycle longer and minimizing the waste of energy in the productive process.

#4 – WOOD, THE ORIGINS OF THE INDUSTRY

In average, the wood from oak trees allows furniture pieces to last the double of time than the ones made with wood from fast-growing trees. Since the very beginning of Viccarbe's journey, we have used FSC and PEFC certified wood in our production, that comes from controlled and sustainable logging in Europe.



#5 – PLASTIC, THE EVOLUTION

Plastic is not the enemy. It's a clever ingredient when designing affordable, democratic and long-lasting furniture. But it needs to be recyclable and -if possible- recycled. Its lightness, easy-clean surface and resistance to environmental changes such as temperature or natural light, allow us to keep these furniture pieces made of polypropylene during decades. It's all about durability...

#6 – FABRICS DO MATTER AS WELL

When producing a new furniture piece, it's important to focus on sustainability in every single component. The conversation should not be exclusively about plastic or wood... That's the reason why we decided to offer a selection of graded-in fabrics 100% made of recycled materials, such as polyester. What's more: these sustainable fabrics are available from the entry price of upholstered products.

#7 – PASS THE TEST OF TIME

We believe that industrial design itself, as a discipline, should bring sustainability on the stage as an inherent value of each new product. Contemporary, timeless, and long-lasting design perfectly matches with the necessity of stop using natural resources in a careless way. Good design should be capable of passing the test of time, just as the wise teachings of ancient cultures that we still learn and apply nowadays.

#8 – SUSTAINABILITY UNDERSTOOD AS A WHOLE

2007 was the year when we received the ISO 14001 certification, thanks to our excellence in environmental management. This long-term challenge has brought us to take decisions such as changing our electricity company: today we can proudly say that the total amount of electricity used in our headquarters comes from renewable energy sources.



FABRICS & SAMPLES

Viccarbe is present in over seventy countries on five continents. We bring the warmth and hospitality of our Mediterranean character to create lasting partnerships, always focus to provide ou.

01

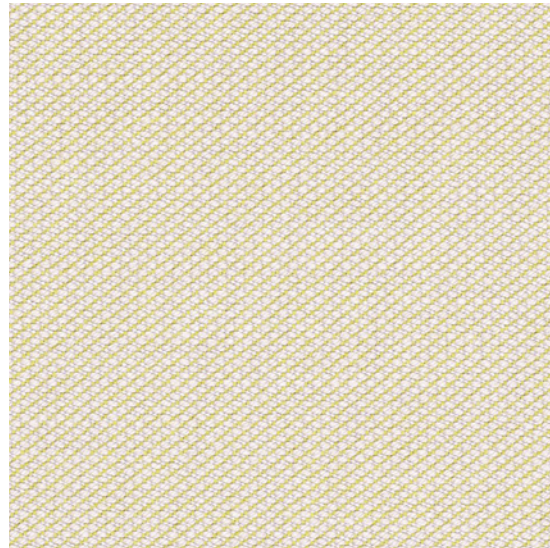

Scan to view the full samples

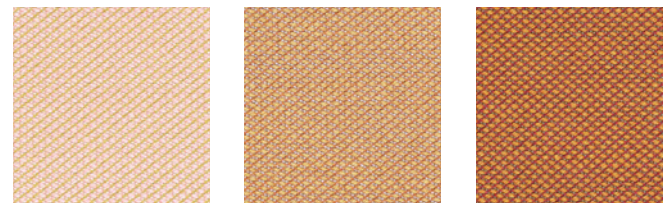

02

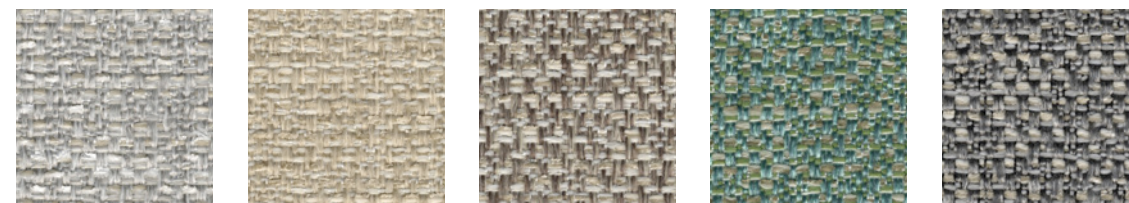

03



04

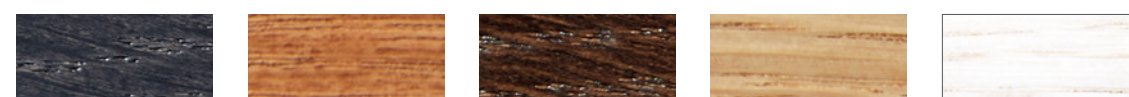

01. Kvadrat fabrics (Steelcut Trio), 02. Crevin fabrics (Gaudi), 03. Some of lacquered woods samples, 04. Stained wood samples

VICCARBE UNIQUE

There are many things that make you unique. Our new Viccarbe Unique program is born to help express your brand's identity through bespoke pieces. Viccarbe Unique features customization for some of our collections to make them even more singular and adjusted to your requirements. It is all about creating one-of-a-kind items to impact for a lifetime and, showcase your firm's philosophy. To have your own Viccarbe Unique piece, with your logo or your company name, you can choose from having it engraved or embroidered.

Engraving. Thanks to the most innovative laser technology, we are now able to engrave an image on stained wood with precision and optimum quality. You can personalize many of our collections in matt oak.

Embroidery. We can embroider your logo, message or company name onto any of our upholstered product families to create a custom piece for any area of your space. A singular feature available for the complete Viccarbe portfolio.



On this page, examples of Viccarbe Unique pieces. On the right, Quadra chair with engraved logo



Viccarbe 3D Awards

This is our first international design contest, brought up to recognize the talent of the young and professional designers that wish to provoke change and freedom of promoting spaces that foster collaboration in all its facets.

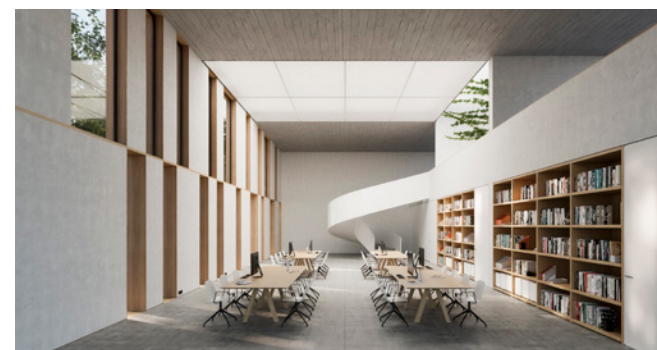

OVER 150 PARTICIPANTS FROM AROUND THE WORLD

The first edition of our digital competition saw over 150 participants from different countries. They had the challenge of creating collaborative spaces with our collections, places to foster collaboration, teamwork and interaction between people. The next edition will launch very soon on viccarbe.com.

On the left page, image from @pacalcina (first winner). Second image from @emestudio3d (second winner)

Credits

Concept & Art Direction

Vicarbe



Príncipe Felipe Award
for business excellence