

new perspectives



furniture
lighting
accessories

on scandinavian design

New Perspectives

Creating Intentional Spaces as Professionals	4
Between Imagined and Physical Space	80
Our Sustainable Perspectives	84

Spaces

Working Meeting	6
Socializing	18
Dining	32
Staying	46
Outdoor	64
	74

Toolbox

Professional's Toolbox	88
Find Out More	232

Collection

Furniture	
Fiber Chair	92
Oslo Chair & Sofa	122
Cover Chair	128
Loft Chair	132
Workshop Chair	134
Nerd Chair	135
Visu Chair	136
Outline Sofa	146
Connect Modular Sofa	156
Connect Soft Modular Sofa	158
In Situ Modular Sofa	159
Doze Lounge Chair & Ottoman	160
Wrap Lounge Chair	162
Echo Pouf	163
Five Pouf	163
Linear System	164
Linear Wood	174
Midst Table	175
Workshop Table	175
70/70 Table	176
Earnest Extendable Table	177
Base Table	178
Still Café Table	182
Soft Table	183
Couple Coffee Table	187
Workshop Coffee Table	187
Around Coffee Table	188
Airy Coffee Table	189
Relate Side Table	190
Flow Trolley	190
Compile Shelving System	191
Stacked Storage System	192
Mini Stacked Storage System	194
Enfold Sideboard	195
Outdoor	
Linear Steel	197
Fiber Outdoor Chair	201
70/70 Outdoor Table	202
Outdoor Lighting	202



Lighting

Strand Pendant Lamp	204
Rime Lamp	205
Ambit Lamp	206
Top Pendant Lamp	208
Calm Wall Lamp	209
Fine Lamp	210
Under The Bell Pendant Lamp	212
E27 Pendant Lamp	213
Fluid Pendant Lamp	213
Grain Pendant Lamp	214
Unfold Pendant Lamp	214
Tip Lamp	215
Post Lamp	216
Leaf Lamp	217
Linear Lamp	218
Set Table Lamp	219
Dedicate Lamp	220
Beam Table Lamp	222
Piton Portable Lamp	222
Ease Portable Lamp	223
Portable Charging Station	223

Accessories

Arrange Desktop	225
Sketch Toolbox	225
Story Pinboard	225
Compile Bookend	225
Reduce Paper Bin	225
Restore Round Basket	226
Restore Basket	226
Restore Tray	226
Dots - Wood	226
Dots - Metal	226
Dots - Ceramic	226
Attach Coat Hook	227
Coil Coat Rack	227
Avail Coat Rack	227
Folded Shelves	227
Framed Mirror	227
Arced Mirror	228
Ridge Vase	228
Kind Vase	228
Silent Vase	228
Platform Tray	228
Raise Carafe & Glasses	229
Corky Carafe & Glasses	229
Wave Tray	229
Mere Bowl	229
Tub Jug	229
Pebble Rug	230
Ply Rug	230
Relevo Rug	231
Varjo Rug	231
Relevo Rug	235
Varjo Rug	235



new perspectives on scandinavian design

Muuto is rooted in the Scandinavian design tradition characterized by enduring aesthetics, functionality, craftsmanship and an honest expression. By expanding this heritage with forward-looking materials, techniques and bold creative thinking, our ambition is to deliver new perspectives on Scandinavian design.

In fact our name, Muuto, comes from muutos, meaning new perspective in Finnish. We handpick leading contemporary designers who are strong interpreters of our philosophy and combine their talents with the passionate Muuto creative team.

You will know our design because it has muutos: objects made sublime through new perspectives, enjoyed across the world, representing the best of Scandinavian design today.



creating



intentional spaces as

Exploring new perspectives on Scandinavian design is key to Muuto's forward-looking, innovative designs. Intuitively knowing that design has the capacity to greatly affect the way we feel, we continue to believe in the importance of creating intentional atmospheres through a thoughtful selection of furniture, accessories, and lighting.

Intuitively, we all know the feeling of entering a room and immediately feeling at ease or stimulated. That interacting with elements of design—be it sensations of light, color, or texture—can trigger emotions and spark a dynamic interplay of neurotransmitters in our brains. This process can shape our feelings, thinking and behavior. There is more to design than meets the eye.

The impact of neuroaesthetics on design and spaces
Neuroaesthetics is about mind-body connection: a scientific discipline that explores and measures how creative expression makes an impact on us. It gives a deeper understanding of the way art, design, and architecture activate our senses and stimulate our sense of well-being. Understanding how we respond to different spaces allows us to better discern the connection between body, mind, and design.

Through our longstanding collaboration with Susan Magsamen, executive director of the International

Arts + Mind Lab at Johns Hopkins University, we have explored design's potential for producing well-being. This journey began with our exhibition at Milan Design Week already back in 2019 and has since inspired us to create more intentional objects and spaces.

Today, our approach to designing spaces is driven by five guiding principles of neuroaesthetics: Nature, Light, Form, Color, and Tactility—while remaining open to the potential for further expansion and refinement of these principles, recognizing the ongoing evolution of this field.

A space that feels just right

There are many lessons to be learned from neuroaesthetic research and principles when it comes to designing spaces for many. While places for healthcare, hospitality, education, and office each come with a set of practical requirements, it should not all be about functionality and utility.

For instance, applying natural elements like greenery and materials such as wood, wool textiles, ceramics, or clay into office spaces or patient rooms has been demonstrated to lower stress levels, promote feelings of calmness, and aid in faster recovery processes. Similarly, light allows us to enhance performance in schools or induce a sense of serenity at our favorite

professionals

When you have heightened aesthetic experiences... They change you. They change your biology. They change your mood. They change your emotion.

— Susan Magsamen, Executive director of the International Arts + Mind Lab at John Hopkins University



Creating intentional spaces means fashioning a place where many can feel at ease, energized or an innate sense of belonging.

hotel. Soft shapes have been proven to feel intuitively good, while color has the power to energize or soothe. Why not merge them in a deep seat upholstered in a tactile textile that speaks to our sense of touch—at the restaurant, reception, or lobby?

It all has to do with the space and intention: what kind of setting are we trying to create? And what should it make us feel? Bringing people together in the office requires a vastly different approach from designing a space for focused work. Taking cues from the field of neuroaesthetics enables us to make more informed decisions when designing a space, tailored to the people using it and the activities that take place. It allows us to create intentional spaces that change according to user and need, all while promoting well-being.

We hope our perspectives on Scandinavian design will inspire you to reflect on your surroundings. As you browse through this catalog, let our pictures and words inspire you — and encourage you to create spaces that feel just right for your projects.

working

6



Today, work is not merely done at the office and rarely in a single place throughout the day. As we perform a diversity of tasks, we seek an equally diverse range of spaces to create, connect, think and relax. From the hushed and intimate to the collaborative and social – the agile workplace needs to accommodate focus, collaboration and temporality.

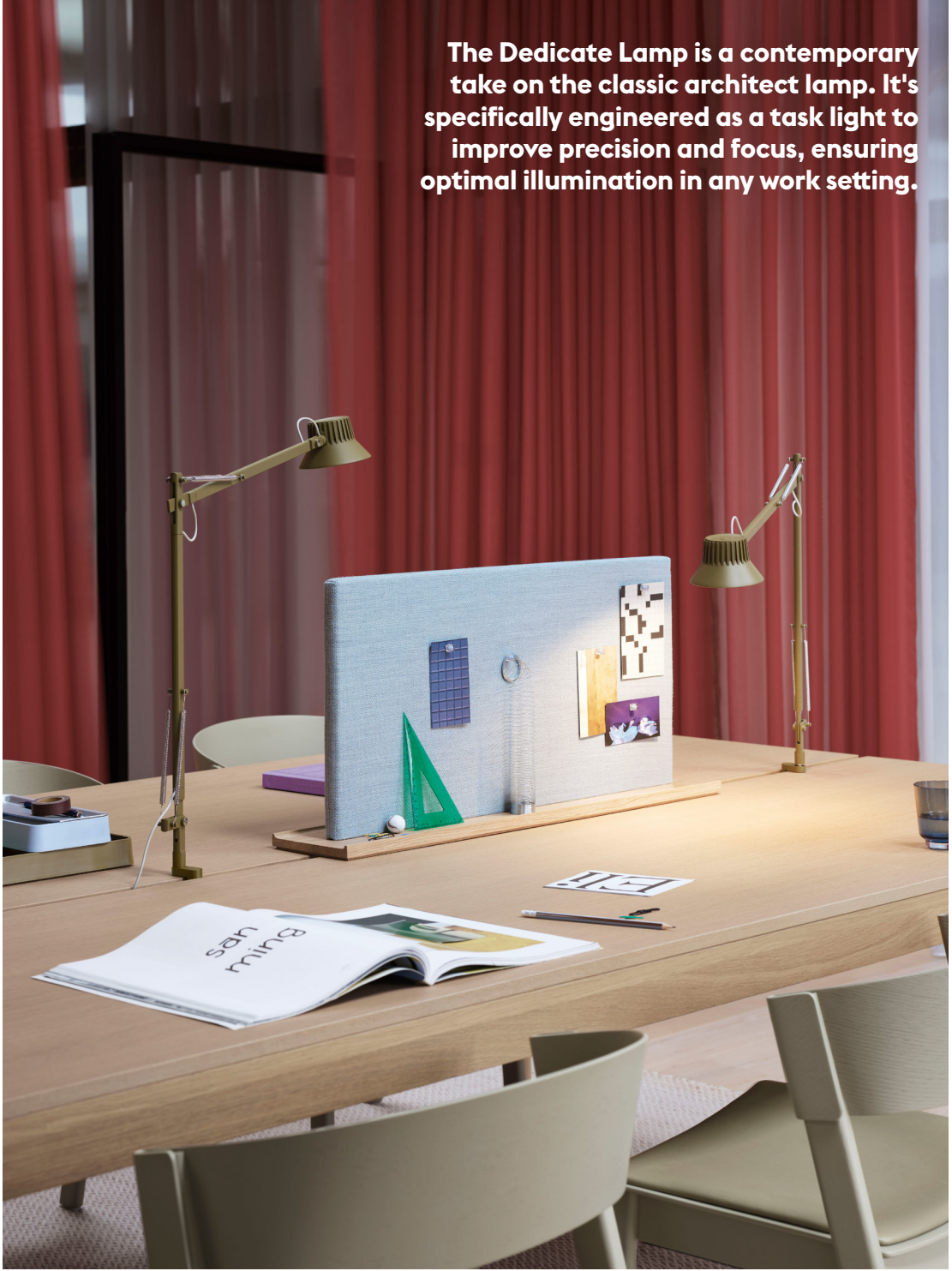
Muuto's extensive collection allows one to create flexible, contemporary spaces with a distinctive sense of homeliness, be it quiet and touchdown spaces or agile places for co-working and desk sharing. By incorporating elements of adaptability and personalization, our pieces address the needs of an increasingly nomadic workforce. Together, these forge interiors where we feel intuitively at ease, wherever we chose to work from.



Linear System Table pp.166-173
Linear Screen p. 169
Upholstered in Fiord 721

Cover Side Chair p. 199
Dedicate Lamp pp. 220-221

Arrange Desktop Series p. 225



The Dedicate Lamp is a contemporary take on the classic architect lamp. It's specifically engineered as a task light to improve precision and focus, ensuring optimal illumination in any work setting.

Linear System Table pp. 166-173
Linear Mounted Lamp p. 168

Linear Tray p. 169
Linear System Table Power Outlet p. 171

Fiber Side Chair p. 110
Upholstered in Sabi 631

Wrap Lounge Chair p. 162
Upholstered in Fiori 451

Post Floor Lamp p. 216



The Linear System Series in all black offers a refined and graphic expression in a fully monochrome configuration with its dark hue elegantly emphasizing the sleek silhouette.







Story Pinboard p. 285
 Restore Basket p. 286
 Pixon Portable Lamp p. 292

Workshop Table p. 175
 Tip Table Lamp p. 215
 Sketch Toolbox p. 225

Fiber Side Chair p. 119
 Upholstered in Twill Weave 620



working



The Dedicate Lamp, available in various sizes and with different bases, provides a *versatile* lighting solution tailored to meet the diverse needs of *home offices* and workspaces alike.



Linear System Table pp. 166-173
Linear Mounted Lamp p. 168

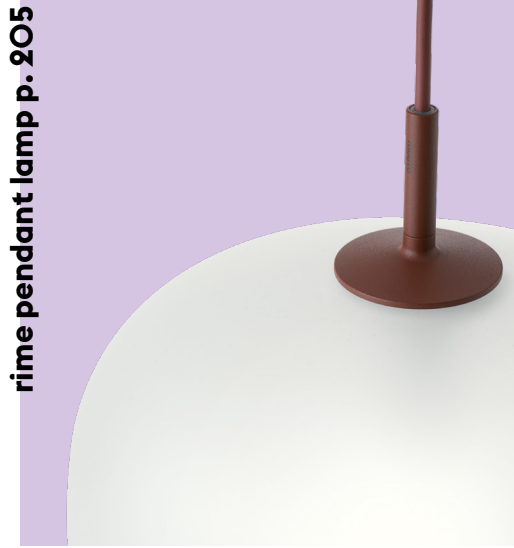
Linear System Table Power Outlet p. 171
Loft Chair p. 132

Compile Shelving System p. 191





Add subtle yet impactful dashes of color to touchdown spaces through side tables and poufs for working, relaxing and leisure.



rime pendant lamp p. 205

Outline Highback p. 152
Upholstered in Vidar 222 & 363

Echo Pouf p. 163
Discontinued upholstery. Replaced with
Vidar 1062, Vidar 633 & Steelcut Trio 436

Relate Side Table p. 190
Rime Pendant Lamp p. 205
Ply Rug p. 230

Echo Pouf p. 163
Discontinued upholstery. Replaced with
Vidar 1062, Vidar 633 & Steelcut Trio 436

Relate Side Table p. 190
Ply Rug p. 230



working

The Linear System Series is a modular system for the modern workspace, bringing warm materiality and feelings of home into daily work life.



Fiber Side Chair p. 111
Upholstered in Balder 432
Compile Shelving System p. 191

Linear Pendant Lamp p. 168
Linear Table Power Outlet p. 171

Linear System Table pp.166-173
Linear Screen p. 169
Linear Mounted Lamp p. 168

Base Table p. 178-181
Fiber Side Chair p. 110

Tip Table Lamp p. 215
Base High Table p. 178-181

Fiber Bar Stool pp. 115-116
Ambit Rail Lamp p. 207



**Create dynamic working positions
throughout the day with the Base
High Table and Fiber Bar Stools.**

meeting

18



Today's meetings can take many forms; the informal or not-so, creative brainstorming sessions or even conferences with hundreds of attendants. Some meetings are short and casually done standing at a high table, while others are prolonged with a need for added comfort, at a conference or in a board room.

Muuto offers a uniquely versatile collection of furniture, lighting and accessories with an extensive range of colors, materials and textures allowing one to add character, functionality and something unexpectedly evocative to the places we meet – be it bold and vibrant or refined and subtle.

Explore Planning Ideas



The Fiber Conference Armchair with its spacious and comfortable seat, is perfect for long meetings, offering unparalleled comfort over extended periods.





Connect Modular Sofa pp. 156-157
Upholstered in Acca 731

Fiber Soft Armchair p. 95
Upholstered in Hearth 8

Stacked Storage System pp. 192-193
70/70 Table p. 17/6
Raise Carafe & Glasses p. 229

Fine Wall/Ceiling Lamp pp. 210-211
Dedicate Lamp pp. 220-221



The Fiber Soft Armchair seamlessly blends *ultra-soft* seating with ergonomic support, providing an *ideal balance* of comfort and style for extended meetings.



70/70 Table p. 176
Raise Carafe & Glasses p. 229

Fiber Soft Armchair p. 94
Upholstered in Ecriture 240

Fiber Soft Armchair p. 95
Upholstered in Hearth 8



Fiber Armchair p. 103
Upholstered in Refine Leather Cognac

Midst Table p. 175
Enfold Sideboard p. 195

Strand Pendant Lamp p. 204
Silent Vase p. 228

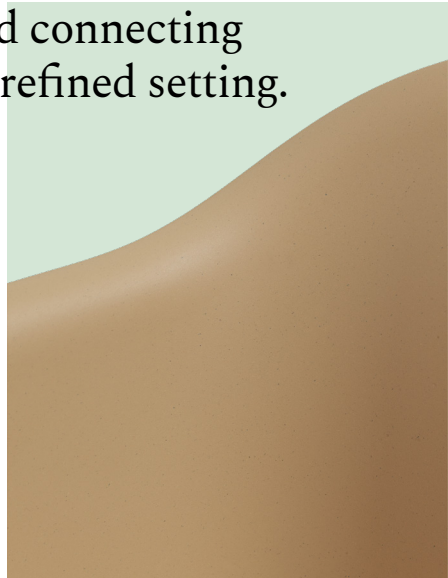


Corky Carafe & Glasses p. 229

Base Table pp. 178-181
Unfold Pendant Lamp p. 214

FiberSide Chair p. 111
Upholstered in Steelcut 615, 935, 265,
605 & 160

Muuto's continuous exploration of color, materiality, and *texture* offers an intriguing palette to help one discover, play, and *create evocative spaces* for meeting and connecting in a vibrant or subtly refined setting.



meeting





The slender silhouette of the Fiber Chair in 100% recycled plastic and FSC™-certified wood fibers, is space-efficient while its spacious interior offers optimal comfort – ideal for meeting rooms and auditoriums.

Outline Highback Work p. 154
Upholstered in Divina 984
Ply Rug p. 230

Outline Highback Cabin w. Table p. 153
Upholstered in Balder 432
Five Pouf p. 163
Upholstered in Fiorid 451

Echo Pouf p. 163
Discontinued upholstery.
Replaced with Ecriture 710.
Linear System Table pp. 166-173

Fiber Side Chair p. 110
Upholstered in Divina Melange 647 & Balder 432
Strand Pendant p. 204







Create agile meeting spaces with the Base High Table on castors, allowing users to move it in response to their current spatial needs.



Oslo Side Chair p. 194
Upholstered in Ocean 32

Base Table p. 178
Strand Pendant Lamp p. 264

Kink Vase p. 228





Linear System Table pp. 166-173
Linear Trays p. 169

Fiber Side Chair p. 107
Upholstered in Fiori 721, Hallingdøl 224
& Divina MD 913

Under The Bell Pendant Lamp p. 212
Raise Carafe & Glasses p. 229

Enfold Sideboard p. 195



Visu Bar Stool p. 144
Base High Table pp. 178-181

Under The Bell Pendant Lamp p. 212
Restore Basket p. 226

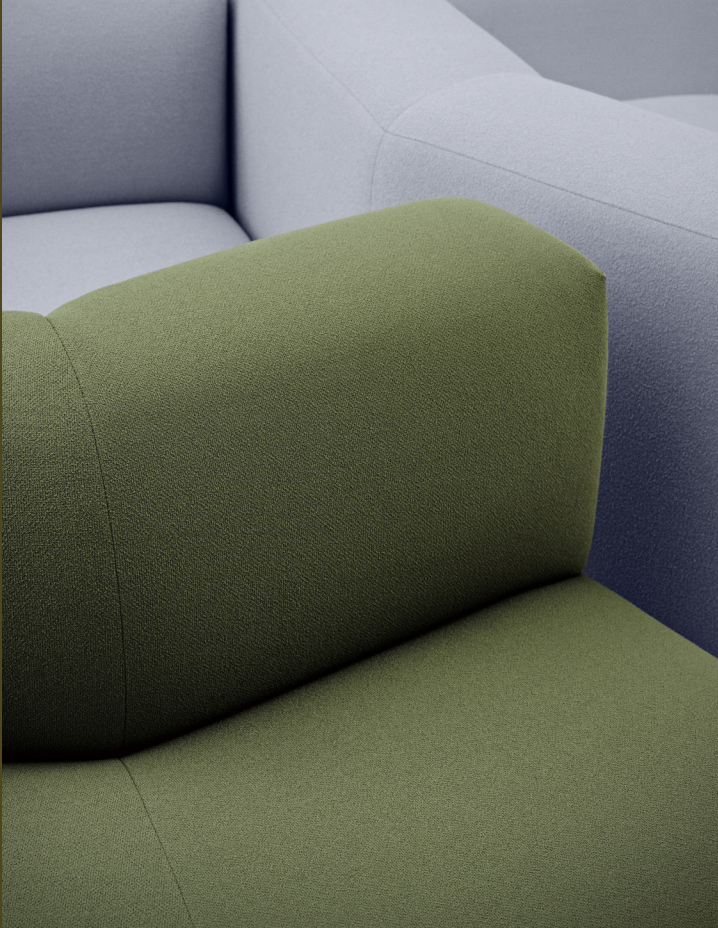
Visu Chair p. 138
Base Table p. 178-181

Made with up to 41% *recycled plastic*, the soft shade of Under The Bell Pendant Lamp creates an *intimate, encompassing feeling* within the open office space.



socializing

32



Be it a hotel lobby, public space or a lounge at the office, a social space is a place for connection, a focal point around which we gather for informal conversation, creative exchange and unexpected meetings. It is the heart of the community for work and leisure.

Our collection offers softly inviting lounge chairs, sofas, benches, and other design objects that enhance the spaces where we come together. These often make the important first impression, communicating identity through color, composition, and form, compellingly telling the story of a brand or company.

Explore Planning Ideas



Connect Modular Sofa pp. 156-157
Upholstered in Acca 731

Soft Coffee Table p. 185
Ply Rug p. 230

Ease Portable Lamp p. 223
Soft Side Table p. 186



Connect Modular Sofa pp. 156-157
Upholstered in Acca 731

Soft Coffee Table p. 185
Soft Side Table p. 186

Ply Rug p. 930
Ease Portable Lamp p. 223

Leaf Floor Lamp p. 217
Fine Wall/Ceiling Lamp pp. 210-211







Ply Rug p. 230
Post Floor Lamp p. 216
Kink Vase p. 228

Oslo Sofas p. 126
Upholstered in Vidar 772



With its *small* footprint, the Fiber Lounge Armchair fits perfectly in lobbies, hotel rooms, or office lounges, *creating cozy spots* for conversations or relaxation.



Kink Vase p. 228
Ply Rug p. 230

Soft Side Table p. 186
Post Floor Lamp p. 216

Fiber Lounge Armchair p. 119
Upholstered in Ecriture 910



Outline Highback Sofa p. 152
Upholstered in Divina 154 & Vidar 472

Fiber Lounge Chair p. 191
Upholstered in Divina 154

Around Coffee Table p. 188
Pebble Rug p. 230

Fluid Pendant Lamp p. 213



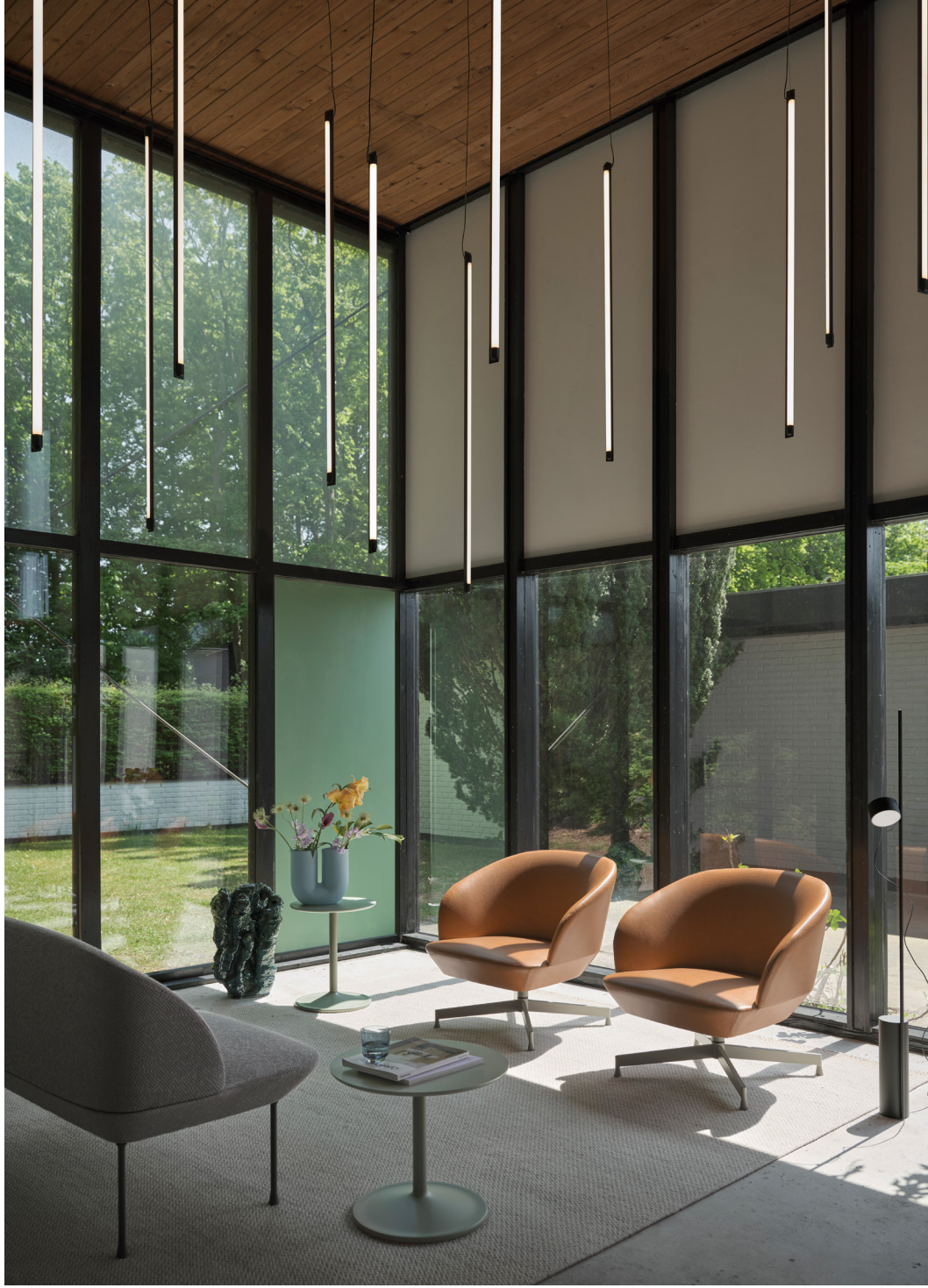
Leaf Floor Lamp p. 217
 E27 Pendant Lamp p. 213
 Ply Rug p. 230

Outline Studio Chair p. 151
 Upholstered in Steelcut 935 & Fiorid 591
 Around Coffee Table p. 188

Outline Studio Sofa p. 150
 Upholstered in Steelcut 935, Refine
 Leather Cognac & Fiorid 591

A cluster of Around Coffee Tables creates a *playful* look with plenty of table space. Opting for lighter tables allows one to rearrange according to one's needs *effortlessly*.





Oslo Lounge Chair p. 125
Upholstered in Refine Leather Cognac

Oslo Sofa p. 126
Upholstered in in Colline 147

Fine Suspension Lamp pp. 210-211
Ply Rug p. 230
Soft Side Table p. 186

Kink Vase p. 228
Post Floor Lamp p. 216

The Connect Modular Sofa, with its *flowing design* and smooth proportions, becomes the focal point in open spaces. Its *curved lines* and comfortable seats offer a cozy and inviting atmosphere, naturally *drawing* people together.



socializing

Create *welcoming* social spaces for conversation and relaxation with designs that blend *personality and warmth*, infusing lounging areas with a homely feel.



Ply Rug p. 230
Kink Vase p. 228

Ease Portable Lamp p. 223
Leaf Floor Lamp p. 217

Soft Side Table p. 186
Soft Coffee Table p. 185

Connect Modular Sofa pp. 156-157
Upholstered in Twill Weave 550 & 940

Soft Side Table p. 186
Leaf Floor Lamp p. 217
Pebble Rug p. 230

Couple Coffee Table p. 187
Kink Vase p. 228

In Situ Modular Sofa p. 159
Upholstered in Clay 12





Oversized pendants serve as a guiding element in larger spaces, bringing intimacy and harmony to a setting. Arrange them in clusters for an eclectic look or linear formations for a more formal expression.



dining

46



Our dining spaces have become an arena for informal meetings where we socialize with colleagues, friends, and family alike. Be it a bar, café, canteen, or restaurant, atmosphere, and comfort are key when setting the scene for a morning meeting or an evening-long dinner. From the embrace of an upholstered chair to functional and informal benches, Muuto's versatile collection of furniture lets you craft an outstanding dining experience with comfortable and durable quality seating. Pair these with our extensive selection of lighting and accessories, combining function with strong aesthetic qualities that truly elevate any room.

Explore Planning Ideas



Cover Side Chair p. 129
Soft Café Table p. 183

Silent Vase p. 228
Top Pendant Lamp p. 208
Raise Carafe & Glasses p. 229



Midst Table p. 175
Fiber Armchair p. 101
Upholstered in Sabi 921

Ease Portable Lamp p. 202
Rime Pendant Lamp p. 205

Raise Carafe & Glasses p. 229
Silent Vase p. 228













Enhance *intimate* settings with the Ease Portable Lamp's *atmospheric* lighting, ideal for upscale restaurants, or office coffee spots.





The *Midst Table's* round design creates a *welcoming* dining atmosphere, ideal for prolonged meals where guests are inclined to linger. Complement with soft seating and *warm colors* to enhance the overall experience.



Silent Vase p. 228
Raise Glasses, 229

Midst Table p. 175
Ease Portable Lamp p. 202
Calm Wall Lamp p. 209

Fiber Soft Armchair p. 94
 Upholstered in *Écriture* 240

FiberSoft Armchair p. 94
Upholstered in Allure Leather Mist Grey
Midst Table p. 175

Ease Portable Lamp p. 202
Calm Wall Lamp p. 209

Silent Vase p. 298
Raise Glasses p. 229





Raise Glasses p. 229
Strand Pendant p. 204
Kink Vase p. 228

Still Café Table p. 182
Ease Portable Lamp p. 202

Fiber Conference Armchair p. 94
Upholstered in Hallingdál 113

Top Pendant Lamp p. 208
Silent Vase p. 228

Cover Armchair p. 128
Midst Table p. 175





Rime Pendant Lamp p. 205
Ridge Vase p. 228

Oslo Side Chair p. 124
Upholstered in Ocean 32

Oslo Bar Stool p. 124
Upholstered in Ocean 32

Fiber Bar Stool p. 115
Upholstered in Divina Mélange 917

Fine Suspension Lamp p. 210-211
Kink Vase p. 228

Mere Bowl p. 229





Create a casual meeting area in the canteen, offering a *refreshing break* and a change of scenery during the workday, with soft colors and natural wood to ease stress and create a *homely atmosphere*.



Strand Pendant Lamp p. 205
Flow Trolley p. 190

Fiber Side Chair p. 107
Base Table pp. 178-181





Cover Side Chair p. 129
Seat upholstered in Refine Leather Black

Linear Steel Café Table p. 198
Flow Trolley p. 190

Rinne Pendant & Wall Lamp pp. 205
Tub Jug p. 229

Loft Chair p. 132
Loft Bar Stool p. 133

E27 Pendant Lamp p. 213
Corky Carafe & Glasses p. 229



staying

64



We like to consider them our second home; the spaces that we stay in for brief periods of time yet need to feel intuitively at ease in.

Be it a large hotel, small boutique space, furnished apartment or boarding house, the designs in Muuto's collection create cohesion through large product families while bringing a familiar sense to spaces we call home now and then.

Explore Planning Ideas



Stacked Storage System pp. 192-193
Tip Wall Lamp p. 215

Silent Vase p. 228

Echo Pouf p. 163
Upholstered in Acca 361





Outline Studio Sofa p. 159
Upholstered in Vidar 872

Echo Pouf p. 163
Upholstered in Acca 361

Fine Suspension Lamp pp. 210-211
Soft Side Table p. 186

Raise Glasses p. 229
Silent Vase p. 228

Raise Glasses p. 229

Stacked Storage System pp. 192-193

Tip Wall Lamp p. 215



Oslo Lounge Chair p. 125
Upholstered in Hearth 004 & Hearth 012

Leaf Floor Lamp p. 217
Soft Side Table p. 186

Silent Vase p. 228
Strand Table Lamp p. 204

Raise Glasses p. 229
Silent Vase p. 228





staying



Soft Side Table p. 186
Rime Wall Lamp p. 205

Oslo Bench p. 127
Upholstered in Hearth 010

Ridge Vase p. 228

Connect Modular Sofa pp. 156-157
Upholstered in Hearth 006

Relate Side Table p. 190
Dedicate Wall Lamp pp. 220-221

Raise Glasses p. 229





Fiber Side Chair p. 110
Upholstered in Beck 027

Workshop Table p. 175
Leaf Table Lamp p. 217

Reduce Paper Bin p. 225
Raise Glasses p. 229

Silent Vase p. 228
Arrange Desktop Series p. 225



outdoor

74



The outdoors offers a change of scenery; to unwind, clear our minds or simply break for a breath of fresh air - over a coffee, lunch break or dinner on the terrace of a favorite restaurant.

Muuto's collection of outdoor designs is distinct and modern while never compromising on comfort. Made with enduring, weather-resistant finishes in a bold range of colors, our outdoor furniture brings a sense of Scandinavian ease to any setting.

Explore Planning Ideas







Raise Carafe & Glasses p. 299
Ease Portable Lamp p. 202
Silent Vase p. 228

Fiber Outdoor Side Chair p. 201
7o/7o Outdoor Table p. 202



The Muuto outdoor collection is designed to bring a *fresh perspective* on modern outdoor living by blending indoor comfort with outdoor *durability*.



outdoor



Linear Steel Lounge Chair p. 200
Linear Steel Coffee Table p. 200

Linear Steel Bar Stool p. 197
Linear Steel Café Table p. 198

Ease Portable Lamp p. 202

Corky Glasses p. 229

Linear Steel Table p. 199
Platform Tray p. 228

Linear Steel Side Chair p. 197
Linear Steel Bench p. 199



between imagined and physical



space



Image-making studio Kühl & Han's new office is designed for focused work, collaboration and conversation—a balancing act of calm and creative energy. It is an example of how to intentionally use color, light, materiality and tactility to enhance the user experience and inspire.



Morten Kühl and Matias Hansen founded the Copenhagen-based image making studio Kühl & Han to create an alternative to what they dub ‘macho motion graphics aesthetics’, embracing a softer, more tactile approach. Their clients include Muuto, Google, Nike, and Arc’Teryx, to name a few.

The company’s new headquarters in an old umbrella factory in the bustling neighborhood of Vesterbro intertwines their work with a love of the analog, blending the borders between digital and tangible.

Craft of composition

Essentially, their work is about light and surfaces. Framing and illuminating objects and people. It is a playful process. Graphic compositions are seen as if through an analog lens, grounding the digital version of an object in something physical. The result is evocative and strangely close to what we consider ‘real life.’ It is soft and striking.

— We want it to feel as natural as possible, but also to be able to ‘direct’ nature, says Matias.

Their craft is in the small details and nuances that make something feel just right, physically compel-

ling, and recognizable. It is about materiality and tactility, the feel of a fabric. It’s technical, but the experience feels effortless. Kühl & Han are known for their exceptional knack with color, a sensitivity that also translates to their own space.

Color affects the mood

When redesigning their offices, they subtly drew these elements into their own physical environment. Bright, deep, and gentle bursts of color accentuate simple yet tactile spaces that feel spacious, dynamic, and calming.

— Some of the color choices we have made are bolder than we’ve dared to be in our workplace before. Interacting with color in this way can feel really energizing. It reflects the way we work with color, says Morten.

A forest green Outline Sofa from Muuto takes a central place in their workspace, signaling a break from the screen—shift into a different mode: art books are laid out on the Workshop Coffee Table while the Outline Daybed invites reclined rest or a casual meeting in a more comfortable setting.

Leaning on light

Light plays an essential role here, with translucent curtains filtering the copious amount of daylight, supported by a generous blend of table, floor, and pendant lamps that allow the team to adjust the light to fit the task at hand.

— Light in the office is as essential as it is to our work—even if a lot of our time is spent working digitally, explains Morten. It really impacts our mood throughout the day.

Our circadian rhythm is greatly impacted by both natural and artificial light - the amount of it, its temperature, and when we are exposed to it all play into whether we feel at ease or more alert and focused.

Making space for transformation

More formal meetings take place next door, around a deep blue-tinted solid Douglas wood table, a statement. It creates a grounding mood enhanced by the warm materiality of the Workshop Chair. Meanwhile, semi-transparent drapes enable a sense of immersion and privacy while contributing to gentler acoustics. It is a versatile and embracing space adaptable to the time of day and task ahead.

— We enjoy living in a space, gradually getting to know it rather than making all interior decisions simultaneously. It is the same for a home as for a creative office. We learn something about how to use this space optimally each day. It is in constant transformation as objects are added and subtracted, says Matias.

— Our office mixes new things with objects made by friends and second-hand furniture. Its personality is built over time.



Objects that tickle the senses

The library, with its tangerine-colored sofa, is a place for replenishing creative energy and focusing on research. Technology does not direct their process, on the contrary—their work is inspired by furniture design, among other things. Therefore, the space is not only an archive of previous work and a large collection of books, it is a library of objects of affection. Objects that inspire them, an exhibition of colors, shapes, textures, and materials that spur an instant sensation.

— We like to surround ourselves with great design when we work, it helps our creative process, says Morten.

Inviting the mind to wander

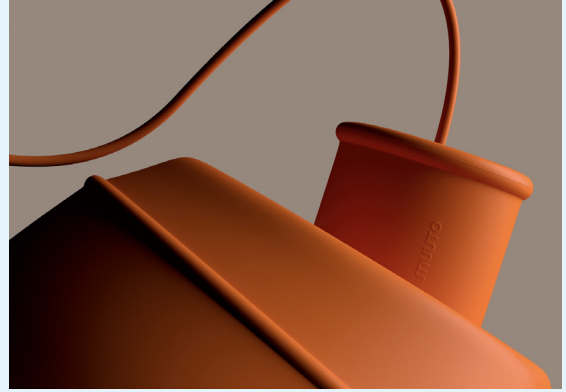
The long, rectangular shape of the office is broken up by a few walls that make up rooms with different functions. At one end, the main workspace is where the team works individually on projects, while the opposite end—the kitchen—represents communion and a break from work. Here, a sprawling Workshop Table in Black and Workshop Chairs in Oak bring the team together for lunch and conversations, a beating heart of the community.

— Our work is often focused and individual. We trust each other's process. As we are used to working remotely, we wanted to create a wide range of work settings to accommodate our team's unique needs and plenty of room to meet physically, says Matias. I like how one side of the office represents focus, the opposite winding down and chatting to each other. Carefully chosen objects of use, such as the Wave Tray in Steel, Raise Carafe and Glasses in Dark Blue, and Mere Bowl in Light Green, enable the eye and senses to wander, explore, and be gently stimulated. To rest the mind and eyes. It is a great example of how the Kühl & Han HQ combines color, light, and natural materials to create a uniquely balanced workspace, making room for the individual and the group as a whole. With all of our facets and need for quiet, connection, and inspiration.





"We like to surround ourselves with great design when we work, it helps our creative process"



our sustainable perspectives

At Muuto, we aim to take responsibility for our operations and reflect on the choices we make and how our priorities affect the wellbeing of people and the environment. From the materials we select to the partners we work with, the independent institutes we test and certify our products through, and all the way down to our packaging.

Our approach is based on knowledge and staying curious. With each new advancement in the field and as new research emerge, we keep searching for new perspectives on sustainability across all our operations. *Listening. Learning. And improving.*



**10-year warranty
for all BIFMA-
approved designs**



It starts with enduring designs

Long-lasting products

As a design-driven company, we want our designs to be appealing now—and in the future. Rooted in Scandinavian heritage, we craft timeless designs meant for passing down through generations.

Continuous testing is at the core of our development processes to keep the quality of our product high. For high levels of strength and stability, our products are certified by independent institutes that are well-respected authorities in the industry — following industry standards like the European Standard EN and the North American standard ANSI/BIFMA. Together, these industry standards assure that our designs are safe — and built to last.

All of Muuto's BIFMA-tested designs are covered by a 10-year warranty alongside a 5-year warranty on all other products.

BIFMA

Whenever we develop a new product with our designers, we reflect on the impact it will have on your health, your surroundings, and the environment

Reflecting on materials

Conscious designs

Whenever we develop a new product or improve existing ones with our designers, we reflect on its impact on your health, your surroundings, and the environment.

We continuously seek new perspectives and work with the best in our industry to learn about new techniques and materials. The search for the right materials is an integral part of our design process, and we put great importance on all the materials that comprise a design and their life cycle.

As part of this journey, we launched the new generation of Fiber Chairs made with an innovative composite of FSC™-certified wood fibers and 100% recycled plastic, designed with a wish to improve our environmental impact.



The air we breathe indoor

Healthier indoor climates

Even for indoor environments, where we spend so much of our time, the air quality is vital to our sense of well-being. In any space and often impossible to see, chemicals are emitted into the air. These emissions come from all kinds of objects in our everyday lives. The type of emissions that can have an adverse effect on our health contain Volatile Organic Compounds (VOCs). In fact, the majority of VOCs can be found at home—in certain types of soaps, perfume and cosmetics, cleaning products and disinfectants, fuel, paint, plastic, and the like.

At Muuto, we want our furniture to enhance your surroundings, while at the same time, create healthier indoor climates. That's why we go to great lengths to have our furniture tested to secure low emitting products. So far, the vast majority of our furniture collection is VOC tested.

Reasons to feel reassured

Certificates & Eco labels

There are numerous types of labels and certificates, and we have chosen the ones most relevant to you — and our portfolio of products. Several of our designs have the following certifications and labels:

The EU Ecolabel Certification: This renowned certification is well-respected worldwide as it identifies products having a reduced environmental impact spanning a product's total lifecycle — from raw material to disposal.

Declare Red List free label: A platform based on transparency that lets you see the origins and lifecycle of a product.

GreenTag Level C-certification: Recognized worldwide as a trusted, independent eco-label certification, the Global GreenTag was established to empower you, as a consumer, to confidently choose designs founded with sustainable initiatives within a wide variety of parameters — from minimizing hazardous substances, wood from sustainable forestry and durability.

FSC™-certification: The Forest Stewardship Council™ (FSC) aims to ensure that forests are managed in an environmentally responsible manner that preserves the natural surroundings while supporting the local community. Look for our FSC™-certified products.



The mark of responsible forestry



Declare.



Explore a selection of certificates for each product in the Collection Overview. For a full overview, see our Product Fact Sheets.

Our work internally

Our operation

We always consider how our decisions will affect the lives of those around us. That also includes evaluating our internal operations.

Our Danish HQ, offices and warehouses are running on 100% renewable energy through green certificates. A move that lowers our overall carbon footprint. It's an initiative we are in the process of incorporating in all our Muuto showrooms and stores around the world.

The Danish company Målbar offers a screening tool that lets us measure our CO₂e-emission per product. By tracking a product's components and their origins it's possible to calculate the total CO₂e-emission of a product. By using Målbar for tracking emissions we are able to learn and improve our operations by taking informed and well-considered choices about the products we bring to the market.

A shared responsibility

Our suppliers

As we aim to take responsibility for our operations, we expect and demand the same from our suppliers. In striving to ensure that our designs are safely produced by skilled workers who operate under safe and healthy conditions, we have all our manufacturers sign our Code of Conduct.

As a member of the United Nations Global Compact, our Code of Conduct is aligned with the UN Global Compact principles within human rights, labour, environment, and anti-corruption. For us, it's essential that our suppliers share the same mindset when it comes to socially responsible practices.

Our path forward

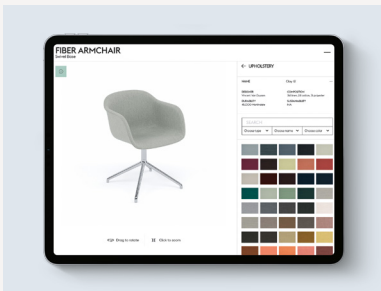
Our ambitions for the future reflect a humble yet committed approach to what lies ahead and how we get there. Learn more about our sustainable perspectives and explore the goals that continue to guide our work now and in the future at our Sustainability Site.

Discover more about
our sustainable perspectives



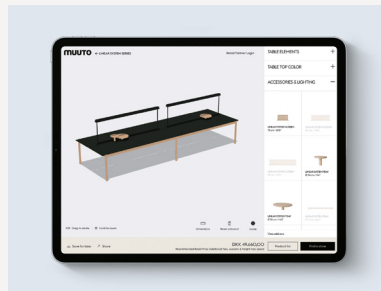
discover our profes— sional's

toolbox



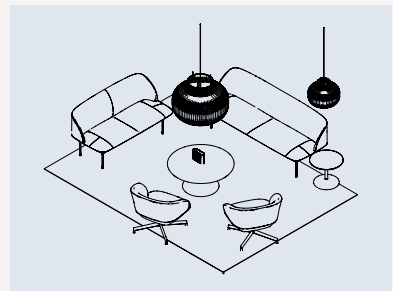
Product Configurator

Get creative — Use the Product Configurator to visualize the extensive possibilities of our collection, allowing you to tailor our designs to your project. Discover our vast selection of configurable designs, marked with a 'Configurable' label in the Collection Overview.



Product Planner

Endless possibilities — Get creative and explore the endless possibilities of our modular designs, configuring them to your exact aesthetic and spatial needs. With our Product Planner you can select from pre-designed configurations or create your own, save images for mood boards and easily share your configuration with colleagues.



Planning Ideas

Planning made easy — Get inspired and save time in the planning phase of your project by using the extensive selection of pre-designed Planning Ideas that you can import directly into your spatial planning program.

pCon.planner

Your space planning software — Our collection is available in pCon.planner. Find CAD files enriched with prices and relevant product information, enabling you to configure Muuto designs to the exact needs of your project as well as deliver accurate price quotations.

+1.500 Ready-To-Ship Options



Ready-To-Ship Collection

For speedy delivery — With our extensive Ready-To-Ship collection, many of our designs are available for immediate shipping in a broad selection of colors and upholsteries spanning across furniture, lighting and accessories.

Customize our design

Custom upholstery & colors — An extensive selection of Made-To-Order Options opens up over 100.000 possibilities of customization within our collection, allowing you to tailor specifically to the identity and needs of a project. If you are not able to find exactly what you are looking for, you have the option of providing your own upholstery.

For custom upholstery, we offer a 'Customer's Own Material Tool', containing a multitude of carefully tested upholstery, spanning our furniture collection, for easy navigation of approved upholstery options.

In addition, most furniture is available in custom colors upon request. Please find more information in our Price List.

Tests, Labels & Certificates

Get the full overview — At Muuto, we place the highest importance on creating high-quality products. To ensure this, we carry out extensive tests by independent institutes. As we are constantly making new tests and receiving new labels and certificates, our 'Test, Labels & Certificates Tool' allows you to search for the latest updates of test information obtained for our collection.

Downloads

Find your resources — Visit our Download site to find CAD files, Product Fact Sheets, product images and much more. Learn more about our products, materials and how to maintain our designs in the Product Fact Sheets and Price List.



collection

furni

ture



outdoor¹⁹⁶
lighting²⁰³
accessories²²⁴

The Fiber Chair brings a new perspective to the iconic shell chair through its innovative composite of wood fibers and 100% recycled plastic. The wood fibers blend into the surface for a matte finish, adding a soft, inviting touch. Though invisible to the eye from afar, the details of the wood fibers are revealed when viewing the design up close. The Fiber Chair Family is designed in a simple and sculptural form language for a slender chair on the outside—taking up little space in the room—while having a spacious inner, created for maximum comfort.

fiber chair



family

by Iskos-Berlin



The Fiber Chair Family includes many typologies, allowing you to combine conference chairs, armchairs, side chairs, bar and counter stools, stools, and lounge chairs in a wide range of bases, colors, and upholsteries throughout your project.



Soft Armchair

Wood Base, Tube Base, Swivel Base w. or w.o. Return, Swivel Base w. Return & Tilt, Swivel Base w. Castors, Swivel Base w. Tilt & Castors, Swivel Base w. Gas Lift, Tilt & Castors



Conference Armchair

Wood Base, Tube Base, Swivel Base w. or w.o. Return, Swivel Base w. Return & Tilt, Swivel Base w. Castors, Swivel Base w. Tilt & Castors, Swivel Base w. Gas Lift, Tilt & Castors



Armchair

Wood Base, Tube Base, Sled Base, Swivel Base w. or w.o. Return, Swivel Base w. Castors, Swivel Base w. Gas Lift & Castors



Side Chair

Wood Base, Tube Base, Sled Base, A-Base w. or w.o. Linking Device, Swivel Base w. or w.o. Return, Swivel Base w. Castors, Swivel Base w. Gas Lift & Castors



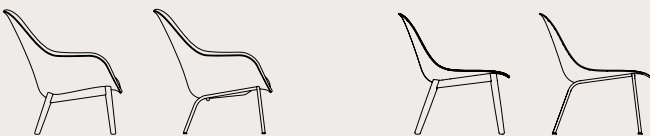
Bar Stool, Counter Stool & Stool

Wood Base



Bar Stool, Counter Stool & Stool

Tube Base



Lounge Armchair
Wood Base, Tube Base

Lounge Chair
Wood Base, Tube Base

fiber soft armchair

by Iskos-Berlin

A sculptural yet distinctly ergonomic seat makes the Fiber Soft Armchair ideal for anywhere we spend extended time seated. Its interior shell, made of 100% recycled plastic, is clad with soft wadding and upholstery to elevate a supreme sense of ease and embrace. The spacious, ultra-soft seat and smooth curves of the Fiber Soft Armchair provide maximum comfort in public spaces and the home.



Wood Base

Materials

Shell from 100% recycled plastic mixed with strength-improving additives. The recycled plastic comes from post-consumer waste. Seat, back and armrest is clad with multiple layers of foam and wadding and finished with textile, imitation leather or leather upholstery. Wood base in FSC™-certified oak with water-based lacquer. For Stained Dark Brown versions slight color variation can occur. Plastic glides.

Certificates

Strength & Stability: EN 1022, EN 16139-L2, BIFMA X5.4.

Eco Labels & Safety: VOC CDPH 01350* and BIFMA X7.1*, FSC™, Crib 5 upon request.

Warranty: 10 year

Options

Felt glides

Color Options & Codes

Upholstery: Textile, imitation leather, or leather. See the wide selection in our digital Product Configurator and visit our Price List for a full overview.

Base: Oak, Stained Dark Brown, Anthracite Black (RAL 7021), Grey (RAL 7030).

Ready-To-Ship

Ecriture 240 / Oak



Dimensions

Total height:	77,5 cm / 30.5"
Total width:	63,5 cm / 25"
Total depth:	60,5 cm / 23.8"
Armrest height:	67,2 cm / 26.5"
Seat height:	49 cm / 19.3"
Seat depth:	49,3 cm / 19.4"
Seat width:	51 cm / 20"



Tube Base

Materials

Shell from 100% recycled plastic mixed with strength-improving additives. The recycled plastic comes from post-consumer waste. Seat, back and armrest is clad with multiple layers of foam and wadding and finished with textile, imitation leather or leather upholstery. Tube base in powder coated steel. Plastic glides.

Certificates & Warranty

Strength & Stability: EN 1022, EN 16139-L2, BIFMA X5.4.

Eco Labels & Safety: VOC CDPH 01350* and BIFMA X7.1*, Crib 5 upon request.

Warranty: 10 years

Options

Felt glides.

Color Options & Codes

Upholstery: Textile, imitation leather, or leather. See the wide selection in our digital Product Configurator and visit our Price List for a full overview.

Base: Anthracite Black (RAL 7021), Grey (RAL 7030).

Ready-To-Ship

Ecriture 240 / Grey



Dimensions

Total height:	77,5 cm / 30.5"
Total width:	63,5 cm / 25"
Total depth:	60,5 cm / 23.8"
Armrest height:	67,2 cm / 26.5"
Seat height:	49 cm / 19.3"
Seat depth:	49,3 cm / 19.4"
Seat width:	51 cm / 20"

*Valid for a large selection of Kvadrat upholstery. Refine and Easy/leather.



W 63,5 cm / 25"



D 60,5 cm / 23.8"

H 77,5 cm / 30.5"
SH 49 cm / 19.3"



W 63,5 cm / 25"



D 60,5 cm / 23.8"

H 77,5 cm / 30.5"
SH 49 cm / 19.3"



Swivel Base w. or w.o. return

Materials

Shell from 100% recycled plastic mixed with strength-improving additives. The recycled plastic comes from post-consumer waste. Seat, back and armrest is clad with multiple layers of foam and wadding and finished with textile, imitation leather or leather upholstery. Swivel base and cylinder in powder coated aluminum. Plastic glides.

Certificates

Strength & Stability: EN 1022, EN 16139-L2, BIFMA X5.4.

Eco Labels & Safety: VOC CDPH 01350* and BIFMA X7.1*, Crib 5 upon request.

Warranty: 10 year

Options

Felt glides

Color Options & Codes

Upholstery: Textile, imitation leather, or leather. See the wide selection in our digital Product Configurator and visit our Price List for a full overview.

Base: Anthracite Black (RAL 7021), Grey (RAL 7030).

Ready-To-Ship

Ecriture 240 / Grey*



*Valid for Swivel Base w.o. return

Dimensions

Total height:	77,5 cm / 30.5"
Total width:	63,5 cm / 25"
Total depth:	60,5 cm / 23.8"
Armrest height:	67,2 cm / 26.5"
Seat height:	49 cm / 19.3"
Seat depth:	49,3 cm / 19.4"
Seat width:	51 cm / 20"



Swivel Base w. return & tilt

Materials

Shell from 100% recycled plastic mixed with strength-improving additives. The recycled plastic comes from post-consumer waste. Seat, back and armrest is clad with multiple layers of foam and wadding and finished with textile, imitation leather or leather upholstery. Swivel base and cylinder in powder coated aluminum. Plastic glides.

Certificates & Warranty

Strength & Stability: EN 1022, EN 16139-L2, BIFMA X5.4.

Eco Labels & Safety: VOC CDPH 01350* and BIFMA X7.1*, Crib 5 upon request.

Warranty: 10 years

Options

Felt glides.

Color Options & Codes

Upholstery: Textile, imitation leather, or leather. See the wide selection in our digital Product Configurator and visit our Price List for a full overview.

Base: Anthracite Black (RAL 7021), Grey (RAL 7030).

Dimensions

Total height:	77,5 cm / 30.5"
Total width:	63,5 cm / 25"
Total depth:	60,5 cm / 23.8"
Armrest height:	67,2 cm / 26.5"
Seat height:	49 cm / 19.3"
Seat depth:	49,3 cm / 19.4"
Seat width:	51 cm / 20"



W 63,5 cm / 25"



D 60,5 cm / 23.8"

H 77,5 cm / 30.5"
SH 49 cm / 19.3"



W 63,5 cm / 25"



D 60,5 cm / 23.8"

H 77,5 cm / 30.5"
SH 49 cm / 19.3"

*Valid for a large selection of Kvadrat upholstery, Refine and Easy leather.

fiber soft armchair

by Iskos-Berlin



Configurable

Swivel Base w. castors

Materials

Shell from 100% recycled plastic mixed with strength-improving additives. The recycled plastic comes from post-consumer waste. Seat, back and armrest is clad with multiple layers of foam and wadding and finished with textile, imitation leather or leather upholstery. Swivel base and cylinder in powder coated aluminum. Castors.

Certificates & Warranty

Strength & Stability: EN 1022, EN 16139-L2, BIFMA X5.4.

Eco Labels & Safety: VOC CDPH 01350* and BIFMA X7.1*, Crib 5 upon request.

Warranty: 10 years

Color Options & Codes

Upholstery: Textile, imitation leather, or leather. See the wide selection in our digital Product Configurator and visit our Price List for a full overview.

Base: Anthracite Black (RAL 7021), Grey (RAL 7030) with Black castors.

Dimensions

Total height:	77,5 cm / 30.5"
Total width:	63,5 cm / 25"
Total depth:	60,5 cm / 23.8"
Armrest height:	67,2 cm / 26.5"
Seat height:	49 cm / 19.3"
Seat depth:	49,3 cm / 19.4"
Seat width:	51 cm / 20"



Configurable

Swivel Base w. tilt & castors

Materials

Shell from 100% recycled plastic mixed with strength-improving additives. The recycled plastic comes from post-consumer waste. Seat, back and armrest is clad with multiple layers of foam and wadding and finished with textile, imitation leather or leather upholstery. Swivel base and cylinder in powder coated aluminum. Castors.

Certificates

Strength & Stability: EN 1022, EN 16139-L2, BIFMA X5.4.

Eco Labels & Safety: VOC CDPH 01350* and BIFMA X7.1*, Crib 5 upon request.

Warranty: 10 year

Options

Felt glides

Color Options & Codes

Upholstery: Textile, imitation leather, or leather. See the wide selection in our digital Product Configurator and visit our Price List for a full overview.

Base: Anthracite Black (RAL 7021), Grey (RAL 7030) with Black castors.

Dimensions

Total height:	77,5 cm / 30.5"
Total width:	63,5 cm / 25"
Total depth:	60,5 cm / 23.8"
Armrest height:	67,2 cm / 26.5"
Seat height:	49 cm / 19.3"
Seat depth:	49,3 cm / 19.4"
Seat width:	51 cm / 20"



Configurable

Swivel Base w. gas lift, tilt & castors

Materials

Shell from 100% recycled plastic mixed with strength-improving additives. The recycled plastic comes from post-consumer waste. Seat, back and armrest is clad with multiple layers of foam and wadding and finished with textile, imitation leather or leather upholstery. 5-star swivel base and cylinder in powder coated aluminum. Pressurized gas lift cylinder. Castors.

Certificates & Warranty

Strength & Stability: EN 1022, EN 16139-L2, BIFMA X5.4.

Eco Labels & Safety: VOC CDPH 01350* and BIFMA X7.1*, Crib 5 upon request.

Warranty: 10 years

Options

Felt glides

Color Options & Codes

Upholstery: Textile, imitation leather, or leather. See the wide selection in our digital Product Configurator and visit our Price List for a full overview.

Base: Anthracite Black (RAL 7021), Grey (RAL 7030) with Black castors.

Dimensions

Total height:	73-85 cm / 28.9-33.5"
Total width:	63,5 cm / 25"
Total depth:	68 cm / 26.8"
Armrest height:	63-75 cm / 24.8-29.5"
Seat height:	45-57 cm / 17.6-22.3"
Seat depth:	49,3 cm / 19.4"
Seat width:	51 cm / 20"

*Valid for a large selection of Kvadrat upholstery. Refine and Easy leather.



W 63,5 cm / 25"



D 60,5 cm / 23.8"

H 77,5 cm / 30.5"
SH 49 cm / 19.3"



W 63,5 cm / 25"



D 60,5 cm / 23.8"

H 77,5 cm / 30.5"
SH 49 cm / 19.3"



W 63,5 cm / 25"



D 60,5 cm / 23.8"

H 73-85 cm / 28.9-33.5"
SH 45-57 cm / 17.6-22.3"

fiber conference armchair

by Iskos-Berlin

A sculptural yet distinctly ergonomic seat makes the Fiber Conference Armchair ideal anywhere we spend an extended time seated. Its interior shell is made of 100% recycled plastic, while its spacious seat and embracing curves are fully upholstered with a soft fixed cushion, providing maximum comfort while dining, in the meeting or conference room or at the home office.



Wood Base

Materials

Shell from 100% recycled plastic mixed with strength-improving additives. The recycled plastic comes from post-consumer waste. Fully upholstered in textile, imitation leather, or leather. Wood base in FSC™-certified oak with water-based lacquer. For Stained Dark Brown versions slight color variation can occur. Plastic glides.

Certificates & Warranty

Strength & Stability: EN 16139 - L2, BIFMA X5.4.

Eco Labels & Safety: VOC CDPH 01350* and BIFMA X7.1*, FSC™, Crib 5 upon request.

Warranty: 10 years

Options

Felt glides.

Color Options & Codes

Upholstery: Textile, imitation leather, or leather. See the wide selection in our digital Product Configurator and visit our Price List for a full overview.

Base: Anthracite Black (RAL 7021), Grey (RAL 7030), Oak, Stained Dark Brown.

Ready-To-Ship Options

Upholstery / Base

Remix 133 / Grey

Configurable



Tube Base

Materials

Shell from 100% recycled plastic mixed with strength-improving additives. The recycled plastic comes from post-consumer waste. Fully upholstered in textile, imitation leather, or leather. Tube base in powder coated steel. Plastic glides.

Certificates & Warranty

Strength & Stability: EN 16139 - L2, BIFMA X5.4.

Eco Labels & Safety: VOC CDPH 01350* and BIFMA X7.1*, Crib 5 upon request.

Warranty: 10 years

Options

Felt glides.

Color Options & Codes

Upholstery: Textile, imitation leather, or leather. See the wide selection in our digital Product Configurator and visit our Price List for a full overview.

Base: Anthracite Black (RAL 7021), Grey (RAL 7030).

Dimensions

Total height:	77,5 cm / 30.5"
Total width:	63,5 cm / 25"
Total depth:	60,5 cm / 23.8"
Armrest height:	67,2 cm / 26.5"
Seat height:	49 cm / 19.3"
Seat depth:	49,3 cm / 19.4"
Seat width:	51 cm / 20"

Dimensions

Total height:	77,5 cm / 30.5"
Total width:	63,5 cm / 25"
Total depth:	60,5 cm / 23.8"
Armrest height:	67,2 cm / 26.5"
Seat height:	49 cm / 19.3"
Seat depth:	49,3 cm / 19.4"
Seat width:	51 cm / 20"



W 63,5 cm / 25"



D 60,5 cm / 23.8"

H 77,5 cm / 30.5"
SH 49 cm / 19.3"



W 63,5 cm / 25"



D 60,5 cm / 23.8"

H 77,5 cm / 30.5"
SH 49 cm / 19.3"

fiber conference armchair

by Iskos-Berlin

98

seating



Configurable

Swivel Base w. or w.o. return

Materials

Shell from 100% recycled plastic mixed with strength-improving additives. The recycled plastic comes from post-consumer waste. Fully upholstered in textile, imitation leather, or leather. Swivel base and cylinder in powder coated aluminum. Plastic glides.

Certificates & Warranty

Strength & Stability: EN 16139 - L2, BIFMA X5.4.
Eco Labels & Safety: VOC CDPH 01350* and BIFMA X7.1*, Crib 5 upon request.
Warranty: 10 years

Options

Felt glides.

Color Options & Codes

Upholstery: Textile, imitation leather, or leather. See the wide selection in our digital Product Configurator and visit our Price List for a full overview.
Base: Anthracite Black (RAL 7021), Grey (RAL 7030).

Ready-To-Ship Options

Upholstery / Base

Remix 133 / Grey*



*Valid for Swivel Base w.o. return

Dimensions

Total height:	77,5 cm / 30.5"
Total width:	63,5 cm / 25"
Total depth:	60,5 cm / 23.8"
Armrest height:	67,2 cm / 26.5"
Seat height:	49 cm / 19.3"
Seat depth:	49,3 cm / 19.4"
Seat width:	51 cm / 20"



Configurable

Swivel Base w. return & tilt

Materials

Shell from 100% recycled plastic mixed with strength-improving additives. The recycled plastic comes from post-consumer waste. Fully upholstered in textile, imitation leather, or leather. Swivel base and cylinder in powder coated aluminum. Plastic glides.

Certificates & Warranty

Strength & Stability: EN 16139 - L2, BIFMA X5.4.
Eco Labels & Safety: VOC CDPH 01350* and BIFMA X7.1*, Crib 5 upon request.
Warranty: 10 years

Options

Felt glides.

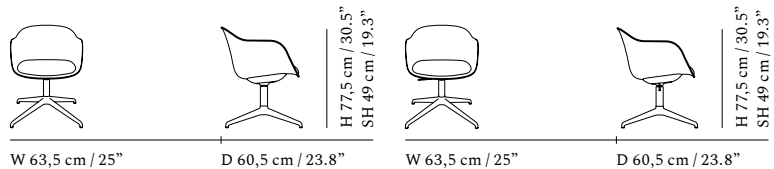
Color Options & Codes

Upholstery: Textile, imitation leather, or leather. See the wide selection in our digital Product Configurator and visit our Price List for a full overview.
Base: Anthracite Black (RAL 7021), Grey (RAL 7030).

Dimensions

Total height:	77,5 cm / 30.5"
Total width:	63,5 cm / 25"
Total depth:	60,5 cm / 23.8"
Armrest height:	67,2 cm / 26.5"
Seat height:	49 cm / 19.3"
Seat depth:	49,3 cm / 19.4"
Seat width:	51 cm / 20"

*Valid for a large selection of Kvadrat upholstery. Refine and Easy/leather.





Swivel Base w. castors

Materials

Shell from 100% recycled plastic mixed with strength-improving additives. The recycled plastic comes from post-consumer waste. Fully upholstered in textile, imitation leather, or leather. Swivel base and cylinder in powder coated aluminum. Castors.

Certificates & Warranty

Strength & Stability: EN 16139 - L2, BIFMA X5.4.
Eco Labels & Safety: VOC CDPH 01350* and BIFMA X7.1*, Crib 5 upon request.
Warranty: 10 years

Color Options & Codes

Upholstery: Textile, imitation leather, or leather. See the wide selection in our digital Product Configurator and visit our Price List for a full overview.
Base: Anthracite Black (RAL 7021), Grey (RAL 7030) with Black castors.

Dimensions

Total height:	77,5 cm / 30.5"
Total width:	63,5 cm / 25"
Total depth:	60,5 cm / 23.8"
Armrest height:	67,2 cm / 26.5"
Seat height:	49 cm / 19.3"
Seat depth:	49,3 cm / 19.4"
Seat width:	51 cm / 20"



Swivel Base w. tilt & castors

Materials

Shell from 100% recycled plastic mixed with strength-improving additives. The recycled plastic comes from post-consumer waste. Fully upholstered in textile, imitation leather, or leather. Swivel base and cylinder in powder coated aluminum. Castors.

Certificates & Warranty

Strength & Stability: EN 16139 - L2, BIFMA X5.4.
Eco Labels & Safety: VOC CDPH 01350* and BIFMA X7.1*, Crib 5 upon request.
Warranty: 10 years

Color Options & Codes

Upholstery: Textile, imitation leather, or leather. See the wide selection in our digital Product Configurator and visit our Price List for a full overview.
Base: Anthracite Black (RAL 7021), Grey (RAL 7030) with Black castors.

Dimensions

Total height:	77,5 cm / 30.5"
Total width:	63,5 cm / 25"
Total depth:	60,5 cm / 23.8"
Armrest height:	67,2 cm / 26.5"
Seat height:	49 cm / 19.3"
Seat depth:	49,3 cm / 19.4"
Seat width:	51 cm / 20"



Swivel Base w. gas lift, tilt & castors

Materials

Shell from 100% recycled plastic mixed with strength-improving additives. The recycled plastic comes from post-consumer waste. Fully upholstered in textile, imitation leather, or leather. 5-star swivel base and cylinder in powder coated aluminum. Pressurized gas lift cylinder. Castors.

Certificates & Warranty

Strength & Stability: EN 16139 - L2, BIFMA X5.4.
Eco Labels & Safety: VOC CDPH 01350* and BIFMA X7.1*, Crib 5 upon request.
Warranty: 10 years

Color Options & Codes

Upholstery: Textile, imitation leather, or leather. See the wide selection in our digital Product Configurator and visit our Price List for a full overview.
Base: Anthracite Black (RAL 7021), Grey (RAL 7030) with Black castors.

Dimensions

Total height:	73-85 cm / 28.9-33.5"
Total width:	63,5 cm / 25"
Total depth:	68 cm / 26.8"
Armrest height:	63-75 cm / 24.8-29.5"
Seat height:	45-57 cm / 17.6-22.3"
Seat depth:	49,3 cm / 19.4"
Seat width:	51 cm / 20"

*Valid for a large selection of Kvadrat upholstery, Refine and Easy leather.



W 63,5 cm / 25"



D 60,5 cm / 23.8"

H 77,5 cm / 30.5"
SH 49 cm / 19.3"



W 63,5 cm / 25"



D 60,5 cm / 23.8"

H 77,5 cm / 30.5"
SH 49 cm / 19.3"



W 63,5 cm / 25"



D 68 cm / 26.8"

H 73-85 cm / 28.9-33.5"
SH 45-57 cm / 17.6-22.3"

fiber armchair

by Iskos-Berlin

The Fiber Armchair is made from an innovative composite of wood and plastic fibers for a deep, matte surface and soft touch. The design has a slender form that doesn't take up much space while having an embracing, spacious seat for maximum comfort. Due to its wide range of shell and base options, Fiber Armchair meets the diverse needs of both office and hospitality settings.

100

seating



Configurable

Wood Base

— Shell

Materials

Shell from 100% recycled plastic reinforced with strength-improving additives and mixed with up to 25% FSC™-certified wood fibers. Due to the partly natural material of the shell, slight color variations can occur. Wood base in FSC™-certified solid oak with water-based lacquer. For Stained Dark Brown versions slight color variation can occur. Plastic glides.

Certificates & Warranty

Strength & Stability: EN 16139 - L2, EN 1022, BIFMA X5.4, BIFMA X5.1 **Eco Labels & Safety:** Declare Redlist approved, GreenTag Level C, VOC CDPH 01350 and BIFMA X7.1, FSC™, EU Ecolabel.

Warranty: 10 years

Options

Felt glides. Seat Pad.

Color Options & Codes

Shell: Natural White (close to RAL 9010), Black (RAL 7021), Dusty Green (RAL 7033), Grey (RAL 7030), Ochre (close to NCS S3040-Y20R). **Base:** Oak, Stained Dark Brown, Anthracite Black (RAL 7021), Dusty Green (RAL 7033), Grey (RAL 7030).

Ready-To-Ship Options

Shell / Base

Natural White / Oak	
Black / Anthracite Black	
Dusty Green / Dusty Green	
Grey / Grey	
Ochre / Oak	
Black / Stained Dark Brown	

Dimensions

Total height:	77 cm / 30.3"
Total width:	54,5 cm / 21.5"
Total depth:	56 cm / 22"
Armrest height:	68 cm / 26.8"
Armrest depth:	34 cm / 13.5"
Seat height:	46 cm / 18.1"
Seat depth:	46 cm / 18.1"
Seat width:	46 cm / 18.1"



W 54,5 cm / 21.5"



Configurable

Wood Base

— Front Upholstery

Materials

Shell from 100% recycled plastic reinforced with strength-improving additives and mixed with up to 25% FSC™-certified wood fibers. Due to the partly natural material of the shell, slight color variations can occur. Front upholstered shell with textile, imitation leather, or leather. Wood base in FSC™-certified solid oak with water-based lacquer. For Stained Dark Brown versions slight color variation can occur. Plastic glides.

Certificates & Warranty

Strength & Stability: EN 16139 - L2, EN 1022, BIFMA X5.4, BIFMA X5.1. **Eco Labels & Safety:** GreenTag Level C**, VOC CDPH 01350* and BIFMA X7.1*, FSC™, Crib 5 upon request.

Warranty: 10 years

Options

Felt glides.

Color Options & Codes

Upholstery: Textile, imitation leather, or leather. See the wide selection in our digital Product Configurator and visit our Price List for a full overview. **Shell:** Natural White (close to RAL 9010), Black (RAL 7021), Dusty Green (RAL 7033), Grey (RAL 7030), Ochre (close to NCS S3040-Y20R). **Base:** Oak, Stained Dark Brown, Anthracite Black (RAL 7021), Dusty Green (RAL 7033), Grey (RAL 7030).

Dimensions

Total height:	77 cm / 30.3"
Total width:	54,5 cm / 21.5"
Total depth:	56 cm / 22"
Armrest height:	68 cm / 26.8"
Armrest depth:	34 cm / 13.5"
Seat height:	46 cm / 18.1"
Seat depth:	46 cm / 18.1"
Seat width:	46 cm / 18.1"



D 56 cm / 22"



Configurable

Wood Base

— Full Upholstery

Materials

Shell from 100% recycled plastic reinforced with strength-improving additives and mixed with up to 25% FSC™-certified wood fibers. Fully upholstered shell with textile, imitation leather, or leather. Wood base in FSC™-certified solid oak with water-based lacquer. For Stained Dark Brown versions slight color variation can occur. Plastic glides.

Certificates & Warranty

Strength & Stability: EN 16139 - L2, EN 1022, BIFMA X5.4, BIFMA X5.1. **Eco Labels & Safety:** GreenTag Level C**, VOC CDPH 01350* and BIFMA X7.1*, FSC™, Crib 5 upon request.

Warranty: 10 years

Options

Felt glides.

Color Options & Codes

Upholstery: Textile, imitation leather, or leather. See the wide selection in our digital Product Configurator and visit our Price List for a full overview. **Base:** Oak, Stained Dark Brown, Anthracite Black (RAL 7021), Dusty Green (RAL 7033), Grey (RAL 7030).

Ready-To-Ship Options

Upholstery / Base

Refine Leather Cognac / Oak	
-----------------------------	--

Dimensions

Total height:	77 cm / 30.3"
Total width:	54,5 cm / 21.5"
Total depth:	56 cm / 22"
Armrest height:	68 cm / 26.8"
Armrest depth:	34 cm / 13.5"
Seat height:	46 cm / 18.1"
Seat depth:	46 cm / 18.1"
Seat width:	46 cm / 18.1"

*Valid for a large selection of Kvadrat upholstery, Refine and Easy leather.
**Valid for a large selection of Kvadrat upholstery.

H 77 cm / 30.3"
SH 46 cm / 18.1"



Tube Base
— Shell

Materials

Shell from 100% recycled plastic reinforced with strength-improving additives and mixed with up to 25% FSC™-certified wood fibers. Due to the partly natural material of the shell, slight color variations can occur. Tube base in powder coated steel. Plastic glides.

Certificates & Warranty

Strength & Stability: EN 16139 - L2, EN 1022, BIFMA X5.4. **Eco Labels & Safety:** Declare Red list approved, GreenTag Level C, VOC CDPH 01350 and BIFMA X7.1, FSC™, EU Ecolabel.

Warranty: 10 years

Options











Felt glides. Seat Pad.

Color Options & Codes

Shell: Natural White (close to RAL 9010), Black (RAL 7021), Dusty Green (RAL 7033), Grey (RAL 7030), Ochre (close to NCS S3040-Y20R) **Base:** White (RAL 9010), Anthracite Black (RAL 7021), Dusty Green (RAL 7033), Grey (RAL 7030), Chrome.

Ready-To-Ship Options

Shell / Base

Natural White / White	 
Black / Anthracite Black	 
Dusty Green / Dusty Green	 
Grey / Grey	 
Ochre / Anthracite Black	 

Dimensions

Total height:	77 cm / 30.3"
Total width:	54,5 cm / 21.5"
Total depth:	56 cm / 22"
Armrest height:	68 cm / 26.8"
Armrest depth:	34 cm / 13.5"
Seat height:	46 cm / 18.1"
Seat depth:	46 cm / 18.1"
Seat width:	46 cm / 18.1"



W 54,5 cm / 21.5"



Tube Base
— Front Upholstery

Materials

Shell from 100% recycled plastic reinforced with strength-improving additives and mixed with up to 25% FSC™-certified wood fibers. Due to the partly natural material of the shell, slight color variations can occur. Front upholstered shell with textile, imitation leather, or leather. Tube base in powder coated steel. Plastic glides.

Certificates & Warranty

Strength & Stability: EN 16139 - L2, EN 1022, BIFMA X5.4. **Eco Labels & Safety:** GreenTag Level C**, VOC CDPH 01350* and BIFMA X7.1*, FSC™, Crib 5 upon request.

Warranty: 10 years

Options

Felt glides.

Color Options & Codes

Upholstery: Textile, imitation leather, or leather. See the wide selection in our digital Product Configurator and visit our Price List for a full overview. **Shell:** Natural White (close to RAL 9010), Black (RAL 7021), Dusty Green (RAL 7033), Grey (RAL 7030), Ochre (close to NCS S3040-Y20R) **Base:** White (RAL 9010), Anthracite Black (RAL 7021), Dusty Green (RAL 7033), Grey (RAL 7030), Chrome.

Dimensions

Total height:	77 cm / 30.3"
Total width:	54,5 cm / 21.5"
Total depth:	56 cm / 22"
Armrest height:	68 cm / 26.8"
Armrest depth:	34 cm / 13.5"
Seat height:	46 cm / 18.1"
Seat depth:	46 cm / 18.1"
Seat width:	46 cm / 18.1"



D 56 cm / 22"



Tube Base
— Full Upholstery

Materials

Shell from 100% recycled plastic reinforced with strength-improving additives and mixed with up to 25% FSC™-certified wood fibers. Fully upholstered shell with textile, imitation leather, or leather. Tube base in powder coated steel. Plastic glides.

Certificates & Warranty

Strength & Stability: EN 16139 - L2, EN 1022, BIFMA X5.4. **Eco Labels & Safety:** GreenTag Level C**, VOC CDPH 01350* and BIFMA X7.1*, FSC™, Crib 5 upon request.

Warranty: 10 years

Options



Felt glides.

Color Options & Codes

Upholstery: Textile, imitation leather, or leather. See the wide selection in our digital Product Configurator and visit our Price List for a full overview. **Base:** White (RAL 9010), Anthracite Black (RAL 7021), Dusty Green (RAL 7033), Grey (RAL 7030), Chrome.

Ready-To-Ship Options

Upholstery / Base

Refine Leather Cognac / Anthracite Black  

Dimensions

Total height:	77 cm / 30.3"
Total width:	54,5 cm / 21.5"
Total depth:	56 cm / 22"
Armrest height:	68 cm / 26.8"
Armrest depth:	34 cm / 13.5"
Seat height:	46 cm / 18.1"
Seat depth:	46 cm / 18.1"
Seat width:	46 cm / 18.1"

H 77 cm / 30.3"
SH 46 cm / 18.1"

fiber armchair

by Iskos-Berlin

1o2

seating



Configurable

Sled Base

— Shell

Materials

Shell from 100% recycled plastic reinforced with strength-improving additives and mixed with up to 25% FSC™-certified wood fibers. Due to the partly natural material of the shell, slight color variations can occur. Sled Base in powder coated steel. Plastic glides.

Certificates & Warranty

Strength & Stability: EN 16139 - L2, EN 1022, BIFMA X5.4. **Eco Labels & Safety:** Declare Red list approved, GreenTag Level C, VOC CDPH 01350 and BIFMA X7.1, FSC™, EU Ecolabel. **Warranty:** 10 years

Options

Felt glides. Seat Pad.

Color Options & Codes

Shell: Natural White (close to RAL 9010), Black (RAL 7021), Dusty Green (RAL 7033), Grey (RAL 7030), Ochre (close to NCS S3040-Y20R).

Base: White (RAL 9010), Anthracite Black (RAL 7021), Dusty Green (RAL 7033), Grey (RAL 7030).

Dimensions

Total height:	77 cm / 30.3"
Total width:	54,5 cm / 21.5"
Total depth:	55 cm / 21.75"
Armrest height:	68 cm / 26.8"
Armrest depth:	34 cm / 13.5"
Seat height:	46 cm / 18.1"
Seat depth:	46 cm / 18.1"
Seat width:	46 cm / 18.1"



Configurable

Sled Base

— Front Upholstery

Materials

Shell from 100% recycled plastic reinforced with strength-improving additives and mixed with up to 25% FSC™-certified wood fibers. Due to the partly natural material of the shell, slight color variations can occur. Front upholstered shell with textile, imitation leather, or leather. Sled Base in powder coated steel. Plastic glides.

Certificates & Warranty

Strength & Stability: EN 16139 - L2, EN 1022, BIFMA X5.4. **Eco Labels & Safety:** GreenTag Level C**, VOC CDPH 01350* and BIFMA X7.1*, FSC™, Crib 5 upon request. **Warranty:** 10 years

Options

Felt glides.

Color Options & Codes

Upholstery: Textile, imitation leather, or leather. See the wide selection in our digital Product Configurator and visit our Price List for a full overview.

Shell: Natural White (close to RAL 9010), Black (RAL 7021), Dusty Green (RAL 7033), Grey (RAL 7030), Ochre (close to NCS S3040-Y20R). **Base:** White (RAL 9010), Anthracite Black (RAL 7021), Dusty Green (RAL 7033), Grey (RAL 7030).

Dimensions

Total height:	77 cm / 30.3"
Total width:	54,5 cm / 21.5"
Total depth:	55 cm / 21.75"
Armrest height:	68 cm / 26.8"
Armrest depth:	34 cm / 13.5"
Seat height:	46 cm / 18.1"
Seat depth:	46 cm / 18.1"
Seat width:	46 cm / 18.1"



Configurable

Sled Base

— Full Upholstery

Materials

Shell from 100% recycled plastic reinforced with strength-improving additives and mixed with up to 25% FSC™-certified wood fibers. Fully upholstered shell with textile, imitation leather, or leather. Sled Base in powder coated steel. Plastic glides.

Certificates & Warranty

Strength & Stability: EN 16139 - L2, EN 1022, BIFMA X5.4. **Eco Labels & Safety:** GreenTag Level C**, VOC CDPH 01350* and BIFMA X7.1*, FSC™, Crib 5 upon request. **Warranty:** 10 years

Options

Felt glides.

Color Options & Codes

Upholstery: Textile, imitation leather, or leather. See the wide selection in our digital Product Configurator and visit our Price List for a full overview.

Shell: Natural White (close to RAL 9010), Black (RAL 7021), Dusty Green (RAL 7033), Grey (RAL 7030), Ochre (close to NCS S3040-Y20R). **Base:** White (RAL 9010), Anthracite Black (RAL 7021), Dusty Green (RAL 7033), Grey (RAL 7030).

Dimensions

Total height:	77 cm / 30.3"
Total width:	54,5 cm / 21.5"
Total depth:	55 cm / 21.75"
Armrest height:	68 cm / 26.8"
Armrest depth:	34 cm / 13.5"
Seat height:	46 cm / 18.1"
Seat depth:	46 cm / 18.1"
Seat width:	46 cm / 18.1"

*Valid for a large selection of Kvadrat upholstery, Refine and Easy leather.
**Valid for a large selection of Kvadrat upholstery.



W 54,5 cm / 21.5"



D 55 cm / 21.75"

H 77 cm / 30.3"
SH 46 cm / 18.1"



Swivel Base w. or w.o. return
— Shell

Materials

Shell from 100% recycled plastic reinforced with strength-improving additives and mixed with up to 25% FSC™-certified wood fibers. Due to the partly natural material of the shell, slight color variations can occur. Swivel base and cylinder in die casted aluminum. Plastic glides.

Certificates & Warranty

Strength & Stability: EN 16139 - L2, EN 1022, BIFMA X5.1**. **Eco Labels & Safety:** Declare Red list approved, GreenTag Level C, VOC CDPH 01350 and BIFMA X7.1, FSC™, EU Ecolabel.

Warranty: 10 years

Options

Felt glides. Seat Pad.

Color Options & Codes

Shell: Natural White (close to RAL 9010), Black (RAL 7021), Dusty Green (RAL 7033), Grey (RAL 7030), Ochre (close to NCS S3040-Y20R).

Base: White (RAL 9010), Anthracite Black (RAL 7021), Dusty Green (RAL 7033), Grey (RAL 7030), Polished Aluminum.

Dimensions

Total height:	77 cm / 30.3"
Total width:	54,5 cm / 21.5"
Total depth:	56 cm / 22"
Armrest height:	68 cm / 26.8"
Armrest depth:	34 cm / 13.5"
Seat height:	46 cm / 18.1"
Seat depth:	46 cm / 18.1"
Seat width:	46 cm / 18.1"



Swivel Base w. or w.o. return
— Front Upholstery

Materials

Shell from 100% recycled plastic reinforced with strength-improving additives and mixed with up to 25% FSC™-certified wood fibers. Due to the partly natural material of the shell, slight color variations can occur. Front upholstered shell with textile, imitation leather, or leather. Swivel base and cylinder in die casted aluminum. Plastic glides.

Certificates & Warranty

Strength & Stability: EN 1613 - L2, EN 1022, BIFMA X5.1**. **Eco Labels & Safety:** GreenTag Level C**, VOC CDPH 01350* and BIFMA X7.1*, FSC™, Crib 5 upon request.

Warranty: 10 years

Options

Felt glides.

Color Options & Codes

Upholstery: Textile, imitation leather, or leather. See the wide selection in our digital Product Configurator and visit our Price List for a full overview.

Shell: Natural White (close to RAL 9010), Black (RAL 7021), Dusty Green (RAL 7033), Grey (RAL 7030), Ochre (close to NCS S3040-Y20R) **Base:** White (RAL 9010), Anthracite Black (RAL 7021), Dusty Green (RAL 7033), Grey (RAL 7030), Polished Aluminum.

Dimensions

Total height:	77 cm / 30.3"
Total width:	54,5 cm / 21.5"
Total depth:	56 cm / 22"
Armrest height:	68 cm / 26.8"
Armrest depth:	34 cm / 13.5"
Seat height:	46 cm / 18.1"
Seat depth:	46 cm / 18.1"
Seat width:	46 cm / 18.1"



Swivel Base w. or w.o. return
— Full Upholstery

Materials

Shell from 100% recycled plastic reinforced with strength-improving additives and mixed with up to 25% FSC™-certified wood fibers. Fully upholstered shell with textile, imitation leather, or leather. Swivel base and cylinder in die casted aluminum. Plastic glides.

Certificates & Warranty

Strength & Stability: EN 1613 - L2, EN 1022, BIFMA X5.1**. **Eco Labels & Safety:** GreenTag Level C**, VOC CDPH 01350* and BIFMA X7.1*, FSC™, Crib 5 upon request.

Warranty: 10 years

Options

Felt glides.

Color Options & Codes

Upholstery: Textile, imitation leather, or leather. See the wide selection in our digital Product Configurator and visit our Price List for a full overview.

Base: White (RAL 9010), Anthracite Black (RAL 7021), Dusty Green (RAL 7033), Grey (RAL 7030), Polished Aluminum.

Ready-To-Ship Options

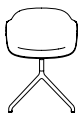
Upholstery / Base

Refine Leather Cognac / Anthracite Black*

*Valid for Swivel Base w.o. return

Dimensions

Total height:	77 cm / 30.3"
Total width:	54,5 cm / 21.5"
Total depth:	56 cm / 22"
Armrest height:	68 cm / 26.8"
Armrest depth:	34 cm / 13.5"
Seat height:	46 cm / 18.1"
Seat depth:	46 cm / 18.1"
Seat width:	46 cm / 18.1"



W 54,5 cm / 21.5"



D 56 cm / 22"

H 77 cm / 30.3"
SH 46 cm / 18.1"

fiber armchair

by Iskos-Berlin

104

seating



Configurable

Swivel Base w. castors
— Shell

Materials

Shell from 100% recycled plastic reinforced with strength-improving additives and mixed with up to 25% FSC™-certified wood fibers. Due to the partly natural material of the shell, slight color variations can occur. Swivel base and cylinder in die casted aluminum. Castors.

Certificates & Warranty

Strength & Stability: EN 16139 - L2, EN 1022, BIFMA X5.1. **Eco Labels & Safety:** Declare Red list approved, GreenTag Level C, VOC CDPH 01350 and BIFMA X7.1, FSC™, EU Ecolabel.

Warranty: 10 years

Options

Seat Pad.

Color Options & Codes

Shell: Natural White (close to RAL 9010), Black (RAL 7021), Dusty Green (RAL 7033), Grey (RAL 7030), Ochre (close to NCS S3040-Y20R).

Base: Anthracite Black (RAL 7021), Dusty Green (RAL 7033), Grey (RAL 7030) and Polished Aluminum with Black castors. White (RAL 9010) with White castors.

Dimensions

Total height:	77 cm / 30.3"
Total width:	54,5 cm / 21.5"
Total depth:	56 cm / 22"
Armrest height:	68 cm / 26.8"
Armrest depth:	34 cm / 13.5"
Seat height:	46 cm / 18.1"
Seat depth:	46 cm / 18.1"
Seat width:	46 cm / 18.1"



Configurable

Swivel Base w. castors
— Front Upholstery

Materials

Shell from 100% recycled plastic reinforced with strength-improving additives and mixed with up to 25% FSC™-certified wood fibers. Due to the partly natural material of the shell, slight color variations can occur. Front upholstered shell with textile, imitation leather, or leather. Swivel base and cylinder in die casted aluminum. Castors.

Certificates & Warranty

Strength & Stability: EN 16139 - L2, EN 1022, BIFMA X5.1. **Eco Labels & Safety:** GreenTag Level C**, VOC CDPH 01350* and BIFMA X7.1*, FSC™, Crib 5 upon request.

Warranty: 10 years

Color Options & Codes

Upholstery: Textile, imitation leather, or leather. See the wide selection in our digital Product Configurator and visit our Price List for a full overview.

Shell: Natural White (close to RAL 9010), Black (RAL 7021), Dusty Green (RAL 7033), Grey (RAL 7030), Ochre (close to NCS S3040-Y20R). **Base:** Anthracite Black (RAL 7021), Dusty Green (RAL 7033), Grey (RAL 7030) and Polished Aluminum with Black castors. White (RAL 9010) with White castors.

Dimensions

Total height:	77 cm / 30.3"
Total width:	54,5 cm / 21.5"
Total depth:	56 cm / 22"
Armrest height:	68 cm / 26.8"
Armrest depth:	34 cm / 13.5"
Seat height:	46 cm / 18.1"
Seat depth:	46 cm / 18.1"
Seat width:	46 cm / 18.1"



Configurable

Swivel Base w. castors
— Full Upholstery

Materials

Shell from 100% recycled plastic reinforced with strength-improving additives and mixed with up to 25% FSC™-certified wood fibers. Fully upholstered shell with textile, imitation leather, or leather. Swivel base and cylinder in die casted aluminum. Castors.

Certificates & Warranty

Strength & Stability: EN 16139 - L2, EN 1022, BIFMA X5.1. **Eco Labels & Safety:** GreenTag Level C**, VOC CDPH 01350* and BIFMA X7.1*, FSC™, Crib 5 upon request.

Warranty: 10 years

Color Options & Codes

Upholstery: Textile, imitation leather, or leather. See the wide selection in our digital Product Configurator and visit our Price List for a full overview.

Base: Anthracite Black (RAL 7021), Dusty Green (RAL 7033), Grey (RAL 7030) and Polished Aluminum with Black castors. White (RAL 9010) with White castors.

Dimensions

Total height:	77 cm / 30.3"
Total width:	54,5 cm / 21.5"
Total depth:	56 cm / 22"
Armrest height:	68 cm / 26.8"
Armrest depth:	34 cm / 13.5"
Seat height:	46 cm / 18.1"
Seat depth:	46 cm / 18.1"
Seat width:	46 cm / 18.1"

*Valid for a large selection of Kvadrat upholstery, Refine and Easy leather.
**Valid for a large selection of Kvadrat upholstery.



W 54,5 cm / 21.5"



D 56 cm / 22"

H 77 cm / 30.3"
SH 46 cm / 18.1"



Configurable

Swivel Base w. gas lift & castors
— Shell

Materials

Shell from 100% recycled plastic reinforced with strength-improving additives and mixed with up to 25% FSC™-certified wood fibers. Due to the partly natural material of the shell, slight color variations can occur. 5-star swivel base and pressurized gas lift cylinder in die casted aluminum. Castors.

Certificates & Warranty

Strength & Stability: EN 16139 - L2, EN 1022, BIFMA X5.1. **Eco Labels & Safety:** Declare Red list approved, GreenTag Level C, VOC CDPH 01350 and BIFMA X7.1, FSC™, EU Ecolabel.
Warranty: 10 years

Options

Seat Pad.

Color Options & Codes

Shell: Natural White (close to RAL 9010), Black (RAL 7021), Dusty Green (RAL 7033), Grey (RAL 7030), Ochre (close to NCS S3040-Y20R).

Base: Anthracite Black (RAL 7021), Grey (RAL 7030) and Polished Aluminum with Black castors. White (RAL 9010) with White castors.

Dimensions

Total height:	72-84 cm / 28.3"-33.1"
Total width:	70 cm / 27.6"
Total depth:	70 cm / 27.6"
Seat height:	42-54 cm / 16.5"-22.3"
Seat depth:	46 cm / 18.1"
Seat width:	46 cm / 18.1"



Configurable

Swivel Base w. gas lift & castors
— Front Upholstery

Materials

Shell from 100% recycled plastic reinforced with strength-improving additives and mixed with up to 25% FSC™-certified wood fibers. Due to the partly natural material of the shell, slight color variations can occur. Front upholstered shell with textile, imitation leather, or leather. 5-star swivel base and pressurized gas lift cylinder in die casted aluminum. Castors.

Certificates & Warranty

Strength & Stability: EN 16139 - L2, EN 1022, BIFMA X5.1. **Eco Labels & Safety:** GreenTag Level C**, VOC CDPH 01350* and BIFMA X7.1*, FSC™, Crib 5 upon request.
Warranty: 10 years

Color Options & Codes

Upholstery: Textile, imitation leather, or leather. See the wide selection in our digital Product Configurator and visit our Price List for a full overview.

Shell: Natural White (close to RAL 9010), Black (RAL 7021), Dusty Green (RAL 7033), Grey (RAL 7030), Ochre (close to NCS S3040-Y20R). **Base:** Anthracite Black (RAL 7021), Grey (RAL 7030) and Polished Aluminum with Black castors. White (RAL 9010) with White castors.

Dimensions

Total height:	72-84 cm / 28.3"-33.1"
Total width:	70 cm / 27.6"
Total depth:	70 cm / 27.6"
Seat height:	42-54 cm / 16.5"-22.3"
Seat depth:	46 cm / 18.1"
Seat width:	46 cm / 18.1"



Configurable

Swivel Base w. gas lift & castors
— Full Upholstery

Materials

Shell from 100% recycled plastic reinforced with strength-improving additives and mixed with up to 25% FSC™-certified wood fibers. Fully upholstered shell with textile, imitation leather, or leather. 5-star swivel base and pressurized gas lift cylinder in die casted aluminum. Castors.

Certificates & Warranty

Strength & Stability: EN 16139 - L2, EN 1022, BIFMA X5.1. **Eco Labels & Safety:** GreenTag Level C**, VOC CDPH 01350* and BIFMA X7.1*, FSC™, Crib 5 upon request.
Warranty: 10 years

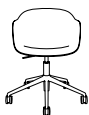
Color Options & Codes

Upholstery: Textile, imitation leather, or leather. See the wide selection in our digital Product Configurator and visit our Price List for a full overview.

Base: Anthracite Black (RAL 7021), Grey (RAL 7030) and Polished Aluminum with Black castors. White (RAL 9010) with White castors.

Dimensions

Total height:	72-84 cm / 28.3"-33.1"
Total width:	70 cm / 27.6"
Total depth:	70 cm / 27.6"
Seat height:	42-54 cm / 16.5"-22.3"
Seat depth:	46 cm / 18.1"
Seat width:	46 cm / 18.1"



W 70 cm / 27.6"



D 70 cm / 27.6"

fiber side chair

by Iskos-Berlin

The Fiber Side Chair brings a new perspective to the iconic shell chair. Made in an innovative composite of plastic and wood fibers, the Fiber Side Chair has a textured surface and a soft, inviting touch. When viewed from afar, the wood fibers of its shell blend into the surface for a matte finish yet appear when viewed up-close for a modern sentiment.

106

seating



Wood Base
— Shell

Materials

Shell from 100% recycled plastic reinforced with strength-improving additives and mixed with up to 25% FSC™-certified wood fibers. Due to the partly natural material of the shell, slight color variations can occur. Wood base in FSC™-certified solid oak with water-based lacquer. For Stained Dark Brown versions slight color variation can occur. Plastic glides.

Certificates & Warranty

Strength & Stability: EN 16139 - L2, EN 1022, BIFMA X5.4, BIFMA X5.1. **Eco Labels & Safety:** Declare Red list approved, GreenTag Level C, VOC CDPH 01350 and BIFMA X7.1, FSC™, EU Ecolabel.

Warranty: 10 years

Options

Felt glides. Seat Pad.

Color Options & Codes

Shell: Natural White (close to RAL 9010), Black (RAL 7021), Dusty Green (RAL 7033), Grey (RAL 7030), Ochre (close to NCS S3040-Y20R). **Base:** Oak, Stained Dark Brown, Anthracite Black (RAL 7021), Dusty Green (RAL 7033), Grey (RAL 7030).

Ready-To-Ship Options

Shell / Base

Natural White / Oak	
Black / Anthracite Black	
Dusty Green / Dusty Green	
Grey / Grey	
Ochre / Oak	

Dimensions

Total height:	77 cm / 30.3"
Total width:	49,5 cm / 19.5"
Total depth:	53 cm / 21"
Seat height:	46 cm / 18.1"
Seat width:	48 cm / 18.9"
Seat depth:	45 cm / 17.7"



W 49,5 cm / 19.5"



Wood Base
— Full Upholstery

Materials

Shell from 100% recycled plastic reinforced with strength-improving additives and mixed with up to 25% FSC™-certified wood fibers. Fully upholstered shell with textile, imitation leather, or leather. Wood base in FSC™-certified solid oak with water-based lacquer. For Stained Dark Brown versions slight color variation can occur. Plastic glides.

Certificates & Warranty

Strength & Stability: EN 16139 - L2, EN 1022, BIFMA X5.4, BIFMA X5.1. **Eco Labels & Safety:** GreenTag Level C**, VOC CDPH 01350* and BIFMA X7.1*, FSC™, Crib 5 upon request.

Warranty: 10 years

Options

Felt glides.

Color Options & Codes

Upholstery: Textile, imitation leather, or leather. See the wide selection in our digital Product Configurator and visit our Price List for a full overview.

Base: Oak, Stained Dark Brown, Anthracite Black (RAL 7021), Dusty Green (RAL 7033), Grey (RAL 7030).

Ready-To-Ship Options

Upholstery / Base

Refine Leather Cognac / Oak	
-----------------------------	--

Dimensions

Total height:	77 cm / 30.3"
Total width:	49,5 cm / 19.5"
Total depth:	53 cm / 21"
Seat height:	46 cm / 18.1"
Seat width:	48 cm / 18.9"
Seat depth:	45 cm / 17.7"



D 53 cm / 21"

H 77 cm / 30.3"
SH 46 cm / 18.1"

*Valid for a large selection of Kvadrat upholstery, Refine and Easy leather.
**Valid for a large selection of Kvadrat upholstery.



Tube Base
— Shell



Tube Base
— Full Upholstery

Materials

Shell from 100% recycled plastic reinforced with strength-improving additives and mixed with up to 25% FSC™-certified wood fibers. Due to the partly natural material of the shell, slight color variations can occur. Tube Base in powder coated steel. Plastic glides.

Certificates & Warranty

Strength & Stability: EN 16139 - L2, EN 1022, BIFMA X5.4. **Eco Labels & Safety:** Declare Red list approved, GreenTag Level C, VOC CDPH 01350 and BIFMA X7.1, FSC™, EU Ecolabel.

Warranty: 10 years

Options

Felt glides. Seat Pad.

Color Options & Codes

Shell: Natural White (close to RAL 9010), Black (RAL 7021), Dusty Green (RAL 7033), Grey (RAL 7030), Ochre (close to NCS S3040-Y20R).

Base: White (RAL 9010), Anthracite Black (RAL 7021), Dusty Green (RAL 7033), Grey (RAL 7030), Chrome.

Ready-To-Ship Options

Shell / Base

Natural White / White	<input type="radio"/> <input type="radio"/>
Black / Anthracite Black	<input checked="" type="radio"/> <input checked="" type="radio"/>
Dusty Green / Dusty Green	<input type="radio"/> <input type="radio"/>
Grey / Grey	<input type="radio"/> <input type="radio"/>
Ochre / Anthracite Black	<input type="radio"/> <input checked="" type="radio"/>

Dimensions

Total height:	77 cm / 30.3"
Total width:	51 cm / 20"
Total depth:	53 cm / 21"
Seat height:	46 cm / 18.1"
Seat width:	48 cm / 18.9"
Seat depth:	45 cm / 17.7"



W 51 cm / 20"



D 53 cm / 21"

H 77 cm / 30.3"
SH 46 cm / 18.1"

Materials

Shell from 100% recycled plastic reinforced with strength-improving additives and mixed with up to 25% FSC™-certified wood fibers. Fully upholstered shell with textile, imitation leather, or leather. Tube Base in powder coated steel. Plastic glides.

Certificates & Warranty

Strength & Stability: EN 16139 - L2, EN 1022, BIFMA X5.4. **Eco Labels & Safety:** GreenTag Level C**, VOC CDPH 01350* and BIFMA X7.1*, FSC™, Crib 5 upon request.

Warranty: 10 years

Options

Felt glides.

Color Options & Codes

Upholstery: Textile, imitation leather, or leather. See the wide selection in our digital Product Configurator and visit our Price List for a full overview.

Base: White (RAL 9010), Anthracite Black (RAL 7021), Dusty Green (RAL 7033), Grey (RAL 7030), Chrome.

Ready-To-Ship Options

Upholstery / Base

Refine Leather Cognac / Anthracite Black

Dimensions

Total height:	77 cm / 30.3"
Total width:	51 cm / 20"
Total depth:	53 cm / 21"
Seat height:	46 cm / 18.1"
Seat width:	48 cm / 18.9"
Seat depth:	45 cm / 17.7"

*Valid for a large selection of Kvadrat upholstery. Refine and Easy leather.
**Valid for a large selection of Kvadrat upholstery.

fiber side chair

by Iskos-Berlin

108

seating



Sled Base
— Shell

Materials

Shell from 100% recycled plastic reinforced with strength-improving additives and mixed with up to 25% FSC™-certified wood fibers. Due to the partly natural material of the shell, slight color variations can occur. Sled Base in powder coated steel. Plastic glides.

Certificates & Warranty

Strength & Stability: EN 16139 - L2, EN 1022, BIFMA X5.4. **Eco Labels & Safety:** Declare Red list approved. GreenTag Level C. VOC CDPH 01350 and BIFMA X7.1, FSC™, EU Ecolabel.

Warranty: 10 years

Options

Felt glides. Seat Pad.

Color Options & Codes

Shell: Natural White (close to RAL 9010), Black (RAL 7021), Dusty Green (RAL 7033), Grey (RAL 7030), Ochre (close to NCS S3040-Y20R)

Base: White (RAL 9010), Anthracite Black (RAL 7021), Dusty Green (RAL 7033), Grey (RAL 7030).

Dimensions

Total height:	77 cm / 30.3"
Total width:	47,5 cm / 18.7"
Total depth:	51,5 cm / 20.3"
Seat height:	46 cm / 18.1"
Seat width:	48 cm / 18.9"
Seat depth:	45 cm / 17.7"



Sled Base
— Full Upholstery

Materials

Shell from 100% recycled plastic reinforced with strength-improving additives and mixed with up to 25% FSC™-certified wood fibers. Fully upholstered shell with textile, imitation leather, or leather. Sled Base in powder coated steel. Plastic glides.

Certificates & Warranty

Strength & Stability: EN 16139 - L2, EN 1022, BIFMA X5.4. **Eco Labels & Safety:** GreenTag Level C**, VOC CDPH 01350* and BIFMA X7.1*, FSC™, Crib 5 upon request.

Warranty: 10 years

Options

Felt glides.

Color Options & Codes

Upholstery: Textile, imitation leather, or leather.

See the wide selection in our digital Product Configurator and visit our Price List for a full overview.

Base: White (RAL 9010), Anthracite Black (RAL 7021), Dusty Green (RAL 7033), Grey (RAL 7030).

Dimensions

Total height:	77 cm / 30.3"
Total width:	47,5 cm / 18.7"
Total depth:	51,5 cm / 20.3"
Seat height:	46 cm / 18.1"
Seat width:	48 cm / 18.9"
Seat depth:	45 cm / 17.7"

*Valid for a large selection of Kvadrat upholstery, Refine and Easy leather.
**Valid for a large selection of Kvadrat upholstery.



W 47,5 cm / 18.7"



D 51,5 cm / 20.3"

H 77 cm / 30.3"
SH 46 cm / 18.1"



Configurable

A-Base w. or w.o. linking device

— Shell

Stack up to 10 upholstered Fiber Side Chair A-Base.

Materials

Shell from 100% recycled plastic reinforced with strength-improving additives and mixed with up to 25% FSC™-certified wood fibers. Due to the partly natural material of the shell, slight color variations can occur. A-Base in chromed steel. Plastic glides.

Certificates & Warranty

Strength & Stability: EN 16139 - L2, EN 1022, BIFMA X5.4. **Eco Labels & Safety:** Declare Red list approved, GreenTag Level C, VOC CDPH 01350 and BIFMA X7.1, FSC™, EU Ecolabel. **Warranty:** 10 years

Options

Seat Pad. Trolley.

Color Options & Codes

Shell: Natural White (close to RAL 9010), Black (RAL 7021), Dusty Green (RAL 7033), Grey (RAL 7030), Ochre (close to NCS S3040-Y20R)

Base: Chrome.

Dimensions

Total height:	77 cm / 30.3"
Total width:	56 cm / 22"
Total depth:	53 cm / 21"
Seat height:	46 cm / 18.1"
Seat width:	48 cm / 18.9"
Seat depth:	45 cm / 17.7"
Total width w.o. linking device:	55,5 cm / 21.9"
Total width w. linking device:	57 cm / 22.5"



Configurable

A-Base w. or w.o. linking device

— Full Upholstery

Stack up to 10 upholstered Fiber Side Chair A-Base.

Materials

Shell from 100% recycled plastic reinforced with strength-improving additives and mixed with up to 25% FSC™-certified wood fibers. Fully upholstered shell with textile. A-Base in chromed steel. Plastic glides.

Certificates & Warranty

Strength & Stability: EN 16139 - L2, EN 1022, BIFMA X5.4. **Eco Labels & Safety:** GreenTag Level C*, VOC CDPH 01350* and BIFMA X7.1*, FSC™, Crib 5 upon request. **Warranty:** 10 years

Options

Trolley.

Color Options & Codes

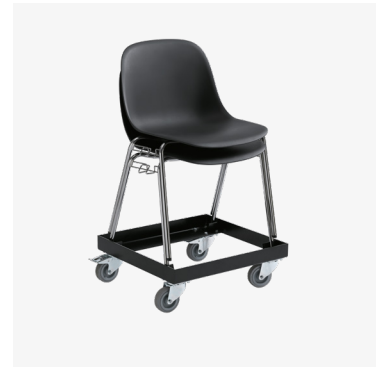
Upholstery: Textile.

See the wide selection in our digital Product Configurator and visit our Price List for a full overview.

Base: Chrome.

Dimensions

Total height:	77 cm / 30.3"
Total width:	56 cm / 22"
Total depth:	53 cm / 21"
Seat height:	46 cm / 18.1"
Seat width:	48 cm / 18.9"
Seat depth:	45 cm / 17.7"
Total width w.o. linking device:	55,5 cm / 21.9"
Total width w. linking device:	57 cm / 22.5"



Trolley

— Fiber Side Chair A-Base

A trolley for Fiber Side Chair A-Base that allows for easy storing and moving of multiple chairs at a time. The trolley can withstand a weight of 400 kg / 881.8 lb. Stack up to 15 non-upholstered chairs or 10 upholstered on Trolley.



W 55,5 cm / 21.9"



D 53 cm / 21"

H 77 cm / 30.3"
SH 46 cm / 18.1"



W 58 cm / 22.8"



D 54,6 cm / 21.5"

H 18,8 cm / 7.5"

fiber side chair

by Iskos-Berlin

110

seating



Configurable

Swivel Base w. or w.o. return — Shell

Materials

Shell from 100% recycled plastic reinforced with strength-improving additives and mixed with up to 25% FSC™-certified wood fibers. Due to the partly natural material of the shell, slight color variations can occur. Swivel base and cylinder in die casted aluminum. Plastic glides.

Certificates & Warranty

Strength & Stability: EN 16139 - L2, EN 1022, BIFMA X5.1**
Eco Labels & Safety: Declare Red list approved, GreenTag Level C, VOC CDPH 01350 and BIFMA X7.1, FSC™, EU Ecolabel.
Warranty: 10 years

Options

Felt glides. Seat Pad.

Color Options & Codes

Shell: Natural White (close to RAL 9010), Black (RAL 7021), Dusty Green (RAL 7033), Grey (RAL 7030), Ochre (close to NCS S3040-Y20R)

Base: White (RAL 9010), Anthracite Black (RAL 7021), Dusty Green (RAL 7033), Grey (RAL 7030), Polished Aluminum.

Dimensions

Total height:	77 cm / 30.3"
Total width:	47,5 cm / 18.75"
Total depth:	53 cm / 21"
Seat height:	46 cm / 18.1"
Seat width:	48 cm / 18.9"
Seat depth:	45 cm / 17.7"



Configurable

Swivel Base w. or w.o. return — Full Upholstery

Materials

Shell from 100% recycled plastic reinforced with strength-improving additives and mixed with up to 25% FSC™-certified wood fibers. Fully upholstered shell with textile, imitation leather, or leather. Swivel base and cylinder in die casted aluminum. Plastic glides.

Certificates & Warranty

Strength & Stability: EN 16139 - L2, EN 1022, BIFMA X5.1**
Eco Labels & Safety: GreenTag Level C***, VOC CDPH 01350* and BIFMA X7.1*, FSC™, Crib 5 upon request.
Warranty: 10 years

Options

Felt glides.



Color Options & Codes

Upholstery: Textile, imitation leather, or leather. See the wide selection in our digital Product Configurator and visit our Price List for a full overview.

Base: White (RAL 9010), Anthracite Black (RAL 7021), Dusty Green (RAL 7033), Grey (RAL 7030), Polished Aluminum.

Ready-To-Ship Options

Upholstery / Base

Refine Leather Cognac / Anthracite Black*  

*Valid for Swivel Base w.o. return

Dimensions

Total height:	77 cm / 30.3"
Total width:	47,5 cm / 18.75"
Total depth:	53 cm / 21"
Seat height:	46 cm / 18.1"
Seat width:	48 cm / 18.9"
Seat depth:	45 cm / 17.7"

*Valid for a large selection of Kontrat upholstery, Refine and Easy leather.

**Not allowed on Swivel Base with return.

***Valid for a large selection of Kontrat upholstery.



W 47,5 cm / 18.75"



D 53 cm / 21"

H 77 cm / 30.3"
SH 46 cm / 18.1"



Swivel Base w. castors
 — Shell

Materials

Shell from 100% recycled plastic reinforced with strength-improving additives and mixed with up to 25% FSC™- certified wood fibers. Due to the partly natural material of the shell, slight color variations can occur. Swivel base and cylinder in die casted aluminum. Castors.

Certificates & Warranty

Strength & Stability: EN 16139 - L2, EN 1022, BIFMA X5.1. **Eco Labels & Safety:** Declare Red list approved, GreenTag Level C, VOC CDPH 01350 and BIFMA X7.1, FSC™, EU Ecolabel.

Warranty: 10 years

Options

Seat Pad.

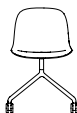
Color Options & Codes

Shell: Natural White (close to RAL 9010), Black (RAL 7021), Dusty Green (RAL 7033), Grey (RAL 7030), Ochre (close to NCS S3040-Y20R)

Base: Anthracite Black (RAL 7021), Dusty Green (RAL 7033), Grey (RAL 7030) and Polished Aluminum with Black castors. White (RAL 9010) with White castors.

Dimensions

Total height:	77 cm / 30.3"
Total width:	47,5 cm / 18.75"
Total depth:	53 cm / 21"
Seat height:	46 cm / 18.1"
Seat width:	48 cm / 18.9"
Seat depth:	45 cm / 17.7"



W 47,5 cm / 18.75"



Swivel Base w. castors
 — Full Upholstery

Materials

Shell from 100% recycled plastic reinforced with strength-improving additives and mixed with up to 25% FSC™- certified wood fibers. Fully upholstered shell with textile, imitation leather, or leather. Swivel base and cylinder in die casted aluminum. Castors.

Certificates & Warranty

Strength & Stability: EN 16139 - L2, EN 1022, BIFMA X5.1. **Eco Labels & Safety:** GreenTag Level C**, VOC CDPH 01350* and BIFMA X7.1*, FSC™, Crib 5 upon request.

Warranty: 10 years

Color Options & Codes

Upholstery: Textile, imitation leather, or leather.

See the wide selection in our digital Product Configurator and visit our Price List for a full overview.

Base: Anthracite Black (RAL 7021), Dusty Green (RAL 7033), Grey (RAL 7030) and Polished Aluminum with Black castors. White (RAL 9010) with White castors.

Dimensions

Total height:	77 cm / 30.3"
Total width:	47,5 cm / 18.75"
Total depth:	53 cm / 21"
Seat height:	46 cm / 18.1"
Seat width:	48 cm / 18.9"
Seat depth:	45 cm / 17.7"



D 53 cm / 21"

H 77 cm / 30.3"
 SH 46 cm / 18.1"

fiber side chair

by Iskos-Berlin

112

seating



Swivel Base w. gas lift & castors
— Shell

Materials

Shell from 100% recycled plastic reinforced with strength-improving additives and mixed with up to 25% FSC™-certified wood fibers. Due to the partly natural material of the shell, slight color variations can occur. 5-star swivel base and cylinder in die-casted aluminum. Pressurized gas lift cylinder. Castors.

Certificates & Warranty

Strength & Stability: EN 16139 - L2, EN 1022, BIFMA X5.1. **Eco Labels & Safety:** Declare Red list approved, GreenTag Level C, VOC CDPH 01350 and BIFMA X7.1, FSC™, EU Ecolabel.
Warranty: 10 years

Options

Seat Pad.

Color Options & Codes

Shell: Natural White (close to RAL 9010), Black (RAL 7021), Grey (RAL 7030). **Base:** Anthracite Black (RAL 7021), Grey (RAL 7030) and Polished Aluminum with Black castors. White (RAL 9010) with White castors.

Dimensions

Total height:	72-84 cm / 28.3"-33.1"
Total width:	70 cm / 27.6"
Total depth:	70 cm / 27.6"
Seat height:	42-54 cm / 16.5"-22.3"
Seat width:	48 cm / 18.9"
Seat depth:	45 cm / 17.7"



Swivel Base w. gas lift & castors
— Full Upholstery

Materials

Shell from 100% recycled plastic reinforced with strength-improving additives and mixed with up to 25% FSC™-certified wood fibers. Fully upholstered shell with textile, imitation leather, or leather. 5-star swivel base and cylinder in die-casted aluminum. Pressurized gas lift cylinder. Castors.

Certificates & Warranty

Strength & Stability: EN 16139 - L2, EN 1022, BIFMA X5.1. **Eco Labels & Safety:** GreenTag Level C**, VOC CDPH 01350* and BIFMA X7.1*, FSC™, FSC™, Crib 5 upon request.
Warranty: 10 years

Color Options & Codes

Upholstery: Textile, imitation leather, or leather. See the wide selection in our digital Product Configurator and visit our Price List for a full overview.
Base: Anthracite Black (RAL 7021), Grey (RAL 7030) and Polished Aluminum with Black castors. White (RAL 9010) with White castors.

Dimensions

Total height:	72-84 cm / 28.3"-33.1"
Total width:	70 cm / 27.6"
Total depth:	70 cm / 27.6"
Seat height:	42-54 cm / 16.5"-22.3"
Seat width:	48 cm / 18.9"
Seat depth:	45 cm / 17.7"

*Valid for a large selection of Kvadrat upholstery, Refine and Easy leather.
**Valid for a large selection of Kvadrat upholstery.



W 70 cm / 27.6"



D 70 cm / 27.6"

H 72-84 cm / 28.3"-33.1"
SH 42-54 cm / 16.5"-22.3"

fiber bar & counter stool

by Iskos-Berlin

The Fiber Bar Stool & Counter Stool have a modern expression with their seat made in an innovative composite of wood and plastic fibers for a deep, matte surface and soft touch. They come with a wood or tube base, with or without upholstery or backrest.



Wood Base (w.o backrest)
— Shell

Materials

Shell from 100% recycled plastic reinforced with strength-improving additives and mixed with up to 25% FSC™-certified wood fibers. Due to the partly natural material of the shell, slight color variations can occur. Wood base in FSC™-certified solid oak with water-based lacquer. For Stained Dark Brown versions slight color variation can occur. Footrest in stainless steel (oak version) or powder coated steel (colored version). Plastic glides.

Certificates & Warranty

Strength & Stability: EN 16139 - L2, EN 1022, BIFMA X5.4. **Eco Labels & Safety:** Declare Red list approved, GreenTag Level C, VOC CDPH 01350 and BIFMA X7.1, FSC™, EU Ecolabel.
Warranty: 10 years

Options

Felt glides.

Color Options & Codes

Shell: Natural White (close to RAL 9010), Black (RAL 7021), Dusty Green (RAL 7033), Grey (RAL 7030), Ochre (close to NCS S3040-Y20R).

Base: Oak, Stained Dark Brown, Anthracite Black (RAL 7021), Dusty Green (RAL 7033), Grey (RAL 7030).

Ready-To-Ship Options

Shell / Base

Natural White / Oak	
Black / Anthracite Black	
Grey / Grey	

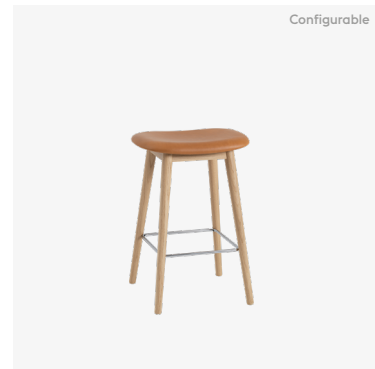
Dimensions

Bar Stool w.o backrest

Height:	76 cm / 30"
Width:	45 cm / 17.75"
Depth:	45,5 cm / 18"
Seat height:	75 cm / 29.5"
Seat depth:	41,5cm / 16.3"

Counter Stool w.o backrest

Height:	66 cm / 26"
Width:	45 cm / 17.75"
Depth:	42,5" / 16.75"
Seat height:	65 cm / 25.5"
Seat depth:	41,5cm / 16.3"



Wood Base (w.o backrest)
— Full Upholstery

Materials

Shell from 100% recycled plastic reinforced with strength-improving additives and mixed with up to 25% FSC™-certified wood fibers. Fully upholstered shell with textile, imitation leather, or leather. Wood base in FSC™-certified solid oak with water-based lacquer. For Stained Dark Brown versions slight color variation can occur. Footrest in stainless steel (oak version) or powder coated steel (colored version). Plastic glides.

Certificates & Warranty

Strength & Stability: EN 16139 - L2, EN 1022, BIFMA X5.4. **Eco Labels & Safety:** GreenTag Level C**, VOC CDPH 01350* and BIFMA X7.1*, FSC™, Crib 5 upon request.
Warranty: 10 years

Options

Felt glides.

Color Options & Codes

Upholstery: Textile, imitation leather, or leather. See the wide selection in our digital Product Configurator and visit our Price List for a full overview.

Base: Oak, Stained Dark Brown, Anthracite Black (RAL 7021), Dusty Green (RAL 7033), Grey (RAL 7030).

Ready-To-Ship Options

Upholstery / Base

Refine Leather Cognac / Oak	
-----------------------------	--

Dimensions

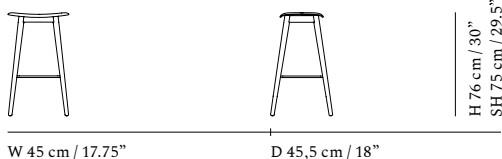
Bar Stool w.o backrest

Height:	76 cm / 30"
Width:	45 cm / 17.75"
Depth:	45,5 cm / 18"
Seat height:	75 cm / 29.5"
Seat depth:	41,5cm / 16.3"

Counter Stool w.o backrest

Height:	66 cm / 26"
Width:	45 cm / 17.75"
Depth:	42,5" / 16.75"
Seat height:	65 cm / 25.5"
Seat depth:	41,5cm / 16.3"

*Valid for a large selection of Kvadrat upholstery. **Valid for a large selection of Kvadrat upholstery.



fiber bar & counter stool

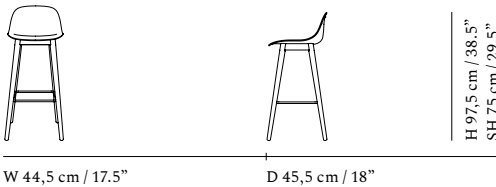
by Iskos-Berlin

114

seating



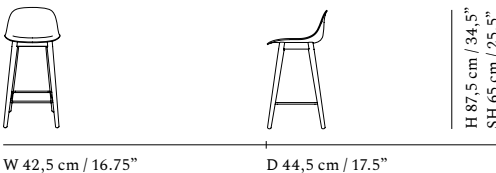
*Valid for a large selection of Kvadrat upholstery.
 Refine and Easy leather.
 **Valid for a large selection of Kvadrat upholstery.



W 44,5 cm / 17.5"

D 45,5 cm / 18"

H 97,5 cm / 38.5"
 SH 75 cm / 29.5"



W 42,5 cm / 16.75"

D 44,5 cm / 17.5"

H 87,5 cm / 34.5"
 SH 65 cm / 25.5"



Wood Base (w. backrest)
 — Shell

Materials

Shell from 100% recycled plastic reinforced with strength-improving additives and mixed with up to 25% FSC™-certified wood fibers. Due to the partly natural material of the shell, slight color variations can occur. Wood base in FSC™-certified solid oak with water-based lacquer. For Stained Dark Brown versions slight color variation can occur. Footrest in stainless steel (oak version) or powder coated steel (colored version). Plastic glides.

Certificates & Warranty

Strength & Stability: EN 16139 - L2, EN 1022, BIFMA X5.4. **Eco Labels & Safety:** Declare Red list approved, GreenTag Level C, VOC CDPH 01350 and BIFMA X7.1, FSC™, EU Ecolabel.
Warranty: 10 years

Options

Felt glides.

Color Options & Codes

Shell: Natural White (close to RAL 9010), Black (RAL 7021), Dusty Green (RAL 7033), Grey (RAL 7030), Ochre (close to NCS S3040-Y20R).

Base: Oak, Stained Dark Brown, Anthracite Black (RAL 7021), Dusty Green (RAL 7033), Grey (RAL 7030).

Ready-To-Ship Options

Shell / Base

Natural White / Oak	
Black / Anthracite Black	
Grey / Grey	

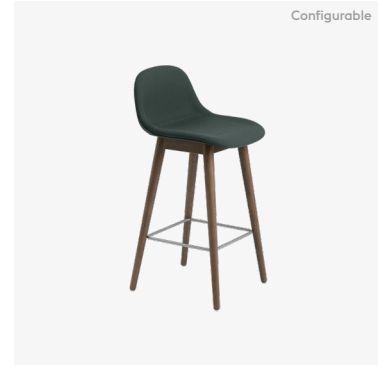
Dimensions

Bar Stool w. backrest

Height:	97,5 cm / 38.5"
Width:	44,5 cm / 17.5"
Depth:	45,5 cm / 18"
Seat height:	75 cm / 29.5"
Seat depth:	41,5cm / 16.3"

Counter Stool w. backrest

Height:	87,5 cm / 34.5"
Width:	42,5 cm / 16.75"
Depth:	44,5 cm / 17.5"
Seat height:	65 cm / 25.5"
Seat depth:	41,5cm / 16.3"



Wood Base (w. backrest)
 — Full Upholstery

Materials

Shell from 100% recycled plastic reinforced with strength-improving additives and mixed with up to 25% FSC™-certified wood fibers. Fully upholstered shell with textile, imitation leather, or leather. Wood base in FSC™-certified solid oak with water-based lacquer. For Stained Dark Brown versions slight color variation can occur. Footrest in stainless steel (oak version) or powder coated steel (colored version). Plastic glides.

Certificates & Warranty

Strength & Stability: EN 16139 - L2, EN 1022, BIFMA X5.4. **Eco Labels & Safety:** GreenTag Level C**, VOC CDPH 01350* and BIFMA X7.1*, FSC™, Crib 5 upon request.
Warranty: 10 years

Options

Felt glides.

Color Options & Codes

Upholstery: Textile, imitation leather, or leather. See the wide selection in our digital Product Configurator and visit our Price List for a full overview.

Base: Oak, Stained Dark Brown, Anthracite Black (RAL 7021), Dusty Green (RAL 7033), Grey (RAL 7030).

Ready-To-Ship Options

Upholstery / Base

Refine Leather Cognac / Oak	
-----------------------------	--

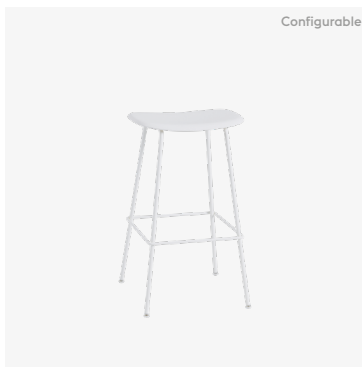
Dimensions

Bar Stool w. backrest

Height:	97,5 cm / 38.5"
Width:	44,5 cm / 17.5"
Depth:	45,5 cm / 18"
Seat height:	75 cm / 29.5"
Seat depth:	41,5cm / 16.3"

Counter Stool w. backrest

Height:	87,5 cm / 34.5"
Width:	42,5 cm / 16.75"
Depth:	44,5 cm / 17.5"
Seat height:	65 cm / 25.5"
Seat depth:	41,5cm / 16.3"



Configurable

Tube Base (w.o backrest)

— Shell

Materials

Shell from 100% recycled plastic reinforced with strength-improving additives and mixed with up to 25% FSC™- certified wood fibers. Due to the partly natural material of the shell, slight color variations can occur. Tube Base in powder coated steel. Plastic glides.

Certificates & Warranty

Strength & Stability: EN 16139 - L2, EN 1022, BIFMA X5.4. **Eco Labels & Safety:** Declare Red list approved, GreenTag Level C, VOC CDPH 01350 and BIFMA X7.1, FSC™, EU Ecolabel.
Warranty: 10 years

Options

Felt glides.

Color Options & Codes

Shell: Natural White (close to RAL 9010), Black (RAL 7021), Dusty Green (RAL 7033), Grey (RAL 7030), Ochre (close to NCS S3040-Y20R).

Base: Anthracite Black (RAL 7021), Dusty Green (RAL 7033), Grey (RAL 7030), White (RAL 9010).

Ready-To-Ship Options

Shell / Base

Natural White / White

Black / Anthracite Black

Grey / Grey

Dimensions

Bar Stool w.o backrest

Height: 76 cm / 30"
 Width: 45 cm / 17.75"
 Depth: 46,5 cm / 18.25"
 Seat height: 75 cm / 29.5"
 Seat depth: 41,5cm / 16.3"

Counter Stool w.o backrest

Height: 66 cm / 26"
 Width: 44 cm / 17.25"
 Depth: 44 cm / 17.5"
 Seat height: 65 cm / 25.5"
 Seat depth: 41,5cm / 16.3"



W 45 cm / 17.75"



D 46,5 cm / 18.25"

H 76 cm / 30"
 SH 75 cm / 29.5"

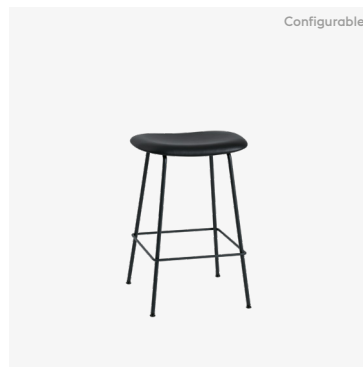


W 44 cm / 17.25"



D 44 cm / 17.25"

H 66 cm / 26"
 SH 65 cm / 25.5"



Configurable

Tube Base (w.o backrest)

— Full Upholstery

Materials

Shell from 100% recycled plastic reinforced with strength-improving additives and mixed with up to 25% FSC™- certified wood fibers. Fully upholstered shell with textile, imitation leather, or leather. Tube Base in powder coated steel. Plastic glides.

Certificates & Warranty

Strength & Stability: EN 16139 - L2, EN 1022, BIFMA X5.4. **Eco Labels & Safety:** GreenTag Level C**, VOC CDPH 01350* and BIFMA X7.1*, FSC™, Crib 5 upon request.

Warranty: 10 years

Options

Felt glides.

Color Options & Codes

Upholstery: Textile, imitation leather, or leather.

See the wide selection in our digital Product Configurator and visit our Price List for a full overview.

Base: Anthracite Black (RAL 7021), Dusty Green (RAL 7033), Grey (RAL 7030), White (RAL 9010).

Ready-To-Ship Options

Upholstery / Base

Refine Leather Cognac / Anthracite Black

Dimensions

Bar Stool w.o backrest

Height: 76 cm / 30"
 Width: 45 cm / 17.75"
 Depth: 46,5 cm / 18.25"
 Seat height: 75 cm / 29.5"
 Seat depth: 41,5cm / 16.3"

Counter Stool w.o backrest

Height: 66 cm / 26"
 Width: 44 cm / 17.25"
 Depth: 44 cm / 17.5"
 Seat height: 65 cm / 25.5"
 Seat depth: 41,5cm / 16.3"

fiber bar & counter stool

by Iskos-Berlin



***Valid for a large selection of Kvadrat upholstery.
Refine and Easy leather.
***Valid for a large selection of Kvadrat upholstery.



Tube Base (w. backrest)
— Shell

Materials

Shell from 100% recycled plastic reinforced with strength-improving additives and mixed with up to 25% FSC™- certified wood fibers. Due to the partly natural material of the shell, slight color variations can occur. Tube Base in powder coated steel. Plastic glides.

Certificates & Warranty

Strength & Stability: EN 16139 - L2, EN 1022, BIFMA X5.4. **Eco Labels & Safety:** Declare Red list approved, GreenTag Level C, VOC CDPH 01350 and BIFMA X7.1, FSC™, EU Ecolabel.
Warranty: 10 years

Options

Felt glides.

Color Options & Codes

Shell: Natural White (close to RAL 9010), Black (RAL 7021), Dusty Green (RAL 7033), Grey (RAL 7030), Ochre (close to NCS S3040-Y20R).

Base: Anthracite Black (RAL 7021), Dusty Green (RAL 7033), Grey (RAL 7030), White (RAL 9010).

Ready-To-Ship Options

Shell / Base

Natural White / White

Black / Anthracite Black

Grey / Grey

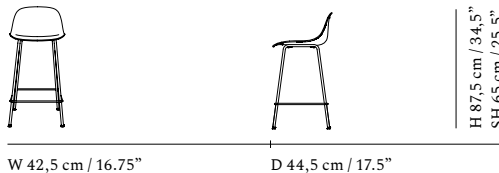
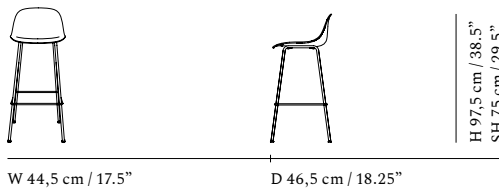
Dimensions

Bar Stool w. backrest

Height: 97,5 cm / 38.5"
Width: 44,5 cm / 17.5"
Depth: 46,5 cm / 18.25"
Seat height: 75 cm / 29.5"
Seat depth: 41,5cm / 16.3"

Counter Stool w. backrest

Height: 87,5 cm / 34.5"
Width: 42,5 cm / 16.75"
Depth: 44,5 cm / 17.5"
Seat height: 65 cm / 25.5"
Seat depth: 41,5cm / 16.3"



Tube Base (w. backrest)
— Full Upholstery

Materials

Shell from 100% recycled plastic reinforced with strength-improving additives and mixed with up to 25% FSC™- certified wood fibers. Fully upholstered shell with textile, imitation leather, or leather. Tube Base in powder coated steel. Plastic glides.

Certificates & Warranty

Strength & Stability: EN 16139 - L2, EN 1022, BIFMA X5.4. **Eco Labels & Safety:** GreenTag Level C**, VOC CDPH 01350* and BIFMA X7.1*, FSC™, Crib 5 upon request.
Warranty: 10 years

Options

Felt glides.

Color Options & Codes

Upholstery: Textile, imitation leather, or leather.

See the wide selection in our digital Product Configurator and visit our Price List for a full overview.

Base: Anthracite Black (RAL 7021), Dusty Green (RAL 7033), Grey (RAL 7030), White (RAL 9010).

Ready-To-Ship Options

Upholstery / Base

Refine Leather Cognac / Anthracite Black

Dimensions

Bar Stool w. backrest

Height: 97,5 cm / 38.5"
Width: 44,5 cm / 17.5"
Depth: 46,5 cm / 18.25"
Seat height: 75 cm / 29.5"
Seat depth: 41,5cm / 16.3"

Counter Stool w. backrest

Height: 87,5 cm / 34.5"
Width: 42,5 cm / 16.75"
Depth: 44,5 cm / 17.5"
Seat height: 65 cm / 25.5"
Seat depth: 41,5cm / 16.3"

fiber stool

by Iskos-Berlin

With an expression that is comfortable and harmonious, the Fiber Stool is a design with an unobtrusive yet distinct identity. Ideal for adding an extra seat where needed, whether at the dining table or in a meeting setup.



Wood Base
— Shell

Materials

Shell from 100% recycled plastic reinforced with strength-improving additives and mixed with up to 25% FSC™-certified wood fibers. Due to the partly natural material of the shell, slight color variations can occur. Wood base in FSC™-certified solid oak with water-based lacquer. For Stained Dark Brown versions slight color variation can occur. Plastic glides.

Certificates & Warranty

Strength & Stability: EN 16139 - L2, EN 1022.

Eco Labels & Safety: Declare Red list approved, GreenTag Level C, VOC CDPH 01350 and BIFMA X7.1, FSC™, EU Ecolabel.

Warranty: 5 years

Options

Felt glides.

Color Options & Codes

Shell: Natural White (close to RAL 9010), Black (RAL 7021), Dusty Green (RAL 7033), Grey (RAL 7030), Ochre (close to NCS S3040-Y20R).

Base: Oak, Stained Dark Brown, Anthracite Black (RAL 7021), Dusty Green (RAL 7033), Grey (RAL 7030).

Dimensions

Height:	46 cm / 18"
Width:	45 cm / 17.75"
Depth:	38,8 cm / 15.3"
Seat height:	45 cm / 17.75"
Seat depth:	32 cm / 12.6"



Wood Base
— Full Upholstery

Materials

Shell from 100% recycled plastic reinforced with strength-improving additives and mixed with up to 25% FSC™-certified wood fibers. Fully upholstered shell with textile, imitation leather, or leather. Wood base in FSC™-certified solid oak with water-based lacquer. For Stained Dark Brown versions slight color variation can occur. Plastic glides.

Certificates & Warranty

Strength & Stability: EN 16139 - L2, EN 1022.

Eco Labels & Safety: GreenTag Level C**, VOC CDPH 01350* and BIFMA X7.1*, FSC™, Crib 5 upon request.

Warranty: 5 years

Options

Felt glides.

Color Options & Codes

Upholstery: Textile, imitation leather, or leather.

See the wide selection in our digital Product Configurator and visit our Price List for a full overview.

Base: Oak, Stained Dark Brown, Anthracite Black (RAL 7021), Dusty Green (RAL 7033), Grey (RAL 7030).

Dimensions

Height:	46 cm / 18"
Width:	45 cm / 17.75"
Depth:	38,8 cm / 15.3"
Seat height:	45 cm / 17.75"
Seat depth:	32 cm / 12.6"

*Valid for a large selection of Kvadrat upholstery. Refine and Easy leather.
**Valid for a large selection of Kvadrat upholstery.



W 45 cm / 17.75"



D 38,8 cm / 15.3"

H 46 cm / 18"
SH 45 cm / 17.75"

fiber stool

by Iskos-Berlin



Tube Base
— Shell

Materials

Shell from 100% recycled plastic reinforced with strength-improving additives and mixed with up to 25% FSC™- certified wood fibers. Due to the partly natural material of the shell, slight color variations can occur. Tube Base in powder coated steel. Plastic glides.

Certificates & Warranty

Strength & Stability: EN 16139 - L2, EN 1022.

Eco Labels & Safety: Declare Red list approved, GreenTag Level C, VOC CDPH 01350 and BIFMA X7.1, FSC™, EU Ecolabel.

Warranty: 5 years

Options

Felt glides.

Color Options & Codes

Shell: Natural White (close to RAL 9010), Black (RAL 7021), Dusty Green (RAL 7033), Grey (RAL 7030), Ochre (close to NCS S3040-Y20R).

Base: Anthracite Black (RAL 7021), Dusty Green (RAL 7033), Grey (RAL 7030), White (RAL 9010).

Dimensions

Height:	46 cm / 18"
Width:	45 cm / 17.75"
Depth:	35,5 cm / 14"
Seat height:	45 cm / 17.75"
Seat depth:	32 cm / 12.6"



Tube Base
— Full Upholstery

Materials

Shell from 100% recycled plastic reinforced with strength-improving additives and mixed with up to 25% FSC™- certified wood fibers. Fully upholstered shell with textile, imitation leather, or leather. Tube Base in powder coated steel. Plastic glides.

Certificates & Warranty

Strength & Stability: EN 16139 - L2, EN 1022.

Eco Labels & Safety: GreenTag Level C™, VOC CDPH 01350* and BIFMA X7.1*, FSC™, Crib 5 upon request.

Warranty: 5 years

Options

Felt glides.

Color Options & Codes

Upholstery: Textile, imitation leather, or leather.

See the wide selection in our digital Product Configurator and visit our Price List for a full overview.

Base: Anthracite Black (RAL 7021), Dusty Green (RAL 7033), Grey (RAL 7030), White (RAL 9010).

Dimensions

Height:	46 cm / 18"
Width:	45 cm / 17.75"
Depth:	35,5 cm / 14"
Seat height:	45 cm / 17.75"
Seat depth:	32 cm / 12.6"

*Valid for a large selection of Kvadrat upholstery, Refine and Easy leather.
**Valid for a large selection of Kvadrat upholstery.



W 45 cm / 17.75"



D 35,5 cm / 14"

H 46 cm / 18"
SH 45 cm / 17.75"

fiber lounge armchair

by Iskos-Berlin

The Fiber Lounge Armchair features a generously spacious seat and embracing curves that embody the elegance of the Fiber Series in a softer, more inviting form. The chair's shell is made from 100% recycled plastic, supported by a tube base in powder-coated steel or a wood base in FSC™-certified solid oak.



Wood Base
— Full Upholstery

Materials

Shell from 100% recycled plastic mixed with strength-improving additives. The recycled plastic comes from post-consumer waste. The shell is clad with foam and wadding and finished with textile, imitation leather, or leather upholstery. Wood base in FSC™-certified oak with water-based lacquer. For the Stained Dark Brown version slight color variations can occur. Plastic glides.

Certificates & Warranty

Strength & Stability: BIFMA X5.4

Eco Labels & Safety: FSC™

Warranty: 10 years

Options

Felt glides

Color Options & Codes

Upholstery: Textile, imitation leather, or leather. See the wide selection in our digital Product Configurator and visit our Price List for a full overview.

Base: Oak, Stained Dark Brown, Grey (RAL 7030), Dusty Green (RAL 7033), Anthracite Black (RAL 7021)

Ready-To-Ship Options

Upholstery/base

Ecriture 240 / Oak



Refine Leather Cognac / Anthracite Black



Dimensions

Total height:	88,1 cm / 34.7"
Total width:	75 cm / 29.5"
Total depth:	83,3 cm / 32.8"
Seat height:	42,8 cm / 16.9"
Seat width:	58 cm / 22.8"
Seat depth:	53 cm / 20.9"



Tube Base
— Full Upholstery

Materials

Shell from 100% recycled plastic mixed with strength-improving additives. The recycled plastic comes from post-consumer waste. The shell is clad with foam and wadding and finished with textile, imitation leather, or leather upholstery. Tube base in powder-coated steel. Plastic glides.

Certificates & Warranty

Strength & Stability: BIFMA X5.4

Warranty: 10 years

Options

Felt glides

Color Options & Codes

Upholstery: Textile, imitation leather, or leather. See the wide selection in our digital Product Configurator and visit our Price List for a full overview.

Base: Grey (RAL 7030), Dusty Green (RAL 7033), Anthracite Black (RAL 7021)

Ready-To-Ship Options

Upholstery/base

Ecriture 240 / Grey



Refine Leather Cognac / Anthracite Black



Dimensions

Total height:	88,1 cm / 34.7"
Total width:	75 cm / 29.5"
Total depth:	83,3 cm / 32.8"
Seat height:	42,8 cm / 16.9"
Seat width:	58 cm / 22.8"
Seat depth:	53 cm / 20.9"



W 75 cm / 29.5"



D 83,3 cm / 32.8"

H 88,1 cm / 34.7"
SH 42,8 cm / 16.9"



W 75 cm / 29.5"



D 83,3 cm / 32.8"

H 88,1 cm / 34.7"
SH 42,8 cm / 16.9"

fiber lounge chair

by Iskos-Berlin

With an embracing seat and a lightly hovering appearance, the Fiber Lounge Chair invites the user for a refined and comfortable lounging experience. The design's soft and rounded curves gives the chair a welcoming look for any lounge setting.



Wood Base
— Shell

Materials

Shell from 100% recycled plastic reinforced with strength-improving additives and mixed with up to 25% FSC™-certified wood fibers. Due to the partly natural material of the shell, slight color variations can occur. Wood base in FSC™-certified solid oak with water-based lacquer. For Stained Dark Brown versions slight color variation can occur. Plastic glides.

Certificates & Warranty

Strength & Stability: EN 16139 - L2, EN 1022, BIFMA X5.4. **Eco Labels & Safety:** Declare Red list approved, GreenTag Level C, VOC CDPH 01350 and BIFMA X7.1, FSC™, EU Ecolabel.
Warranty: 10 years

Options

Felt glides. Seat Pad.

Color Options & Codes

Shell: Natural White (close to RAL 9010), Black (RAL 7021), Dusty Green (RAL 7033), Grey (RAL 7030), Ochre (close to NCS S3040-Y20R).

Base: Oak, Stained Dark Brown, Anthracite Black (RAL 7021), Dusty Green (RAL 7033), Grey (RAL 7030).

Dimensions

Total height:	74,4 cm / 29.3"
Total width:	60 cm / 23.6"
Total depth:	69 cm / 27.2"
Seat height:	38 cm / 15"
Seat width:	60 cm / 23.6"
Seat depth:	49 cm / 19.3"



Wood Base
— Full Upholstery

Materials

Shell from 100% recycled plastic reinforced with strength-improving additives and mixed with up to 25% FSC™-certified wood fibers. Fully upholstered shell with textile, imitation leather, or leather. Wood base in FSC™-certified solid oak with water-based lacquer. For Stained Dark Brown versions slight color variation can occur. Plastic glides.

Certificates & Warranty

Strength & Stability: EN 16139 - L2, EN 1022, BIFMA X5.4. **Eco Labels & Safety:** GreenTag Level C**, VOC CDPH 01350* and BIFMA X7.1*, FSC™, Crib 5 upon request.
Warranty: 10 years

Options

Felt glides.

Color Options & Codes

Upholstery: Textile, imitation leather, or leather. See the wide selection in our digital Product Configurator and visit our Price List for a full overview.

Base: Oak, Stained Dark Brown, Anthracite Black (RAL 7021), Dusty Green (RAL 7033), Grey (RAL 7030).

Dimensions

Total height:	74,4 cm / 29.3"
Total width:	60 cm / 23.6"
Total depth:	69 cm / 27.2"
Seat height:	38 cm / 15"
Seat width:	60 cm / 23.6"
Seat depth:	49 cm / 19.3"

*Valid for a large selection of Kvadrat upholstery, Refine and Easy leather.
**Valid for a large selection of Kvadrat upholstery.



W 60 cm / 23.6"



D 69 cm / 27.2"

H 74,4 cm / 29,3"
SH 38 cm / 15"



Tube Base
— Shell

Materials

Shell from 100% recycled plastic reinforced with strength-improving additives and mixed with up to 25% FSC™-certified wood fibers. Due to the partly natural material of the shell, slight color variations can occur. Tube Base in powder coated steel. Plastic glides.

Certificates & Warranty

Strength & Stability: EN 16139 - L2, EN 1022, BIFMA X5.4. **Eco Labels & Safety:** Declare Red list approved, GreenTag Level C, VOC CDPH 01350 and BIFMA X7.1, FSC™, EU Ecolabel.

Warranty: 10 years

Options

Felt glides. Seat Pad.

Color Options & Codes

Shell: Natural White (close to RAL 9010), Black (RAL 7021), Dusty Green (RAL 7033), Grey (RAL 7030), Ochre (close to NCS S3040-Y20R).

Base: White (RAL 9010), Anthracite Black (RAL 7021), Dusty Green (RAL 7033), Grey (RAL 7030).

Dimensions

Total height:	74,4 cm / 29.3"
Total width:	60 cm / 23.6"
Total depth:	69 cm / 27.2"
Seat height:	38 cm / 15"
Seat width:	60 cm / 23.6"
Seat depth:	49 cm / 19.3"



Tube Base
— Full Upholstery

Materials

Shell from 100% recycled plastic reinforced with strength-improving additives and mixed with up to 25% FSC™-certified wood fibers. Fully upholstered shell with textile, imitation leather, or leather. Tube Base in powder coated steel. Plastic glides.

Certificates & Warranty

Strength & Stability: EN 16139 - L2, EN 1022, BIFMA X5.4. **Eco Labels & Safety:** GreenTag Level C™, VOC CDPH 01350* and BIFMA X7.1*, FSC™, Crib 5 upon request.

Warranty: 10 years

Options

Felt glides.

Color Options & Codes

Upholstery: Textile, imitation leather, or leather.

See the wide selection in our digital Product Configurator and visit our Price List for a full overview.

Base: White (RAL 9010), Anthracite Black (RAL 7021), Dusty Green (RAL 7033), Grey (RAL 7030).

Dimensions

Total height:	74,4 cm / 29.3"
Total width:	60 cm / 23.6"
Total depth:	69 cm / 27.2"
Seat height:	38 cm / 15"
Seat width:	60 cm / 23.6"
Seat depth:	49 cm / 19.3"

*Valid for a large selection of Kvadrat upholstery. Refine and Easy leather.
**Valid for a large selection of Kvadrat upholstery.



W 60 cm / 23.6"



D 69 cm / 27.2"

H 74,4 cm / 29.3"
SH 38 cm / 15"

Bringing a sculptural expression to Scandinavian design, the Oslo Family has a light, airy, warm, and inviting appearance. With its slender, long legs and embracingly elegant cushions, Oslo's contemporary look, combined with its extensive comfort and high functionality, makes the design ideal for high-end dining spaces, lobbies, and other high-traffic lounge areas.

oslo

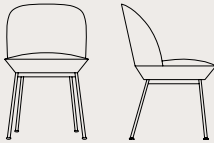


family

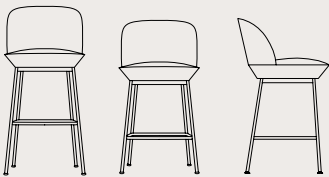
by Anderssen & Voll



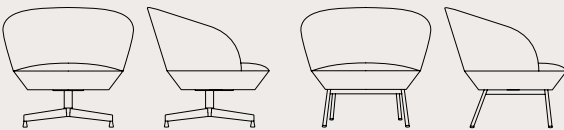
The Oslo Family spans its ethos across multiple members from the Oslo Side Chair, Bar & Counter Stool, Oslo Lounge Chairs, and Sofas in various sizes, as well as a Bench and a Pouf. The Oslo Side Chair and the Oslo Bar & Counter Stool are contemporary perspectives on the upholstered dining chair and bar stool.



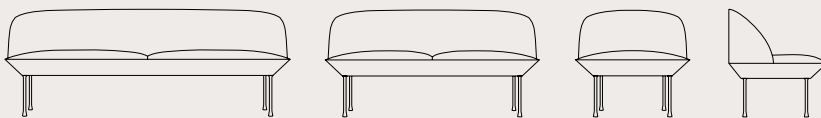
Side Chair



Bar & Counter Stool



Lounge Chair



Sofa
3-seater, 2-seater & 1-Seater



Bench & Pouf

oslo side chair, bar & counter stool

by Anderssen & Voll

Combining modern, geometric lines with a light expression and a comfortably soft seat, the Oslo Side Chair, Bar & Counter Stool brings a refined perspective to the form through its playful lines and embracing back. The Oslo Side Chair and Bar & Counter Stool add an elegant touch to any space, whether a restaurant, bar, conference room, or corporate setting.



Oslo Side Chair
— Tube Base

Materials

Shell with moulded foam and textile upholstery. Base in chrome or powder coated steel. Plastic gliders.

Certificates & Warranty

Strength & Stability: EN 16139 - L2, EN 1022, BIFMA X5.4 upon request. **Eco Labels & Safety:** Declare Red List approved*, VOC CDPH 01350* and BIFMA X7.1*, Crib 5 upon request. **Warranty:** 5 years. 10 years upon request.

Options

Felt glides.

Color Options & Codes

Upholstery: Textile. See the wide selection in our digital Product Configurator and visit our Price List for a full overview.
Base: Anthracite Black (RAL 7021), Chrome.

Dimensions

Height:	80,5 cm / 31.7"
Width:	51 cm / 20.08"
Depth:	56 cm / 22.05"
Seat height:	48 cm / 18.89"
Seat depth:	44 cm / 17.32"
Seat width:	49 cm / 19.29"



Oslo Bar & Counter Stool
— Tube Base

Materials

Shell with moulded foam and textile upholstery. Base in chrome or powder coated steel. Plastic gliders.

Certificates & Warranty

Strength & Stability: EN 16139 - L2, BIFMA X5.1. **Eco Labels & Safety:** Declare Red List approved*, VOC CDPH 01350* and BIFMA X7.1*, Crib 5 upon request. **Warranty:** 10 years.

Options

Felt glides.

Color Options & Codes

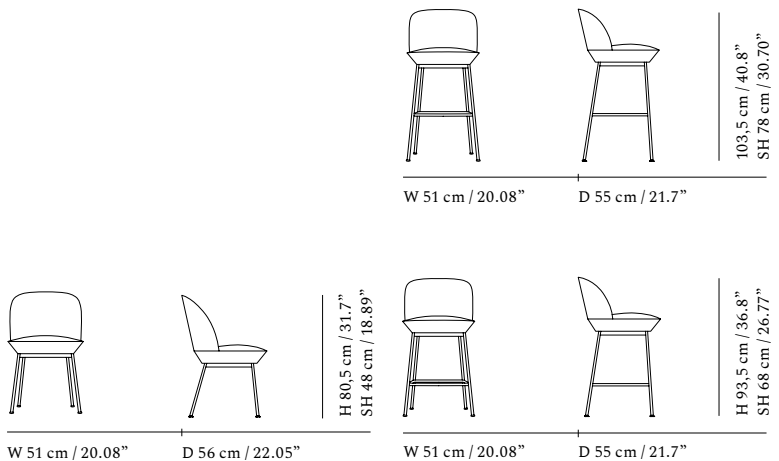
Upholstery: Textile. See the wide selection in our digital Product Configurator and visit our Price List for a full overview.
Base: Anthracite Black (RAL 7021), Chrome.

Dimensions

Oslo Bar Stool	
Height:	103,5 cm / 40.8"
Width:	51 cm / 20.08"
Depth:	55 cm / 21.7"
Seat height:	78 cm / 30.70"
Seat depth:	44 cm / 17.32"

Oslo Counter Stool

Height:	93,5 cm / 36.8"
Width:	51 cm / 20.08"
Depth:	55 cm / 21.7"
Seat height:	68 cm / 26.77"
Seat depth:	44 cm / 17.32"



*Valid for a large selection of Kvadrat upholstery. VOC CDPH 01350 and BIFMA X7.1 are not valid for UK items.

oslo lounge chair

by Anderssen & Voll

Marrying its compact design with comfort and elegance, the Oslo Lounge Chair offers an inviting and dynamic seat with a classic yet distinctly modern expression. A low and deep shell, elevated by an embracing back that envelops and supports, makes it an equally ideal piece for the contemporary home, hotel room, office lounge, or lobby.



Oslo Lounge Chair
— Swivel Base

Materials

Seat and back in molded PU foam with embedded steel and wood frame. Textile, imitation leather, or leather upholstery. Swivel base in powder coated steel. Plastic gliders.

Certificates & Warranty

Strength & Stability: EN 16139 - L2, BIFMA X5.4.
Eco Labels & Safety: Declare Red List approved*, VOC CDPH 01350* and BIFMA X7.1*, Crib 5 upon request.
Warranty: 10 years

Color Options & Codes

Upholstery: Textile, imitation leather, or leather. See the wide selection in our digital Product Configurator and visit our Price List for a full overview.
Legs: Black (RAL 9011), Grey (7044).

Ready-To-Ship Options

Upholstery / Base

Vidar 146 / Grey	
Twill Weave 990 / Black	

Dimensions

Width:	82,5 cm / 32.48"
Height:	75,5 cm / 29.72"
Depth:	67,5 cm / 26.57"
Seat height:	40 cm / 15.75"
Seat depth:	54 cm / 21.26"



Oslo Lounge Chair
— Tube Base

Materials

Seat and back in molded PU foam with embedded steel and wood frame. Textile, imitation leather, or leather upholstery. Tube base in powder coated steel. Plastic gliders.

Certificates & Warranty

Strength & Stability: EN 16139 - L2, BIFMA X5.4.
Eco Labels & Safety: Declare Red List approved*, VOC CDPH 01350* and BIFMA X7.1*, Crib 5 upon request.
Warranty: 10 years

Color Options & Codes

Upholstery: Textile, imitation leather, or leather. See the wide selection in our digital Product Configurator and visit our Price List for a full overview.
Legs: Black (RAL 9011), Grey (7044).

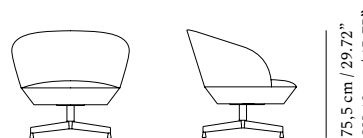
Ready-To-Ship Options

Upholstery / Base

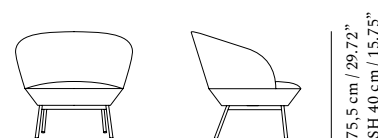
Vidar 146 / Grey	
Twill Weave 990 / Black	

Dimensions

Width:	82,5 cm / 32.48"
Height:	75,5 cm / 29.72"
Depth:	67,5 cm / 26.57"
Seat height:	40 cm / 15.75"
Seat depth:	54 cm / 21.26"



W 82,5 cm / 32.48" D 67,5 cm / 26.57"



W 82,5 cm / 32.48" D 67,5 cm / 26.57"

*Valid for a large selection of Kvadrat upholstery.

oslo sofa

by Anderssen & Voll

The Oslo Sofa is available in three sizes alongside a Bench and a Pouf, all designed with sculptural, geometric lines for a sophisticated expression, paired with their soft seat and enveloping back. The design's playful lines bring elegant comfort to any lounging setting, whether for the hotel room, lobby, or office lounge area.



Configurable

Oslo Sofa
— 3-Seater

Materials

Inner frame of steel and molded foam with zig-zag springs. Textile, imitation leather, or leather upholstery. Base in chrome or powder coated steel.

Certificates & Warranty

Strength & Stability: EN 16139 - L2, EN 1022, BIFMA X5.4.
Eco Labels & Safety: Declare Red list approved*, VOC CDPH 01350* and BIFMA X7.1*, Crib 5 upon request.
Warranty: 10 years

Color Options & Codes

Upholstery: Textile, imitation leather, or leather. See the wide selection in our digital Product Configurator and visit our Price List for a full overview.
Legs: Black (RAL 9011), Dark Grey (RAL 7026), Grey (RAL 7044), Chrome.

Dimensions

Width:	200 cm / 78.75"
Height:	79,5cm / 31.3"
Depth:	73 cm / 28.75"
Seat height:	45 cm / 17.72"
Seat depth:	54cm / 21.3"



Configurable

Oslo Sofa
— 2-Seater

Materials

Inner frame of steel and molded foam with zig-zag springs. Textile, imitation leather, or leather upholstery. Base in chrome or powder coated steel.

Certificates & Warranty

Strength & Stability: EN 16139 - L2, EN 1022, BIFMA X5.4.
Eco Labels & Safety: Declare Red list approved*, VOC CDPH 01350* and BIFMA X7.1*, Crib 5 upon request.
Warranty: 10 years

Color Options & Codes

Upholstery: Textile, imitation leather, or leather. See the wide selection in our digital Product Configurator and visit our Price List for a full overview.
Legs: Black (RAL 9011), Dark Grey (RAL 7026), Grey (RAL 7044), Chrome.

Dimensions

Width:	150 cm / 59"
Height:	79,5cm / 31.3"
Depth:	73 cm / 28.75"
Seat height:	45 cm / 17.72"
Seat depth:	54cm / 21.3"



Configurable

Oslo Sofa
— 1-Seater

Materials

Inner frame of steel and molded foam with zig-zag springs. Textile, imitation leather, or leather upholstery. Base in chrome or powder coated steel.

Certificates & Warranty

Strength & Stability: EN 16139 - L2, EN 1022, BIFMA X5.4.
Eco Labels & Safety: Declare Red list approved*, VOC CDPH 01350* and BIFMA X7.1*, Crib 5 upon request.
Warranty: 10 years

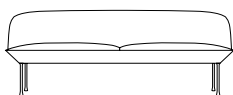
Color Options & Codes

Upholstery: Textile, imitation leather, or leather. See the wide selection in our digital Product Configurator and visit our Price List for a full overview.
Legs: Black (RAL 9011), Dark Grey (RAL 7026), Grey (RAL 7044), Chrome.

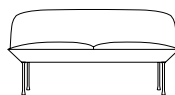
Dimensions

Width:	80 cm / 31.5"
Height:	79,5cm / 31.3"
Depth:	73 cm / 28.75"
Seat height:	45 cm / 17.72"
Seat depth:	54cm / 21.3"

*Valid for a large selection of Kvadrat upholstery.



W 200 cm / 78.75"



W 150 cm / 59"



W 80 cm / 31.5"



D 73 cm / 28.75"

H 78 cm / 30.75"
SH 45 cm / 17.72"



Oslo Bench

Materials

Inner frame of steel and molded foam with zig-zag springs. Textile, imitation leather, or leather upholstery. Base in chrome or powder coated steel.

Certificates & Warranty

Strength & Stability: EN 16139 - L2, EN 1022, BIFMA X5.4.
Eco Labels & Safety: Declare Red list approved*, VOC CDPH 01350* and BIFMA X7.1*, Crib 5 upon request.
Warranty: 10 years

Color Options & Codes

Upholstery: Textile, imitation leather, or leather. See the wide selection in our digital Product Configurator and visit our Price List for a full overview.
Legs: Black (RAL 9011), Dark Grey (RAL 7026), Grey (RAL 7044), Chrome.

Dimensions

Width:	150 cm / 59"
Height:	45 cm / 17.72"
Depth:	73 cm / 28.75"



Oslo Pouf

Materials

Inner frame of steel and molded foam with zig-zag springs. Textile, imitation leather, or leather upholstery. Base in chrome or powder coated steel.

Certificates & Warranty

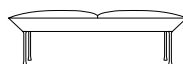
Strength & Stability: EN 16139 - L2, EN 1022, BIFMA X5.4.
Eco Labels & Safety: Declare Red list approved*, VOC CDPH 01350* and BIFMA X7.1*, Crib 5 upon request.
Warranty: 10 years

Color Options & Codes

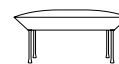
Upholstery: Textile, imitation leather, or leather. See the wide selection in our digital Product Configurator and visit our Price List for a full overview.
Legs: Black (RAL 9011), Dark Grey (RAL 7026), Grey (RAL 7044), Chrome.

Dimensions

Width:	100 cm / 39.5"
Height:	45 cm / 17.72"
Depth:	73 cm / 28.75"



W 150 cm / 59"



W 100 cm / 39.5"



H 45 cm / 17.72"

D 73 cm / 28.75"

*Valid for a large selection of Kvadrat upholstery.

cover armchair

by Thomas Bentzen

The Cover Armchair brings a new perspective to the iconic Scandinavian wooden chair. With its sturdy frame in solid wood and elegantly curved backrest in veneer, the design has a refined and inviting expression. Ideal for both low-key and high-end dining settings where extensive comfort is needed.



Cover Armchair
— Shell

Materials

Oak and Stained Dark Brown versions: Back, seat and armrest in oak veneer, solid oak frame and legs. Slight color variation can occur. Colored versions: Back, seat and armrest in ash veneer, frame and legs in solid beech wood. All with water-based lacquer. Plastic glides.

Certificates & Warranty

Strength & Stability: EN 16139 - L2, EN 1022, BIFMA X5.4. **Eco Labels & Safety:** Declare Red list approved, GreenTag Level C, VOC CDPH 01350 and BIFMA X7.1, EU Ecolabel.
Warranty: 10 years

Options

Felt glides.

Color Options & Codes

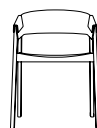
Oak, Stained Dark Brown, Black (RAL 9017), Green (NCS S 6010-G10Y), Dark Beige (NCS S 4010-Y10R).

Ready-To-Ship Options

Oak	
Black	
Green	
Stained Dark Brown	
Dark Beige	

Dimensions

Height:	75.8 cm / 29.8"
Width:	56.2 cm / 22.1"
Depth:	49.8 cm / 19.6"
Seat height:	46 cm / 18"
Seat width:	45.3 cm / 17.8"
Seat depth:	36.8 cm / 14.5"
Armrest height:	65.6 cm / 25.8"



W 56,5 cm / 22.25"



Cover Armchair
— Seat Upholstery

Materials

Oak and Stained Dark Brown versions: Back, seat and armrest in oak veneer, solid oak frame and legs. Slight color variation can occur. Colored versions: Back, seat and armrest in ash veneer, frame and legs in solid beech wood. All with water-based lacquer. Textile or leather upholstered seat. Plastic glides.

Certificates & Warranty

Strength & Stability: EN 16139 - L2, EN 1022, BIFMA X5.4. **Eco Labels & Safety:** Declare Red list approved*, GreenTag Level C**, VOC CDPH 01350* and BIFMA X7.1*, Crib 5 upon request.
Warranty: 10 years

Options

Felt glides.

Color Options & Codes

Upholstery: Textile, leather. See the wide selection in our digital Product Configurator and visit our Price List for a full overview.

Frame: Oak, Stained Dark Brown, Black (RAL 9017), Green (NCS S 6010-G10Y), Dark Beige (NCS S 4010-Y10R).

Ready-To-Ship Options

Seat Upholstery / Frame	
Refine Leather Cognac / Oak	
Refine Leather Black / Black	

Dimensions

Height:	75.8 cm / 29.8"
Width:	56.2 cm / 22.1"
Depth:	49.8 cm / 19.6"
Seat height:	46 cm / 18"
Seat width:	45.3 cm / 17.8"
Seat depth:	36.8 cm / 14.5"
Armrest height:	65.6 cm / 25.8"



D 46 cm / 18"

H 76 cm / 30"
SH 46 cm / 18"

*Valid for a large selection of Kvadrat upholstery, Refine and Easy leather.
**Valid for a large selection of Kvadrat upholstery.

cover side chair

by Thomas Bentzen

Referencing the values of forward-thinking craftsmanship, the Cover Side Chair is an elegant perspective on the timeless wooden chair. With its curved backrest in the veneer that folds elegantly around its back legs and ties the design together, the Cover Side Chair explores deep comfort and a sturdy base in solid wood. Stack up to four non-upholstered or seat upholstered Cover Side Chairs on the floor or ten on the Trolley.



Configurable

Cover Side Chair
— Shell

Materials

Back and seat in oak veneer, solid oak frame and legs. Water-based lacquer. Stacking Pad in felt made from 60% post-consumer recycled content. For Oak and Stained Dark Brown versions slight color variation can occur. Plastic glides.

Certificates & Warranty

Strength & Stability: EN 16139 - L2, EN 1022, BIFMA X5.4. **Eco Labels & Safety:** GreenTag Level C, VOC CDPH 01350 and BIFMA X7.1, EU Ecolabel. **Warranty:** 10 years






Options

Felt glides. Trolley.

Color Options & Codes

Oak, Stained Dark Brown, Black (RAL 9017), Green (NCS S 6010-G10Y), Dark Beige (NCS S 4010-Y10R)

Ready-To-Ship Options

Oak	
Black	
Green	
Stained Dark Brown	
Dark Beige	

Dimensions

Height:	75,4 cm / 29.7"
Width:	53,6 cm / 21.1"
Depth:	48,9 cm / 19.3"
Seat height:	45,4 cm / 17.9"
Seat width:	45,3 cm / 17.8"
Seat depth:	36 cm / 14.2"



Configurable

Cover Side Chair
— Seat Upholstery

Materials

Back and seat in oak veneer, solid oak frame and legs. Water-based lacquer. Stacking Pad in felt made from 60% post-consumer recycled content. Textile or leather upholstered seat. For Oak and Stained Dark Brown versions slight color variation can occur. Plastic glides.

Certificates & Warranty

Strength & Stability: EN 16139 - L2, EN 1022, BIFMA X5.4. **Eco Labels & Safety:** GreenTag Level C**, VOC CDPH 01350* and BIFMA X7.1*, Crib 5 upon request. **Warranty:** 10 years

Options

Felt glides. Trolley.



Color Options & Codes

Upholstery: Textile, leather. See the wide selection in our digital Product Configurator and visit our Price List for a full overview.

Frame: Oak, Stained Dark Brown, Black (RAL 9017), Green (NCS S 6010-G10Y), Dark Beige (NCS S 4010-Y10R)

Ready-To-Ship Options

Seat Upholstery / Frame

Refine Leather Cognac / Oak	
Refine Leather Black / Black	

Dimensions

Height:	75,4 cm / 29.7"
Width:	53,6 cm / 21.1"
Depth:	48,9 cm / 19.3"
Seat height:	45,4 cm / 17.9"
Seat width:	45,3 cm / 17.8"
Seat depth:	36 cm / 14.2"



Trolley
— Cover Side Chair

A trolley for Cover Side Chair that allows for easy storage and movement of multiple chairs at a time. The trolley can withstand a weight of 120 kg / 265 lb. Stack up to 10 non-upholstered or upholstered Cover Side Chair.

*Valid for a large selection of Kvadrat upholstery. Refine and Easy leather.
**Valid for a large selection of Kvadrat upholstery.



W 53,6 cm / 21.1"

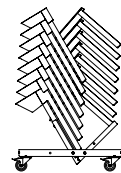


D 48,9 cm / 19.3"

H 75,4 cm / 29.7"
SH 45,4 cm / 17.9"



W 57 cm / 22.5"



D 90 cm / 35.5"

cover bar & counter stool

by Thomas Bentzen

The Cover Bar & Counter Stool challenges the possibilities of veneer through a forward-thinking approach, echoing Scandinavian design ideas. The design is lightweight and features a tall, enveloping back for extensive comfort that allows one to be seated for hours on end, for dinner, a drink, or even working at a counter desk.

130

seating



Cover Bar & Counter Stool
— Shell

Materials

Back and seat in oak veneer, solid oak frame and legs. Made using FSC™-certified wood. Water-based lacquer. For Oak and Stained Dark Brown versions slight color variation can occur. Plastic glides.

Certificates & Warranty

Strength & Stability: EN 16139 - L2, EN 1022, BIFMA X5.4. **Eco Labels & Safety:** Declare Red list approved, VOC CDPH 01350 and Bifma X7.1, FSC™, EU Ecolabel.

Warranty: 10 years






Options

Felt glides. Steel footrest protector.

Color Options & Codes

Oak, Stained Dark Brown, Black (RAL 9017), Green (NCS S 6010-G10Y), Dark Beige (NCS S 4010-Y10R).

Ready-To-Ship Options

Oak	
Black	
Green	
Stained Dark Brown	
Dark Beige	

Dimensions

Cover Bar Stool

Height:	106 cm / 41.7"
Width:	50 cm / 19.7"
Depth:	58 cm / 22.8"
Seat height:	75 cm / 29.5"
Seat width:	45,3 cm / 17.8"

Cover Counter Stool

Height:	96 cm / 37.8"
Width:	50 cm / 19.7"
Depth:	55 cm / 21.6"
Seat height:	65 cm / 25.6"
Seat width:	45,3 cm / 17.8"

Cover Bar & Counter Stool
— Seat Upholstery

Materials

Back and seat in oak veneer, solid oak frame and legs. Made using FSC™-certified wood. Water-based lacquer. Textile or leather upholstered seat. For Oak and Stained Dark Brown versions slight color variation can occur. Plastic glides.

Certificates & Warranty

Strength & Stability: EN 16139 - L2, EN 1022, BIFMA X5.4. **Eco Labels & Safety:** Declare Red list approved, GreenTag Level C™, VOC CDPH 01350 and BIFMA X7.1, FSC™, Crib 5 upon request.

Warranty: 10 years

Options

Felt glides. Steel footrest protector.



Color Options & Codes

Upholstery: Textile, leather. See the wide selection in our digital Product Configurator and visit our Price List for a full overview.

Frame: Oak, Stained Dark Brown, Black (RAL 9017), Green (NCS S 6010-G10Y), Dark Beige (NCS S 4010-Y10R)

Ready-To-Ship Options

Seat Upholstery / Frame

Refine Leather Cognac / Oak	
Refine Leather Black / Black	

Dimensions

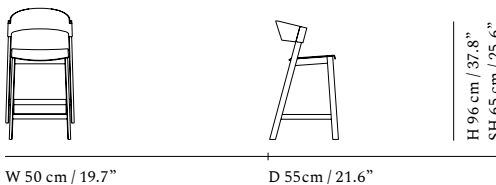
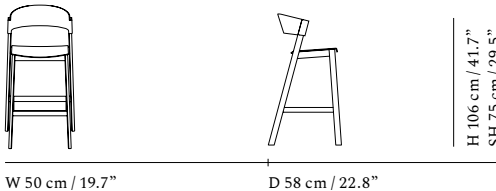
Cover Bar Stool

Height:	106 cm / 41.7"
Width:	50 cm / 19.7"
Depth:	58 cm / 22.8"
Seat height:	75 cm / 29.5"
Seat width:	45,3 cm / 17.8"

Cover Counter Stool

Height:	96 cm / 37.8"
Width:	50 cm / 19.7"
Depth:	55 cm / 21.6"
Seat height:	65 cm / 25.6"
Seat width:	45,3 cm / 17.8"

*Valid for a large selection of Kvadrat upholstery.
Refine and Easy leather.
**Valid for a large selection of Kvadrat upholstery.



cover lounge chair

by Thomas Bentzen

The Cover Lounge Chair combines Scandinavian craftsmanship with a modern expression for an elegantly deep lounging design. It has a grand seat alongside the details of its curved back and wooden armrest covers. Place the design in sofa settings, on its own, or in pairs throughout lounge areas.



Cover Lounge Chair
— Shell

Materials

Back and seat in oak veneer, solid oak frame and legs. Water-based lacquer. For Oak and Stained Dark Brown versions slight color variation can occur. Plastic glides.

Certificates & Warranty

Strength & Stability: EN 16139 - L2, EN 1022, BIFMA X5.4. **Eco Labels & Safety:** GreenTag Level C, VOC CDPH 01350 and BIFMA X7.1, EU Ecolabel. **Warranty:** 10 years




Options

Felt glides.

Color Options & Codes

Oak, Stained Dark Brown, Black (NCS S 9000-N), Dark Beige (NCS S 4010-Y10R).

Ready-To-Ship Options

Oak	
Black	
Stained Dark Brown	

Dimensions

Height:	70,7 cm / 27.8"
Width:	66,3 cm / 26.1"
Depth:	61,2 cm / 24.1"
Seat height:	38,1 cm / 15.0"
Seat width:	54,4 cm / 21.4"
Seat depth:	48,8 cm / 19.2"
Armrest height:	57,8 cm / 22.8"



W 66,3 cm / 26.1"



Cover Lounge Chair
— Seat Upholstery

Materials

Back and seat in oak veneer, solid oak frame and legs. Water-based lacquer. Textile or leather upholstered seat. For Oak and Stained Dark Brown versions slight color variation can occur. Plastic glides.

Certificates & Warranty

Strength & Stability: EN 16139 - L2, EN 1022, BIFMA X5.4. **Eco Labels & Safety:** GreenTag Level C**, VOC CDPH 01350* and BIFMA X7.1*, Crib 5 upon request. **Warranty:** 10 years

Options

Felt glides.



Color Options & Codes

Upholstery: Textile, leather. See the wide selection in our digital Product Configurator and visit our Price List for a full overview.

Frame: Oak, Stained Dark Brown, Black (NCS S 9000-N), Dark Beige (NCS S 4010-Y10R).

Ready-To-Ship Options

Seat Upholstery / Frame

Refine Leather Cognac / Oak	
Refine Leather Black / Black	

Dimensions

Height:	70,7 cm / 27.8"
Width:	66,3 cm / 26.1"
Depth:	61,2 cm / 24.1"
Seat height:	38,1 cm / 15.0"
Seat width:	54,4 cm / 21.4"
Seat depth:	48,8 cm / 19.2"
Armrest height:	57,8 cm / 22.8"



D 61,2 cm / 24.1"

H 70,7 cm / 27.8"
SH 38,1 cm / 15"

*Valid for a large selection of Kvadrat upholstery. Refine and Easy leather.
**Valid for a large selection of Kvadrat upholstery.

loft chair

by Thomas Bentzen

The Loft Chair combines Scandinavian design with industrial references for a modern, durable design. The design features contrasting material with its frame in powder coated steel that is offset by the soft plywood on the seat and back, molded to embrace the user's body.

132



Loft Chair

Materials

Back and seat in veneer with a beech core and an oak veneer top with water-based lacquer. For Oak and Stained Dark Brown versions slight color variation can occur. Frame in powder coated steel. Plastic glides.

Certificates & Warranty

Strength & Stability: EN 16139 - L2, EN 1022, BIFMA X5.4. **Eco Labels & Safety:** Declare Red list approved, VOC CDPH 01350 and BIFMA X7.1. **Warranty:** 10 years

Options

Felt glides.




Color Options & Codes

Seat & Back: Oak, Stained Dark Brown, Black (RAL 9005).

Base: Black (RAL 9005), Grey (RAL 7044), Dusty Green (RAL 7033), Deep Red (RAL 8015).

Ready-To-Ship Options

Shell / Base

Black / Black	 
Oak / Black	 
Oak / Grey	 
Oak / Dusty Green	 
Oak / Deep Red	 
Stained Dark Brown / Black	 

Dimensions

Height:	78.7 cm / 31"
Width:	42.4 cm / 16.7"
Depth:	48.8 cm / 19.2"
Seat height:	46 cm / 18"
Seat depth:	40.9 cm / 16.1"



Loft Chair

— Seat Upholstery

Materials

Back and seat in veneer with a beech core and an oak veneer top with water-based lacquer. For Oak and Stained Dark Brown versions slight color variation can occur. Textile, imitation leather, or leather upholstered seat. Frame in powder coated steel. Plastic glides.

Certificates & Warranty

Strength & Stability: EN 16139 - L2, EN 1022, BIFMA X5.4. **Eco Labels & Safety:** Declare Red list approved*, VOC CDPH 01350* and BIFMA X7.1*, Crib 5 upon request. **Warranty:** 10 years

Options

Felt glides.

Color Options & Codes

Upholstery: Textile, imitation leather, or leather. See the wide selection in our digital Product Configurator and visit our Price List for a full overview.

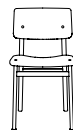
Seat & Back: Oak, Stained Dark Brown, Black (RAL 9005).

Base: Black (RAL 9005), Grey (RAL 7044), Dusty Green (RAL 7033), Deep Red (RAL 8015).

Dimensions

Height:	78,5 cm / 31"
Width:	42,5 cm / 16.75"
Depth:	48,8 cm / 19.2"
Seat height:	46 cm / 18"
Seat depth:	40,9 cm / 16.1"

*Valid for a large selection of Kvadrat upholstery, Refine and Easy leather.



W 42,5 cm / 16.75"



D 48,8 cm / 19.2"

H 78,5 cm / 31"
SH 46 cm / 18"

loft bar & counter stool

by Thomas Bentzen

Loft Bar & Counter Stool join industrial references with Scandinavian design through a combination of plywood and steel. Though having a small footprint, the design has a full seat and back width to provide maximum comfort to its user while having a unique expression. The cast frame is welded to give stability and added durability to the chair.



Loft Bar & Counter Stool

Materials

Back and seat in veneer with a beech core and an oak veneer top with water-based lacquer. For Oak and Stained Dark Brown versions slight color variation can occur. Frame in powder coated steel. Plastic glides.

Certificates & Warranty

Strength & Stability: EN 16139 - L2, EN 1022, BIFMA X5.4. **Eco Labels & Safety:** Declare Red list approved, VOC CDPH 01350 and BIFMA X7.1.

Warranty: 10 years

Options

Felt glides.


Color Options & Codes

Seat & Back: Oak, Stained Dark Brown, Black (RAL 9005).

Base: Black (RAL 9005), Grey (RAL 7044), Dusty Green (RAL 7033), Deep Red (RAL 8015).

Ready-To-Ship Options

Shell / Base

Black / Black	 
Oak / Black	 
Oak / Grey	 
Oak / Dusty Green	 
Oak / Deep Red	 
Stained Dark Brown / Black	 

Dimensions

Loft Bar Stool

Height:	108.4cm / 42.7"
Width:	43,5 cm / 17.25"
Depth:	49 cm / 19.25"
Seat height:	75.6cm / 29.8"
Seat depth:	40,9 cm / 16.1"

Loft Counter Stool

Height:	98.4cm / 38.7"
Width:	42.4cm / 16.7"
Depth:	48.8cm / 19.2"
Seat height:	65.6cm / 25.8"
Seat depth:	40,9 cm / 16.1"



Loft Bar & Counter Stool

— Seat Upholstery

Materials

Back and seat in veneer with a beech core and an oak veneer top with water-based lacquer. For Oak and Stained Dark Brown versions slight color variation can occur. Textile, imitation leather, or leather upholstered seat. Frame in powder coated steel. Plastic glides.

Certificates & Warranty

Strength & Stability: EN 16139 - L2, EN 1022, BIFMA X5.4. **Eco Labels & Safety:** Declare Red list approved*, VOC CDPH 01350* and BIFMA X7.1*, Crib 5 upon request.

Warranty: 10 years

Options

Felt glides.

Color Options & Codes

Upholstery: Textile, imitation leather, or leather. See the wide selection in our digital Product Configurator and visit our Price List for a full overview.

Seat & Back: Oak, Stained Dark Brown, Black (RAL 9005). **Base:** Black (RAL 9005), Grey (RAL 7044), Dusty Green (RAL 7033), Deep Red (RAL 8015).

Dimensions

Loft Bar Stool

Height:	108,5 cm / 42.75"
Width:	43,5 cm / 17.25"
Depth:	49 cm / 19.25"
Seat height:	75 cm / 29.5"
Seat depth:	40,9 cm / 16.1"

Loft Counter Stool

Height:	98,5 cm / 38.75"
Width:	42,5 cm / 16.75"
Depth:	49 cm / 19.25"
Seat height:	65 cm / 25.5"
Seat depth:	40,9 cm / 16.1"



W 43,5 cm / 17.25"



D 49 cm / 19.25"

*Valid for a large selection of Kvadrat upholstery, Refine and Easy leather.

H 108,5 cm / 42.75"
SH 75 cm / 29.5"



W 42,5 cm / 16.75"



D 49 cm / 19.25"

H 98,5 cm / 38.75"
SH 65 cm / 25.5"

workshop chair & bench

by Cecilie Manz

The Workshop Chair and Bench combine the values of Scandinavian craftsmanship with a modernly understated expression through subtle details: its curved back and seat for optimal comfort, the natural grain of the wood, and its elegant compact proportions.



Workshop Chair*

Materials

Seat and back in oak veneer, frame and legs in solid oak. All parts in a water-based lacquer. For Oak versions slight color variation can occur. Plastic glides.

Certificates & Warranty

Strength & Stability*: EN 16139 - L2, EN 1022.

Eco Labels & Safety: VOC CDPH 01350 and BIFMA X7.1.

Warranty: 5 years

Options

Felt glides.

Color Options & Codes

Oak, Black (RAL 9005).

Ready-To-Ship Options

Oak	
Black	

Dimensions

Height:	79 cm / 31"
Width:	40 cm / 15.75"
Depth:	46 cm / 18"
Seat height:	45 cm / 17.75"
Seat depth:	38,9 cm / 15.3"



Workshop Bench

Materials

Frame and legs in solid oak, seat and back in form pressed oak veneer — all parts in FSC™-certified wood and coated with a water-based lacquer. For Oak versions slight color variation can occur. Plastic glides.

Certificates & Warranty

Strength & Stability: EN 1022, EN 16139-L2. Eco Labels

& Safety: VOC CDPH 01350 and BIFMA X7.1, FSC™

Warranty: 5 years

Options

Felt glides.

Color Options & Codes

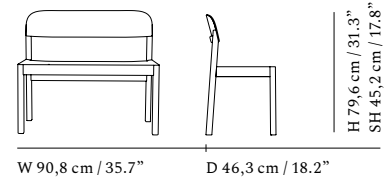
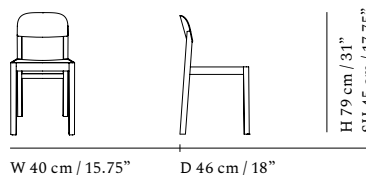
Oak, Black (RAL 9005).

Ready-To-Ship Options

Oak	
Black	

Dimensions

Height:	79,6 cm / 31.3"
Width:	90,8 cm / 35.7"
Depth:	46,3 cm / 18.2"
Seat height:	45,2 cm / 17.8"
Seat depth:	38,9 cm / 15.3"



*The Workshop Chair is not recommended for heavy use contract projects.

nerd chair, bar & counter stool

by David Geckeler

With seamless integration of its back and seat, the Nerd Chair Series has a playful and unique expression. The design allows the user to be seated at various angles alongside the slightly curved back through its curved seat.



Nerd Chair

Materials

Oak and Stained Dark Brown version: seat and back in form pressed oak veneer. Slight color variation can occur. Legs in solid oak. Colored version: seat and back in form pressed ash veneer. Legs in solid ash. All parts in water-based lacquer. Plastic glides.

Certificates & Warranty

Strength & Stability: EN 16139 - L2, EN 1022. **Eco Labels & Safety:** Declare Red list approved, GreenTag Level C, VOC CDPH 01350 and BIFMA X7.1.

Warranty: 5 years

Options

Felt glides.

Color Options & Codes

Oak, Stained Dark Brown, Green (NCS S 6020-G), Grey (Ral 7040), Black (RAL 9017), Midnight Blue (RAL 5004), Tan Rose (NCS S2030-Y80R).

Ready-To-Ship Options

Oak	
Green	
Grey	
Black	
Midnight Blue	
Tan Rose	
Stained Dark Brown	

Dimensions

Height:	79 cm / 31"
Width:	45,5 cm / 17.9"
Depth:	51,5 cm / 20.3"
Seat height:	47 cm / 18.5"
Seat depth:	41,5 cm / 16.3"



Nerd Bar & Counter Stool

Materials

Oak and Stained Dark Brown version: seat and back in form pressed oak veneer. Slight color variation can occur. Legs in solid oak. Colored version: seat and back in form pressed ash veneer. Legs in solid ash. All parts in water-based lacquer. Plastic glides.

Certificates & Warranty

Strength & Stability: EN 16139 - L2, EN 1022. **Eco Labels & Safety:** Declare Red list approved, GreenTag Level C, VOC CDPH 01350 and BIFMA X7.1.

Warranty: 5 years

Options

Felt glides. Steel foot protection.

Color Options & Codes

Oak, Stained Dark Brown, Green (NCS S 6020-G), Grey (Ral 7040), Black (RAL 9017), Midnight Blue (RAL 5004), Tan Rose (NCS S2030-Y80R).

Ready-To-Ship Options

Oak	
Green	
Grey	
Black	
Midnight Blue	
Tan Rose	
Stained Dark Brown	

Dimensions

Height:	89 cm / 35"
Seat height:	75 cm / 29.5"
Width:	44 cm / 17.3"
Depth:	45 cm / 17.7"
Seat width:	40,5 cm / 15.9"

Nerd Counter Stool

Height:	79 cm / 31"
Seat height:	65 cm / 25.5"
Width:	41,5 cm / 16.3"
Depth:	42,5 cm / 16.7"
Seat width:	40,5 cm / 15.9"

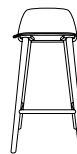


W 45,5 cm / 17.9"



D 50 cm / 19.75"

H 79 cm / 31"
SH 46 cm / 18"



W 44 cm / 17.3"



D 45 cm / 17.7"

H 89 cm / 35"
SH 75 cm / 29.5"



W 41,5 cm / 16.3"



D 42,5 cm / 16.7"

H 79 cm / 31"
SH 65 cm / 25.5"

The Visu Chair Family brings a new perspective to the iconic wooden chair through its elegant shape in form-pressed wood veneer, echoing Scandinavian design ideas together with a contemporary expression. The subdued and timeless character adds feelings of modern familiarity alongside a comfortable seat, combining the family's designs while complementing their surroundings.

136

visu chair



family

by Mika Tolvanen

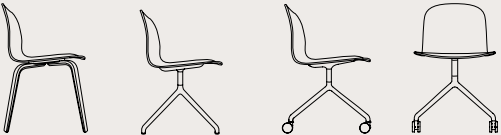
Explore the
Visu Chair Family



Spanning across chairs, bar & counter stools, and lounge chairs, the Visu Chair Family comes in a variety of bases, sizes, and colors with many possibilities for customization through colored bases and upholsteries in both textile and leather, allowing for the design to fit within any professional project.



Chair
Wood Base, Tube Base, Sled Base



Wide Chair
Wood Base, Swivel Base, Swivel Base w. Castors



Bar & Counter Stool
Wood Base



Lounge Chair
Wood Base

visu chair

by Mika Tolvanen

The Visu Chair combines ergonomic and functional expressions with a quiet silhouette, bringing a new perspective to the wooden chair. With its numerous bases and shell finishes, the design is ideal for conferences, office spaces, restaurants, or home dining areas.



Wood Base — Shell

Materials
Oak versions: form pressed oak veneer shell and base. Slight color variation can occur. Colored versions: form pressed ash veneer shell and base. All in water-based lacquer. Plastic glides.

Certificates & Warranty
Strength & Stability: EN 16139 - L2, EN 1022.
Eco Labels & Safety: Declare Red list approved, GreenTag Level C, VOC CDPH 01350 and BIFMA X7.1.
Warranty: 5 years

Options
Felt glides.

Color Options & Codes
Shell & Base: Oak, White* (RAL 9016), Black (RAL 9017), Grey (RAL 7040), Dusty Green (NCS S 4010-G50Y), Dark Green (RAL 6012), Tan Rose (NCS S 2030-Y80R), Midnight Blue (RAL 5004), Sand (NCS 2010-Y10R).
*Not available as base color

Ready-To-Ship Options

Shell / Base

Oak	
White / Oak	
Black	
Grey	
Dusty Green	
Dark Green	
Tan Rose	
Midnight Blue	
Sand	

Dimensions
Height: 80 cm / 31.5"
Width: 46 cm / 18"
Depth: 50 cm / 19.7"
Seat height: 46 cm / 18"
Seat depth: 41cm / 16.1"
Seat width: 42,5 cm / 16.75"

Wood Base — Full Upholstery

Materials
Oak versions: form pressed oak veneer shell and base. Slight color variation can occur. Colored versions: form pressed ash veneer shell and base. All in water-based lacquer. Shell with foam and fully upholstered with textile or leather. Plastic glides.

Certificates & Warranty
Strength & Stability: EN 16139 - L2, EN 1022.
Eco Labels & Safety: Declare Red list approved, GreenTag Level C**, VOC CDPH 01350* and BIFMA X7.1*, Crib 5 upon request.
Warranty: 5 years

Options
Felt glides.

Color Options & Codes
Upholstery: Textile, leather. See the wide selection in our digital Product Configurator and visit our Price List for a full overview.
Base: Oak, Black (RAL 9017), Grey (RAL 7040), Dusty Green (NCS S 4010-G50Y), Dark Green (RAL 6012), Tan Rose (NCS S 2030-Y80R), Midnight Blue (RAL 5004), Sand (NCS 2010-Y10R).

Dimensions
Height: 80 cm / 31.5"
Width: 46 cm / 18"
Depth: 50 cm / 19.7"
Seat height: 46 cm / 18"
Seat depth: 41cm / 16.1"
Seat width: 42,5 cm / 16.75"

*Valid for a large selection of Kvadrat upholstery, Refine and Easy leather.
**Valid for a large selection of Kvadrat upholstery.



W 46 cm / 18"



D 50 cm / 19.7"

H 80 cm / 31.5"
SH 46 cm / 18"



Tube Base
— Shell

Stack up to 15 non-upholstered Visu Chair Tube Base on floor (8 with Linking Device) or 17 on Trolley (15 with Linking Device).

Materials

Form-pressed veneer shell in water-based lacquer. For Oak and versions slight color variation can occur. Stacking pad in injection-molded plastic. Tube Base in powder coated or chrome steel. Plastic glides.

Certificates & Warranty

Strength & Stability: EN 16139 - L2, EN 1022. **Eco Labels & Safety:** Declare Red list approved, GreenTag Level C., VOC CDPH 01350 and BIFMA X7.1. **Warranty:** 10 years

Options

Felt glides. Linking Device. Hanger. Trolley.

Color Options & Codes

Shell: Oak, Black (RAL 9017), Grey (RAL 7040). **Base:** Black (RAL 9017), Grey (RAL 7040), Chrome.

Ready-To-Ship Options

Shell / Base

Black / Black



Dimensions

Height:	81 cm / 31.9"
Width:	55 cm / 21.7"
Depth:	52,5 cm / 20.7"
Seat height:	47 cm / 18.5"
Seat depth:	41 cm / 16.1"
Seat width:	42,5 cm / 16.7"



W 55 cm / 21.7"



Tube Base
— Full Upholstery

Stack up to 10 upholstered Visu Chair Tube Base on floor (8 with Linking Device) or 15 on Trolley (15 with Linking Device).

Materials

Form-pressed veneer with foam and fully upholstered in textile or leather. Stacking pad in injection-molded plastic. Tube base in powder coated or chrome steel. Plastic glides.

Certificates & Warranty

Strength & Stability: EN 16139 - L2, EN 1022. **Eco Labels & Safety:** Declare Red list approved, GreenTag Level C**, VOC CDPH 01350* and BIFMA X7.1*, Crib 5 upon request. **Warranty:** 10 years

Options

Felt glides. Linking Device. Hanger. Trolley.

Color Options & Codes

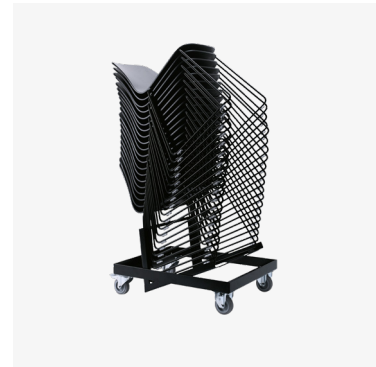
Upholstery: Textile, leather. See the wide selection in our digital Product Configurator and visit our Price List for a full overview. **Base:** Black (RAL 9017), Grey (RAL 7040), Chrome.

Dimensions

Height:	81 cm / 31.9"
Width:	55 cm / 21.7"
Depth:	52,5 cm / 20.7"
Seat height:	47 cm / 18.5"
Seat depth:	41 cm / 16.1"
Seat width:	42,5 cm / 16.7"



D 52,5 cm / 20.7"

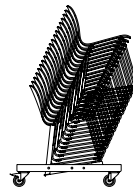


Trolley
— Visu Chair Tube & Sled Base

A trolley for Visu Chair Tube & Sled Base that allows for easy storage and movement of multiple chairs at a time. The Trolley can withstand a weight of 120 kg / 265 lb. Stack up to 17 non-upholstered Visu Tube & Sled Base (15 with Linking Device) or 15 upholstered (15 with Linking Device) on Trolley.



W 57 cm / 22.5"



D 90 cm / 35.5"

H 81 cm / 31.9"
SH 47 cm / 18.5"

H 52,7cm / 20.8"

visu chair

by Mika Tolvanen



Sled Base
— Shell

Stack up to 15 non-upholstered Visu Chair Tube Base on floor (8 with Linking Device) or 17 on Trolley (15 with Linking Device).

Materials
Form-pressed veneer shell in water-based lacquer. For Oak versions slight color variation can occur. Stacking pad in injection-molded plastic. Sled Base in powder coated steel. Plastic glides.

Certificates & Warranty
Strength & Stability: EN 16139 - L2, EN 1022, BIFMA X5.4, EN 15373-L2. **Eco Labels & Safety:** Declare Red list approved, GreenTag Level C., VOC CDPH 01350 and BIFMA X7.1.
Warranty: 10 years

Options
Felt glides. Linking Device. Hanger. Trolley.

Color Options & Codes
Shell: White (RAL 9016), Black (RAL 9017), Grey (RAL 7040). **Base:** Black (RAL 9017), Grey (RAL 7040), White (RAL 9016).

Ready-To-Ship Options
Shell / Base

Black / Black

Dimensions
Height: 78,5 cm / 30.9"
Width: 53 cm / 20.9"
Depth: 50 cm / 19.7"
Seat height: 45 cm / 17.7"
Seat depth: 41 cm / 16.1"
Seat width: 42,5cm / 16.7"



Sled Base
— Full Upholstery

Stack up to 10 upholstered Visu Chair Tube Base on floor (8 with Linking Device) or 15 on Trolley (15 with Linking Device).

Materials
Form-pressed veneer with foam and fully upholstered in textile or leather. Stacking pad in injection-molded plastic. Sled base in powder coated steel. Plastic glides.

Certificates & Warranty
Strength & Stability: EN 16139 - L2, EN 1022, BIFMA X5.4, EN 15373-L2. **Eco Labels & Safety:** Declare Red list approved, GreenTag Level C**, VOC CDPH 01350* and BIFMA X7.1*, Crib 5 upon request.
Warranty: 10 years

Options
Felt glides. Linking Device. Hanger. Trolley.

Color Options & Codes
Upholstery: Textile, leather. See the wide selection in our digital Product Configurator and visit our Price List for a full overview.
Base: Black (RAL 9017), Grey (RAL 7040), White (RAL 9016).

Dimensions
Height: 78,5 cm / 30.9"
Width: 53 cm / 20.9"
Depth: 50 cm / 19.7"
Seat height: 45 cm / 17.7"
Seat depth: 41 cm / 16.1"
Seat width: 42,5cm / 16.7"



Trolley
— Visu Chair Tube & Sled Base

A trolley for Visu Chair Tube & Sled Base that allows for easy storage and movement of multiple chairs at a time. The trolley can withstand a weight of 120 kg / 265 lb. Stack up to 17 non-upholstered Visu Tube & Sled Base (15 with Linking Device) or 15 upholstered (15 with Linking Device) on Trolley.

*Valid for a large selection of Kvadrat upholstery, Refine and Easy leather.
**Valid for a large selection of Kvadrat upholstery.



W 53 cm / 20.9"

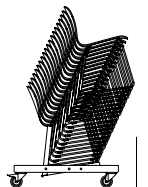


D 50 cm / 19.7"

H 78,5 cm / 30.9"
SH 45 cm / 17.7"



W 57 cm / 22.5"



D 90 cm / 35.5"

H 52,7 cm / 20.8"

visu wide chair

by Mika Tolvanen

Enhancing the comfort of the Visu family even further, the Visu Wide Chair features generous proportions and a simple expression. The design has a wide seat and back for added comfort, optimal for conference, office, or dining rooms.



Wood Base
— Shell

Materials

Form-pressed veneer shell and base, both in water-based lacquer. For Oak versions slight color variation can occur. Plastic glides.

Certificates & Warranty

Strength & Stability: EN 16139 - L2, EN 1022.

Eco Labels & Safety: GreenTag Level C, Declare Red list approved, VOC CDPH 01350 and BIFMA X7.1.
Warranty: 5 years

Options

Felt glides.

Color Options & Codes

Shell & Base: Oak, Black (RAL 9017).

Dimensions

Height:	78,5 cm / 31"
Width:	50 cm / 19.75"
Depth:	55 cm / 21.75"
Seat height:	46 cm / 18"
Seat width:	50 cm / 19.75"
Seat depth:	43 cm / 16.9"



Wood Base
— Full Upholstery

Materials

Form-pressed veneer with foam and fully upholstered with textile or leather. Form-pressed Wood Base in veneer with a water-based lacquer. For Oak versions slight color variation can occur. Plastic glides.

Certificates & Warranty

Strength & Stability: EN 16139 - L2, EN 1022. **Eco Labels & Safety:** GreenTag Level C**, VOC CDPH 01350* and BIFMA X7.1*, Crib 5 upon request.
Warranty: 5 years

Options

Felt glides.

Color Options & Codes

Upholstery: Textile, leather. See the wide selection in our digital Product Configurator and visit our Price List for a full overview.

Base: Oak, Black (RAL 9017).

Dimensions

Height:	78,5 cm / 31"
Width:	50 cm / 19.75"
Depth:	55 cm / 21.75"
Seat height:	46 cm / 18"
Seat width:	50 cm / 19.75"
Seat depth:	43 cm / 16.9"



W 50 cm / 19.75"



D 55 cm / 21.75"

H 78,5 cm / 31"
SH 46 cm / 18"

*Valid for a large selection of Kvadrat upholstery. Refine and Easy leather.
**Valid for a large selection of Kvadrat upholstery.

visu wide chair

by Mika Tolvanen

142

seating



Swivel Base & Swivel Base w. return
— Shell

Materials

Form-pressed veneer shell with water-based lacquer. For Oak versions slight color variation can occur. Swivel Base in die casted aluminum. Swivel foot casted in one piece. Plastic glides.

Certificates & Warranty

Strength & Stability: EN 16139 - L2, EN 1022.

Eco Labels & Safety: Declare Red list approved, VOC CDPH 01350 and BIFMA X7.1.

Warranty: 5 years

Options

Felt glides.

Color Options & Codes

Shell: Oak, Black (RAL 9017).

Base: Black (RAL 9017).

Dimensions

Height:	78,5 cm / 31"
Width:	50 cm / 19.75"
Depth:	55 cm / 21.75"
Seat height:	46 cm / 18"
Seat width:	50 cm / 19.75"
Seat depth:	43 cm / 16.9"



Swivel Base & Swivel Base w. return
— Full Upholstery

Materials

Form-pressed veneer with foam and fully upholstered with textile or leather. Swivel Base is die casted aluminum. Swivel foot is casted in one piece. Plastic glides.

Certificates & Warranty

Strength & Stability: EN 16139 - L2, EN 1022.

Eco Labels & Safety: Declare Red list approved, VOC CDPH 01350* and BIFMA X7.1*,

Crib 5 upon request.

Warranty: 5 years

Options

Felt glides.

Color Options & Codes

Upholstery: Textile, leather. See the wide selection in our digital Product Configurator and visit our Price List for a full overview.

Base: Black (RAL 9017).

Dimensions

Height:	78,5 cm / 31"
Width:	50 cm / 19.75"
Depth:	55 cm / 21.75"
Seat height:	46 cm / 18"
Seat width:	50 cm / 19.75"
Seat depth:	43 cm / 16.9"

*Valid for a large selection of Kvadrat upholstery, Refine and Easy leather.



W 50 cm / 19.75"



D 55 cm / 21.75"

H 78,5 cm / 31"
SH 46 cm / 18"



Swivel Base w. castors
— *Shell*

Materials

Form-pressed veneer shell with water-based lacquer. For Oak versions slight color variation can occur. Swivel Base is die casted aluminum. Swivel foot is casted in one piece. Castors.

Certificates & Warranty

Strength & Stability: EN 16139 - L2, EN 1022.
Eco Labels & Safety: Declare Red list approved, VOC CDPH 01350 and BIFMA X7.1.
Warranty: 5 years

Color Options & Codes

Shell: Oak, Black (RAL 9017).
Base: Black (RAL 9017) with Black castors.

Dimensions

Height: 78,5 cm / 31"
Width: 50 cm / 19.75"
Depth: 55 cm / 21.75"
Seat height: 46 cm / 18"
Seat width: 50 cm / 19.75"
Seat depth: 43 cm / 16.9"



Swivel Base w. castors
— *Full Upholstery*

Materials

Form-pressed veneer with foam and fully upholstered with textile or leather. Swivel Base is die casted aluminum. Swivel foot is casted in one piece. Castors.

Certificates & Warranty

Strength & Stability: EN 16139 - L2, EN 1022.
Eco Labels & Safety: Declare Red list approved, VOC CDPH 01350* and BIFMA X7.1*, Crib 5 upon request.
Warranty: 5 years

Color Options & Codes

Upholstery: Textile, leather. See the wide selection in our digital Product Configurator and visit our Price List for a full overview.
Base: Black (RAL 9017) with Black castors.

Dimensions

Height: 78,5 cm / 31"
Width: 50 cm / 19.75"
Depth: 55 cm / 21.75"
Seat height: 46 cm / 18"
Seat width: 50 cm / 19.75"
Seat depth: 43 cm / 16.9"



W 50 cm / 19.75"



D 55 cm / 21.75"

H 78,5 cm / 31"
SH 46 cm / 18"

*Valid for a large selection of Kvadrat upholstery. Refine and Easy leather.

visu bar & counter stool

by Mika Tolvanen

With its small curved back and long elegant legs, the Visu Bar & Counter Stool perfectly accompanies any restaurant bar or kitchen counter. The design features a steel footrest for added functionality and durability.

*Valid for a large selection of Kvadrat upholstery.
 **Refine and Easy leather.
 ***Valid for a large selection of Kvadrat upholstery.



W 42,4 cm / 16.7"



D 41,8 cm / 16.5"

H 89 cm / 35"
 SH 75 cm / 29.5"



W 41,3 cm / 16.3"



D 40,1 cm / 15.8"

H 79 cm / 31.1"
 SH 65 cm / 25.5"



Configurable

Wood Base
 — Shell

Materials

Oak and Stained Dark Brown version: Form pressed oak veneer shell and base. Slight color variation can occur. Colored version: form-pressed ash veneer shell and base. All with water-based lacquer. Stainless steel or powder coated steel footrest. Plastic glides.

Certificates & Warranty

Strength & Stability: EN 16139 - L2, EN 1022. **Eco Labels & Safety:** Declare Red list approved, GreenTag Level C-, VOC CDPH 01350 and BIFMA X7.1. **Warranty:** 5 years

Options

Felt glides.

Color Options & Codes

Shell & Base: Oak, White* (RAL 9016), Black (RAL 9017), Grey (RAL 7040), Dark Green (RAL 6012), Tan Rose (NCS S 2030-Y80R).

*Not available as base color

Ready-To-Ship Options

Shell / Base

Oak	
White / Oak	
Black	
Grey	
Dark Green	
Tan Rose	

Dimensions

Visu Bar Stool

Height: 89 cm / 35"
Width: 42,4 cm / 16.7"
Depth: 41,8 cm / 16.5"
Seat height: 75 cm / 29.5"
Seat depth: 39,5 cm / 15.6"
Seat width: 38 cm / 15"

Visu Counter Stool

Height: 79 cm / 31.1"
Width: 41,3 cm / 16.3"
Depth: 40,1 cm / 15.8"
Seat height: 65 cm / 25.5"
Seat depth: 39,5 cm / 15.6"
Seat width: 38 cm / 15"



Configurable

Wood Base
 — Full Upholstery

Materials

Oak version: Form pressed oak veneer shell and base. Slight color variation can occur. Colored version: form-pressed ash veneer shell and base. All with water-based lacquer. Fully upholstered shell with textile or leather. Stainless steel or powder coated steel footrest. Plastic glides.

Certificates & Warranty

Strength & Stability: EN 16139 - L2, EN 1022.

Eco Labels & Safety: Declare Red list approved, GreenTag Level C**, VOC CDPH 01350* and BIFMA X7.1*, Crib 5 upon request.

Warranty: 5 years

Options

Felt glides.

Color Options & Codes

Upholstery: Textile, leather. See the wide selection in our digital Product Configurator and visit our Price List for a full overview.

Base: Oak, Black (RAL 9017), Grey (RAL 7040), Dark Green (RAL 6012), Tan Rose (NCS S 2030-Y80R).

Dimensions

Visu Bar Stool

Height: 89 cm / 35"
Width: 42,4 cm / 16.7"
Depth: 41,8 cm / 16.5"
Seat height: 75 cm / 29.5"
Seat depth: 39,5 cm / 15.6"
Seat width: 38 cm / 15"

Visu Counter Stool

Height: 79 cm / 31.1"
Width: 41,3 cm / 16.3"
Depth: 40,1 cm / 15.8"
Seat height: 65 cm / 25.5"
Seat depth: 39,5 cm / 15.6"
Seat width: 38 cm / 15"

visu lounge chair

by Mika Tolvanen

Visu Lounge Chair has a timeless yet modern profile, designed with comfort at its heart in form-pressed veneer for a deep, embracing seat.



Wood Base
— Shell

Materials

Oak version: Shell and base in oak veneer. Slight color variation can occur. Colored version: shell and base in ash veneer. All in water-based lacquer. Plastic glides.

Certificates & Warranty

Strength & Stability: EN 16139 - L2, EN 1022.
Eco Labels & Safety: Declare Red list approved, GeenTag Level C, VOC CDPH 01350 and BIFMA X7.1.
Warranty: 5 years

Options





Felt glides.

Color Options & Codes

Shell & Base: Oak, Black (RAL 9017), Grey (RAL 7040), Dusty Green (NCS S 4010-G50Y).

Ready-To-Ship Options

Shell / Base

Oak	
Black	
Grey	
Dusty Green	

Dimensions

Height:	70 cm / 27.6"
Width:	60 cm / 23.5"
Depth:	58,5 cm / 23"
Seat height:	39,5 cm / 15.6"
Seat depth:	42 cm / 16.5"
Seat width:	60 cm / 23.5"



Wood Base
— Full Upholstery

Materials

Form-pressed ash veneer shell with foam and fully upholstered with textile or leather. Form-pressed wood base in veneer with water-based lacquer. For Oak versions slight color variation can occur. Plastic glides.

Certificates & Warranty

Strength & Stability: EN 16139 - L2, EN 1022. **Eco Labels & Safety:** Declare Red list approved, GreenTag Level C**, VOC CDPH 01350* and BIFMA X7.1*, Crib 5 upon request.
Warranty: 5 years

Options

Felt glides.

Color Options & Codes

Upholstery: Textile, leather. See the wide selection in our digital Product Configurator and visit our Price List for a full overview.

Base: Oak, Black (RAL 9017), Grey (RAL 7040), Dusty Green (NCS S 4010-G50Y).

Dimensions

Height:	70 cm / 27.6"
Width:	60 cm / 23.5"
Depth:	58,5 cm / 23"
Seat height:	39,5 cm / 15.6"
Seat depth:	42 cm / 16.5"
Seat width:	60 cm / 23.5"



W 60 cm / 23.5"



D 58,5 cm / 23"

H 70 cm / 27.6"
SH 39,5 cm / 15.6"

*Valid for a large selection of Kvadrat upholstery. Refine and Easy leather.
**Valid for a large selection of Kvadrat upholstery.

The Outline Sofa Family adds new perspectives to the classic Scandinavian design sofas of the 1960s, marrying the ideals of simplicity and function into one. With the design taking its name from its strong sofa outline, the Outline Family is clean and elegant on the outside, with a deep seat and soft cushioning inside. The Outline Highback Sofas are designed to create intimate sceneries within larger rooms, providing sheltered, private space for focused work, small meetings, or withdrawal. Adding to its functionality and flexibility, the Outline Highback Sofa fits into any modern office, hospitality, or educational environment.

outline

sofa

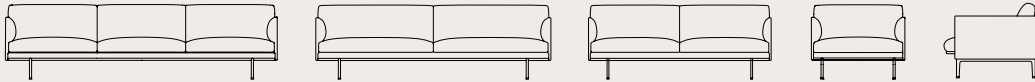


series

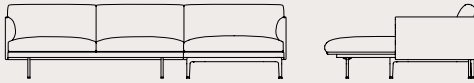
by Anderssen & Voll



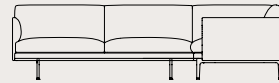
Sofas in various lengths. A chair. A chaise longue. A corner sofa. A daybed. A pouf. A slimmed-down studio sofa series for apartments, hotel rooms, and workplaces. A Highback Sofa in three different sizes. A cabin with or without a table for a personal meeting space. The Outline Family comes in many versions, all characterized by simple lines and refined expression alongside a deep, soft seat.



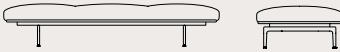
Sofa & Chair
3 1/2-seater, 3-seater, 2-seater & Chair



Chaise Longue



Corner Sofa



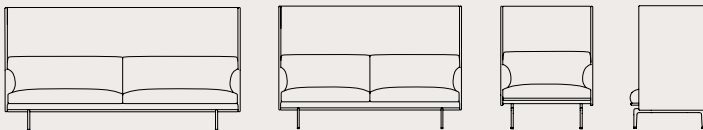
Daybed



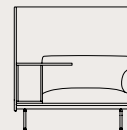
Pouf



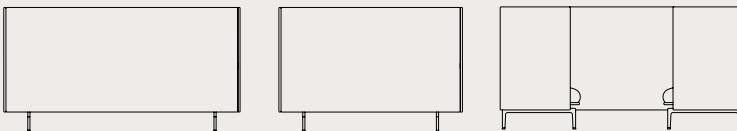
Studio Sofa
3 1/2-seater, 3-seater, 2-seater & Chair



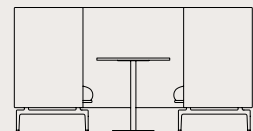
Highback Sofa
3-seater, 2-seater, 1-seater



Highback Work
1-seater



Highback Cabin
3-seater, 2-seater



Highback Cabin w. Table
2-seater

outline sofa

by Anderssen & Voll

The Outline Series combines a soft, deep seat with clean and refined lines, a rare example of an elegant lounge sofa. The design has a timeless character, making it ideal for versatile settings such as lounge areas within office spaces, public spaces, and hospitality settings.



Configurable

Outline Sofa
— 3 1/2-Seater

Materials

Wood and steel construction. Cold foam granulate with upholstery in textile, imitation leather, or leather. Powder coated or polished aluminum legs.

Certificates & Warranty

Strength & Stability: EN 16139 - L2, EN 1022, BIFMA X5.4. **Eco Labels & Safety:** Declare Red list approved*, VOC CDPH 01350* and BIFMA X7.1*, Crib 5 upon request.

Warranty: 10 years

Options

Power Outlet.

Color Options & Codes

Upholstery: Textile, imitation leather, or leather. See the wide selection in our digital Product Configurator and visit our Price List for a full overview.

Legs: Black (RAL 9005), Polished Aluminum.

Dimensions

Width:	255 cm / 100.4"
Height:	71 cm / 28"
Depth:	84 cm / 33"
Seat height:	40 cm / 15.75"
Seat depth:	62 cm / 24.5"
Seat width:	235 cm / 95.5"
Armrest Height:	60 cm / 23.6"



Configurable

Outline Sofa
— 3-Seater

Materials

Wood and steel construction. Cold foam granulate with upholstery in textile, imitation leather, or leather. Powder coated or polished aluminum legs.

Certificates & Warranty

Strength & Stability: EN 16139 - L2, EN 1022, BIFMA X5.4. **Eco Labels & Safety:** Declare Red list approved*, VOC CDPH 01350* and BIFMA X7.1*, Crib 5 upon request.

Warranty: 10 years

Options

Power Outlet.

Color Options & Codes

Upholstery: Textile, imitation leather, or leather. See the wide selection in our digital Product Configurator and visit our Price List for a full overview.

Legs: Black (RAL 9005), Polished Aluminum.

Ready-To-Ship Options

Upholstery/Legs

Remix 163 / Black	
Clay 12 / Black	
Ecriture 240 / Polished Aluminum	
Refine Leather Cognac / Black	

Dimensions

Width:	220 cm / 86.5"
Height:	71 cm / 28"
Depth:	84 cm / 33"
Seat height:	40 cm / 15.75"
Seat depth:	62 cm / 24.5"
Seat width:	200 cm / 78.75"
Armrest Height:	60 cm / 23.6"



Configurable

Outline Sofa
— 2-Seater

Materials

Wood and steel construction. Cold foam granulate with upholstery in textile, imitation leather, or leather. Powder coated or polished aluminum legs.

Certificates & Warranty

Strength & Stability: EN 16139 - L2, EN 1022, BIFMA X5.4. **Eco Labels & Safety:** Declare Red list approved*, VOC CDPH 01350* and BIFMA X7.1*, Crib 5 upon request.

Warranty: 10 years

Options

Power Outlet.

Color Options & Codes

Upholstery: Textile, imitation leather, or leather. See the wide selection in our digital Product Configurator and visit our Price List for a full overview.

Legs: Black (RAL 9005), Polished Aluminum.

Ready-To-Ship Options

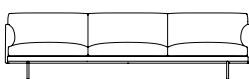
Upholstery/Legs

Remix 163 / Black	
Clay 12 / Black	
Ecriture 240 / Polished Aluminum	
Refine Leather Cognac / Black	

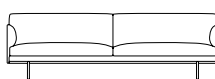
Dimensions

Width:	170 cm / 67"
Height:	71 cm / 28"
Depth:	84 cm / 33"
Seat height:	40 cm / 15.75"
Seat depth:	62 cm / 24.5"
Seat width:	150 cm / 59"
Armrest Height:	60 cm / 23.6"

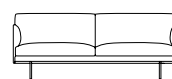
*Valid for a large selection of Kvadrat upholstery, Refine and Easy leather. VOC BIFMA X7.1 is not valid for leather.



W 225 cm / 100.4"



W 220 cm / 86.75"



W 170 cm / 67"



D 84 cm / 33"

H 71 cm / 28"
SH 40 cm / 15.75"



Configurable

Outline Chair

Materials

Wood and steel construction. Cold foam granulate with upholstery in textile, imitation leather, or leather. Powder coated or polished aluminum legs.

Certificates & Warranty

Strength & Stability: EN 16139 - L2, EN 1022, BIFMA X5.4. **Eco Labels & Safety:** Declare Red list approved*, VOC CDPH 01350* and BIFMA X7.1*, Crib 5 upon request.

Warranty: 10 years

Options

Power Outlet.

Color Options & Codes

Upholstery: Textile, imitation leather, or leather. See the wide selection in our digital Product Configurator and visit our Price List for a full overview.

Legs: Black (RAL 9005), Polished Aluminum.

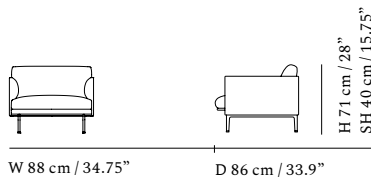
Ready-To-Ship Options

Upholstery/Legs

Remix 163 / Black	
Clay 12 / Black	
Ecriture 240 / Polished Aluminum	
Refine Leather Cognac / Black	

Dimensions

Width:	88 cm / 34.75"
Height:	71 cm / 28"
Depth:	84 cm / 33.9"
Seat height:	40 cm / 15.75"
Seat depth:	62 cm / 24.5"
Seat width:	70 cm / 27.5"
Armrest Height:	60 cm / 23.6"



Configurable

Outline Sofa

— Corner

Materials

Wood and steel construction. Cold foam granulate with upholstery in textile, imitation leather, or leather. Powder coated or polished aluminum legs.

Certificates & Warranty

Strength & Stability: EN 16139 - L2, EN 1022, BIFMA X5.4. **Eco Labels & Safety:** Declare Red list approved*, VOC CDPH 01350* and BIFMA X7.1*, Crib 5 upon request.

Warranty: 10 years

Options

Power Outlet.

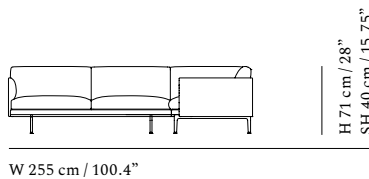
Color Options & Codes

Upholstery: Textile, imitation leather, or leather. See the wide selection in our digital Product Configurator and visit our Price List for a full overview.

Legs: Black (RAL 9005), Polished Aluminum.

Dimensions

Width:	255 cm / 100.4"
Height:	71 cm / 28"
Depth:	84 cm / 33"
Seat height:	40 cm / 15.75"
Seat depth:	62 cm / 24.5"
Seat width:	220 cm / 86.5"
Armrest Height:	60 cm / 23.6"



Configurable

Outline Sofa

— Chaise Longue

Materials

Wood and steel construction. Cold foam granulate with upholstery in textile, imitation leather, or leather. Powder coated or polished aluminum legs.

Certificates & Warranty

Strength & Stability: EN 16139 - L2, EN 1022, BIFMA X5.4. **Eco Labels & Safety:** Declare Red list approved*, VOC CDPH 01350* and BIFMA X7.1*, Crib 5 upon request.

Warranty: 10 years

Options

Power Outlet.

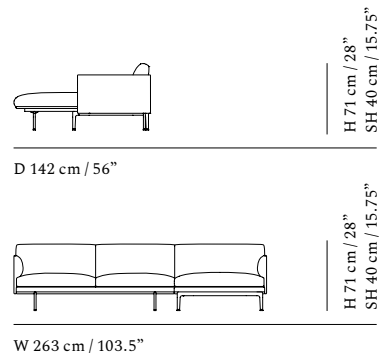
Color Options & Codes

Upholstery: Textile, imitation leather, or leather. See the wide selection in our digital Product Configurator and visit our Price List for a full overview.

Legs: Black (RAL 9005), Polished Aluminum.

Dimensions

Width:	263 cm / 103.5"
Height:	71 cm / 28"
Depth:	142 cm / 56"
Seat height:	40 cm / 15.75"
Seat depth:	62-122 cm / 24.5-48"
Armrest Height:	60 cm / 23.6"



*Valid for a large selection of Kvadrat upholstery, Refine and Easy leather. VOC BIFMA X7.1 is not valid for leather.

outline studio sofa

by Anderssen & Voll

The Outline Studio Series, designed in slimmed-down proportions for smaller spaces such as apartments, hotel rooms, workplaces, and more, has an expression that is at once elegant yet timeless, elevated by its lines referencing architectural shapes alongside its curved armrests, giving the design a distinct appearance across various sizes.

150

seating



Configurable

Outline Studio Sofa
— 220 cm / 86.5"

Materials

Wood and steel construction. Cold foam granulate with upholstery in textile, imitation leather, or leather. Powder coated or polished aluminum legs.

Certificates & Warranty

Strength & Stability: EN 16139 - L2, EN 1022, BIFMA X5.4. **Eco Labels & Safety:** Declare Red list approved*, VOC CDPH 01350* and BIFMA X7.1*, Crib 5 upon request.

Warranty: 10 years

Options

Power Outlet. Available with seat height 45 cm / 17.7".

Color Options & Codes

Upholstery: Textile, imitation leather, or leather. See the wide selection in our digital Product Configurator and visit our Price List for a full overview.
Legs: Black (RAL 9005), Polished Aluminum.

Dimensions

Width:	220 cm / 86.5"
Height:	71 cm / 28"
Depth:	76 cm / 30"
Seat height:	40 cm / 15.75"
Seat depth:	54 cm / 21.25"
Seat width:	200 cm / 78.7"
Armrest Height:	60 cm / 23.6"



Configurable

Outline Studio Sofa
— 170 cm / 67"

Materials

Wood and steel construction. Cold foam granulate with upholstery in textile, imitation leather, or leather. Powder coated or polished aluminum legs.

Certificates & Warranty

Strength & Stability: EN 16139 - L2, EN 1022, BIFMA X5.4. **Eco Labels & Safety:** Declare Red list approved*, VOC CDPH 01350* and BIFMA X7.1*, Crib 5 upon request.

Warranty: 10 years

Options

Power Outlet. Available with seat height 45 cm / 17.7".

Color Options & Codes

Upholstery: Textile, imitation leather, or leather. See the wide selection in our digital Product Configurator and visit our Price List for a full overview.
Legs: Black (RAL 9005), Polished Aluminum.

Dimensions

Width:	170 cm / 67"
Height:	71 cm / 28"
Depth:	76 cm / 30"
Seat height:	40 cm / 15.75"
Seat depth:	54 cm / 21.25"
Seat width:	150 cm / 59.1"
Armrest Height:	60 cm / 23.6"



Configurable

Outline Studio Sofa
— 140 cm / 55"

Materials

Wood and steel construction. Cold foam granulate with upholstery in textile, imitation leather, or leather. Powder coated or polished aluminum legs.

Certificates & Warranty

Strength & Stability: EN 16139 - L2, EN 1022, BIFMA X5.4. **Eco Labels & Safety:** Declare Red list approved*, VOC CDPH 01350* and BIFMA X7.1*, Crib 5 upon request.

Warranty: 10 years

Options

Power Outlet. Available with seat height 45 cm / 17.7".

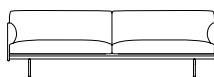
Color Options & Codes

Upholstery: Textile, imitation leather, or leather. See the wide selection in our digital Product Configurator and visit our Price List for a full overview.
Legs: Black (RAL 9005), Polished Aluminum.

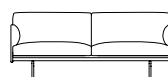
Dimensions

Width:	140 cm / 55"
Height:	71 cm / 28"
Depth:	76 cm / 30"
Seat height:	40 cm / 15.75"
Seat depth:	54 cm / 21.25"
Seat width:	120 cm / 47.25"
Armrest Height:	60 cm / 23.6"

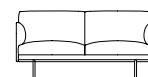
*Valid for a large selection of Kvadrat upholstery, Refine and Easy leather. VOC BIFMA X7.1 is not valid for leather.



W 220 cm / 86.5"



W 170 cm / 67"



W 140 cm / 55"



D 76 cm / 30"

H 71 cm / 28"
SH 40 cm / 15.75"

outline pouf & daybed

by Anderssen & Voll

The Outline Pouf and Daybed echo the elegant, simple lines of the Outline Series, making them a perfect addition to any lounge setting. Use the pouf as a footstool as well as an extra seat, and add the Outline Daybed Cushion for additional comfort and neckrest to the Daybed.



Configurable

Outline Studio Chair

Materials

Wood and steel construction. Cold foam granulate with upholstery in textile, imitation leather, or leather. Powder coated or polished aluminum legs.

Certificates & Warranty

Strength & Stability: EN 16139 - L2, EN 1022, BIFMA X5.4. **Eco Labels & Safety:** Declare Red list approved*, VOC CDPH 01350* and BIFMA X7.1*, Crib 5 upon request.

Warranty: 10 years

Options

Power Outlet. Available with seat height 45 cm / 17.7".

Color Options & Codes

Upholstery: Textile, imitation leather, or leather. See the wide selection in our digital Product Configurator and visit our Price List for a full overview. **Legs:** Black (RAL 9005), Polished Aluminum.

Dimensions

Width:	78 cm / 30.75"
Height:	71 cm / 28"
Depth:	76 cm / 30"
Seat height:	40 cm / 15.75"
Seat depth:	54 cm / 21.25"
Seat width:	60 cm / 23.5"
Armrest Height:	60 cm / 23.6"



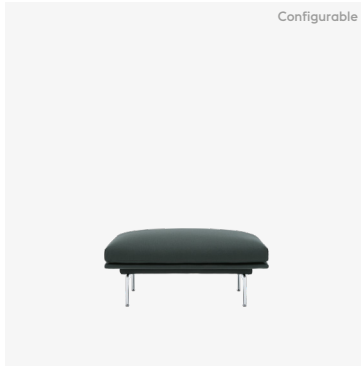
W 78 cm / 30.75"



D 76 cm / 30"

H 71 cm / 28"
SH 40 cm / 15.75"

*Valid for a large selection of Kvadrat upholstery. Refine and Easy leather. VOC BIFMA X7.1 is not valid for leather.



Configurable

Outline Pouf

Materials

Wood and steel construction. Cold foam granulate with upholstery in textile, imitation leather, or leather. Powder coated or polished aluminum legs.

Certificates & Warranty

Strength & Stability: EN 16139 - L2, EN 1022, BIFMA X5.4. **Eco Labels & Safety:** Declare Red list approved*, VOC CDPH 01350* and BIFMA X7.1*, Crib 5 upon request.

Warranty: 10 years

Options

Power Outlet.

Color Options & Codes

Upholstery: Textile, imitation leather, or leather. See the wide selection in our digital Product Configurator and visit our Price List for a full overview. **Legs:** Black (RAL 9005), Polished Aluminum.

Dimensions

Width:	111 cm / 43.75"
Height:	40 cm / 15.75"
Depth:	78 cm / 30.75"



W 111 cm / 43.75"



D 78 cm / 30.75"

H 40 cm / 15.75"



Configurable

Outline Daybed

Materials

Wood and steel construction. Cold foam granulate with upholstery in textile, imitation leather, or leather. Powder coated or polished aluminum legs.

Certificates & Warranty

Strength & Stability: EN 16139 - L2, EN 1022. **Eco Labels & Safety:** Declare Red list approved*, VOC CDPH 01350* and BIFMA X7.1*, Crib 5 upon request.

Warranty: 10 years

Options

Power Outlet. Daybed Cushion.

Color Options & Codes

Upholstery: Textile, imitation leather, or leather. See the wide selection in our digital Product Configurator and visit our Price List for a full overview. **Legs:** Black (RAL 9005), Polished Aluminum.

Ready-To-Ship Options

Upholstery/Legs

Refine Leather Cognac / Black



Dimensions

Width:	200 cm / 78.8"
Height:	40 cm / 15.75"
Depth:	82 cm / 32.3"



W 200 cm / 78.8"



D 82 cm / 32.3"

H 40 cm / 15.75"

outline highback sofa

by Anderssen & Voll

The Outline Highback sofas combine the soft, deep seat and clean, refined lines of Outline with a highback element, allowing the design to create an acoustic shelter and private sphere for work and conversations.



Configurable

Outline Highback Sofa
— 3-Seater

Materials

Wood and steel construction. Cold foam granulate with upholstery in textile, imitation leather, or leather. Powder coated or polished aluminum legs.

Certificates & Warranty

Strength & Stability: EN 16139 - L2, EN 1022, BIFMA X5.4. **Eco Labels & Safety:** Declare Red list approved*, VOC CDPH 01350* and BIFMA X7.1*, Crib 5 upon request.

Warranty: 10 years

Options

Power Outlet. Available with seat height 45 cm / 17.7".

Color Options & Codes

Upholstery: Textile, imitation leather, or leather. See the wide selection in our digital Product Configurator and visit our Price List for a full overview.

Legs: Black (RAL 9005), Polished Aluminum.

Dimensions

Highback 3-Seater - 100 cm

Width:	220 cm / 86.75"
Total Height:	115 cm / 45.3"
Highback Height:	100 cm / 39.4"
Depth:	76 cm / 29.9"
Seat Height:	40 cm / 15.7"
Seat Depth:	54 cm / 21.3"
Seat Width:	200 cm / 78.7"
Armrest Height:	60 cm / 23.6"

Highback 3-Seater - 120 cm

Width:	220 cm / 86.75"
Total Height:	140 cm / 55.12"
Highback Height:	120 cm / 47.3"
Depth:	76 cm / 29.9"
Seat height:	40 cm / 15.7"
Seat depth:	54 cm / 21.3"
Seat Width:	200 cm / 78.7"
Armrest Height:	60 cm / 23.6"



Configurable

Outline Highback Sofa
— 2-Seater

Materials

Wood and steel construction. Cold foam granulate with upholstery in textile, imitation leather, or leather. Powder coated or polished aluminum legs.

Certificates & Warranty

Strength & Stability: EN 16139 - L2, EN 1022, BIFMA X5.4. **Eco Labels & Safety:** Declare Red list approved*, VOC CDPH 01350* and BIFMA X7.1*, Crib 5 upon request.

Warranty: 10 years

Options

Power Outlet. Available with seat height 45 cm / 17.7".

Color Options & Codes

Upholstery: Textile, imitation leather, or leather. See the wide selection in our digital Product Configurator and visit our Price List for a full overview.

Legs: Black (RAL 9005), Polished Aluminum.

Dimensions

Highback 2-Seater - 100 cm

Width:	170 cm / 67"
Total Height:	115 cm / 45.3"
Highback Height:	100 cm / 39.4"
Depth:	76 cm / 29.9"
Seat Height:	40 cm / 15.7"
Seat Depth:	54 cm / 21.3"
Seat Width:	150 cm / 59.1"
Armrest Height:	60 cm / 23.6"

Highback 2-Seater - 120 cm

Width:	170 cm / 67"
Total Height:	140 cm / 55.12"
Highback Height:	120 cm / 47.3"
Depth:	76 cm / 29.9"
Seat Height:	40 cm / 15.7"
Seat Depth:	54 cm / 21.3"
Seat Width:	150 cm / 59.1"
Armrest Height:	60 cm / 23.6"



Configurable

Outline Highback Sofa
— 1-Seater

Materials

Wood and steel construction. Cold foam granulate with upholstery in textile, imitation leather, or leather. Powder coated or polished aluminum legs.

Certificates & Warranty

Strength & Stability: EN 16139 - L2, EN 1022, BIFMA X5.4. **Eco Labels & Safety:** Declare Red list approved*, VOC CDPH 01350* and BIFMA X7.1*, Crib 5 upon request.

Warranty: 10 years

Options

Power Outlet. Available with seat height 45 cm / 17.7".

Color Options & Codes

Upholstery: Textile, imitation leather, or leather. See the wide selection in our digital Product Configurator and visit our Price List for a full overview.

Legs: Black (RAL 9005), Polished Aluminum.

Dimensions

Highback 1-Seater - 100 cm

Width:	88 cm / 34.7"
Total Height:	115 cm / 45.3"
Highback Height:	100 cm / 39.4"
Depth:	76 cm / 29.9"
Seat height:	40 cm / 15.7"
Seat depth:	54cm / 21.3"
Seat width:	68cm / 26.8"
Armrest height:	60cm / 23.6"

Highback 1-Seater - 120 cm

Width:	88 cm / 34.7"
Total Height:	140 cm / 55.12"
Highback Height:	120 cm / 47.3"
Depth:	76 cm / 29.9"
Seat height:	40 cm / 15.7"
Seat depth:	54cm / 21.3"
Seat width:	68cm / 26.8"
Armrest height:	60cm / 23.6"

*Valid for a large selection of Konradt upholstery, Refine and Easy leather. VOC BIFMA X7.1 is not valid for leather.



Outline Highback Cabin
— 3-Seater

Materials

Wood and steel construction. Cold foam granulate with upholstery in textile, imitation leather, or leather. Powder coated or polished aluminum legs.

Certificates & Warranty

Strength & Stability: EN 16139 - L2, EN 1022, BIFMA X5.4. **Eco Labels & Safety:** Declare Red list approved*, VOC CDPH 01350* and BIFMA X7.1*, Crib 5 upon request.

Warranty: 10 years

Options

Power Outlet. Available with seat height 45 cm / 17.7".

Color Options & Codes

Upholstery: Textile, imitation leather, or leather. See the wide selection in our digital Product Configurator and visit our Price List for a full overview.
Legs: Black (RAL 9005), Polished Aluminum.

Dimensions

Highback Cabin 3-Seater - 100 cm

Width:	231 cm / 90.94"
Total Height:	115 cm / 45.3"
Highback Height:	100 cm / 39.4"
Depth:	220 cm / 86.6"
Seat Height:	40 cm / 15.7"
Seat Depth:	54 cm / 21.3"
Seat Width:	200 cm / 78.7"
Armrest Height:	60 cm / 23.6"

Highback Cabin 3-Seater - 120 cm

Width:	231 cm / 90.94"
Total Height:	140 cm / 55.12"
Highback Height:	120 cm / 47.3"
Depth:	220 cm / 86.6"
Seat Height:	40 cm / 15.7"
Seat Depth:	54 cm / 21.3"
Seat Width:	200 cm / 78.7"
Armrest Height:	60 cm / 23.6"



Outline Highback Cabin
— 2-Seater

Materials

Wood and steel construction. Cold foam granulate with upholstery in textile, imitation leather, or leather. Powder coated or polished aluminum legs.

Certificates & Warranty

Strength & Stability: EN 16139 - L2, EN 1022, BIFMA X5.4. **Eco Labels & Safety:** Declare Red list approved*, VOC CDPH 01350* and BIFMA X7.1*, Crib 5 upon request.

Warranty: 10 years

Options

Power Outlet. Available with seat height 45 cm / 17.7".

Color Options & Codes

Upholstery: Textile, imitation leather, or leather. See the wide selection in our digital Product Configurator and visit our Price List for a full overview.
Legs: Black (RAL 9005), Polished Aluminum.

Dimensions

Highback Cabin 2-Seater - 100 cm

Width:	231 cm / 90.94"
Total Height:	115 cm / 45.3"
Highback Height:	100 cm / 39.4"
Depth:	170 cm / 66.9"
Seat Height:	40 cm / 15.7"
Seat Depth:	54 cm / 21.3"
Seat Width:	150 cm / 59.1"
Armrest Height:	60 cm / 23.6"

Highback Cabin 2-Seater - 120 cm

Width:	231 cm / 90.94"
Total Height:	140 cm / 55.12"
Highback Height:	120 cm / 47.3"
Depth:	170 cm / 66.9"
Seat Height:	40 cm / 15.7"
Seat Depth:	54 cm / 21.3"
Seat Width:	150 cm / 59.1"
Armrest Height:	60 cm / 23.6"



Outline Highback Cabin w. Table
— 2-Seater

Materials

Wood and steel construction. Cold foam granulate with upholstery in textile, imitation leather, or leather. Powder coated or polished aluminum legs. The table unit is made from robust MDF board with matte laminate (black ABS edges).

Certificates & Warranty

Strength & Stability: EN 16139 - L2, BIFMA X5.4, BIFMA X5.5*. **Eco Labels & Safety:** VOC CDPH 01350* and BIFMA X7.1* (VOC tests only valid for the table), Crib 5 upon request.

Warranty: 10 years

Options

Power Outlet. Available with seat height 45 cm / 17.7".

Color Options & Codes

Upholstery: Textile, imitation leather, or leather. See the wide selection in our digital Product Configurator and visit our Price List for a full overview.
Legs: Black (RAL 9005), Polished Aluminum.
Table: Black (nearest match RAL 9004).

Dimensions

Highback Cabin w. table 2-Seater - 100 cm

Width:	231 cm / 90.94"
Total Height:	115 cm / 45.3"
Highback Height:	100 cm / 39.4"
Depth:	170 cm / 66.9"
Seat Height:	40 cm / 15.7"
Seat Depth:	54 cm / 21.3"
Seat Width:	150 cm / 59.1"
Armrest Height:	60 cm / 23.6"
Table Width:	70 cm / 27.56"
Table Height:	71 cm / 27.95"
Table Depth:	135 cm / 53.15"

Highback Cabin w. table 2-Seater - 120 cm

Width:	231 cm / 90.94"
Total Height:	140 cm / 55.12"
Highback Height:	120 cm / 47.3"
Depth:	170 cm / 66.9"
Seat Height:	40 cm / 15.7"
Seat Depth:	54 cm / 21.3"
Seat Width:	150 cm / 59.1"
Armrest Height:	60 cm / 23.6"
Table Width:	70 cm / 27.56"
Table Height:	71 cm / 27.95"
Table Depth:	135 cm / 53.15"

outline highback work

by Anderssen & Voll

The Highback Work has an integrated storage room alongside a cable outlet that can be added for easy power access. The Outline Highbacks are ideal for any open-plan space, hospitality setting, workplace, or public area.



Outline Highback Work — 1-Seater

Materials

Plywood and steel construction with cold foam and upholstered with textile, imitation leather, or leather. The table unit is made from robust MDF board with matte laminate (black ABS edges). Powder coated or polished aluminum legs.

Certificates & Warranty

Table unit is not tested.

Strength & Stability: EN 16139 - L2, BIFMA X5.4.

Eco Labels & Safety: VOC CDPH 01350* and BIFMA X7.1*, Crib 5 upon request.

Warranty: 10 years

Options

Power Outlet. Available with seat height 45 cm / 17.7". Table unit available for either right or left side.

Color Options & Codes

Upholstery: Textile, imitation leather, or leather. See the wide selection in our digital Product Configurator and visit our Price List for a full overview.

Legs: Black (RAL 9005), Polished Aluminum.

Table unit: Black integrated desk and storage (nearest match RAL 9004).

Dimensions

Highback Work 1-Seater - 100 cm

Width:	111 cm / 43.7"
Total Height:	115 cm / 45.3"
Highback Height:	100 cm / 39.4"
Depth:	78 cm / 30.7"
Seat height:	40 cm / 15.7"
Seat depth:	54 cm / 21.3"
Seat Width:	75 cm / 29.5"
Armrest Height:	60 cm / 23.6"

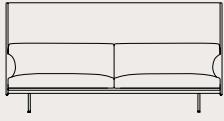
Highback Work 1-Seater - 120 cm

Width:	111 cm / 43.7"
Total Height:	140 cm / 55.12"
Highback Height:	120 cm / 47.3"
Depth:	78 cm / 30.7"
Seat height:	40 cm / 15.7"
Seat depth:	54 cm / 21.3"
Seat Width:	75 cm / 29.5"
Armrest Height:	60 cm / 23.6"

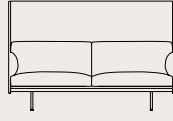


*Valid for a large selection of Knorr upholstery, Refine and Easy leather. VOC BIFMA X7.1 is not valid for leather.

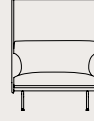
Highback – 100 cm



Highback 3-seater
W 220 cm / 86.75"



Highback 2-seater
W 170 cm / 67"



Highback 1-seater
W 88 cm / 34.7"

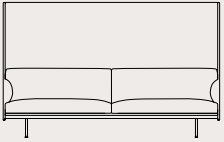


D 76 cm / 29.9"

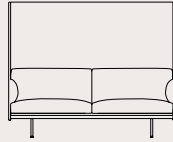
100 cm / 39.37"

H 115 cm / 45.3"
SH 40 cm / 15.7"

Highback – 120 cm



Highback 3-seater
W 220 cm / 86.75"



Highback 2-seater
W 170 cm / 67"



Highback 1-seater
W 88 cm / 34.7"

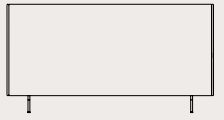


D 76 cm / 29.9"

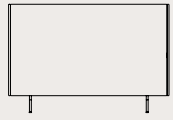
120 cm / 47.24"

H 140 cm / 55.12"
SH 40 cm / 15.7"

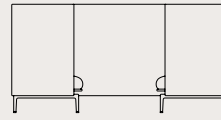
Highback Cabin – 100 cm



Highback 3-seater
D 220 cm / 86.75"



Highback 2-seater
D 170 cm / 67"



W 231 cm / 90.94"

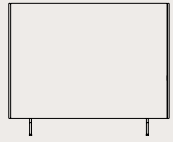
100 cm / 39.37"

H 115 cm / 45.3"
SH 40 cm / 15.7"

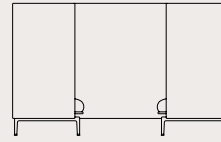
Highback Cabin – 120 cm



Highback 3-seater
D 220 cm / 86.75"



Highback 2-seater
D 170 cm / 67"

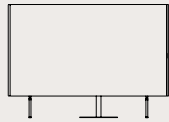


W 231 cm / 90.94"

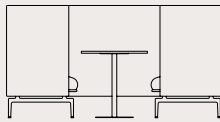
120 cm / 47.24"

H 140 cm / 55.12"
SH 40 cm / 15.7"

Highback Cabin w. Table – 100 cm



Highback 2-seater
D 170 cm / 67"

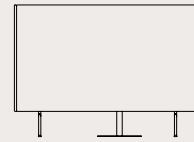


W 231 cm / 90.94"

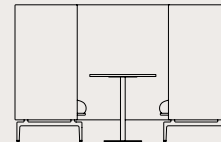
100 cm / 39.37"

H 115 cm / 45.3"
SH 40 cm / 15.7"

Highback Cabin w. Table – 120 cm



Highback 2-seater
D 170 cm / 67"

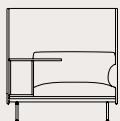


W 231 cm / 90.94"

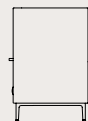
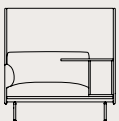
120 cm / 47.24"

H 140 cm / 55.12"
SH 40 cm / 15.7"

Highback Work – 100 cm



Highback Work
W 111 cm / 43.7"

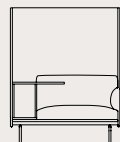


D 78 cm / 30.7"

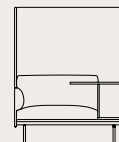
100 cm / 39.37"

H 115 cm / 45.3"
SH 40 cm / 15.7"

Highback Work – 120 cm



Highback Work
W 111 cm / 43.7"



D 78 cm / 30.7"

120 cm / 47.24"

H 140 cm / 55.12"
SH 40 cm / 15.7"

connect modular sofa

by Anderssen & Voll

Connect Modular Sofa brings a modern perspective to the typology, allowing for its user to customize the sofa for their exact spatial and aesthetic needs with 14 different modules. Designed with long, elegant lines, the Connect Modular Sofa's details of its small feet underneath for a hovering, light sentiment and pointy corners allows for the design to bring character to any space, all while complementing and enhancing its surroundings. Use the Connect Modular Sofa for a modern comfort in any workplace, lounge area or hospitality setting.

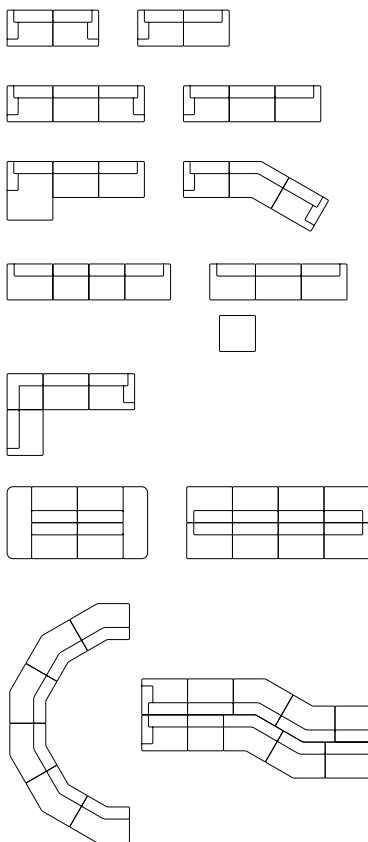
156



Configurable

Connect Modular Sofa

Inspiration



*Valid for a large selection of Kvadrat upholstery.

Materials

Wooden frame with zig-zag springs covered with felt, foam and wadding. Textile upholstery. Modules are connected with metals brackets.

Certificates & Warranty

Strength & Stability: EN 1022, EN 16139 - L2, BIFMA X5.4 Eco Labels & Safety: Declare Red list approved*, VOC CDPH 01350* and BIFMA X7.1*, Crib 5 upon request.

Warranty: 10 years

Color Options

Upholstery: Textile. See the wide selection in our digital Product Configurator and visit our Price List for a full overview.

Dimensions

Across all modules

Height: 70 cm / 27.5"

Seat height: 42 cm / 16.5"

Armrest height: 56 cm / 22"

Please note that the modules H & I can only be used as a freestanding ottoman and not part of the sofa configuration.



W 118,5 cm / 46.65"
SW 88 cm / 34.65"



W 118,5 cm / 46.65"
SW 88 cm / 34.65"

D 98 cm / 38.58"
SD 64 cm / 25.20"
SH 42 cm / 16.54"



W 118,5 cm / 46.65"

D 98 cm / 38.58"
SD 64 cm / 25.20"
SH 42 cm / 16.54"



W 94,5 cm / 37.20"

D 98 cm / 38.58"
SD 64 cm / 25.20"
SH 42 cm / 16.54"



W 98 cm / 38.58"



W 118,5 cm / 46.65"

D 98 cm / 38.58"
SD 64 cm / 25.20"
SH 42 cm / 16.54"



W 118,5 cm / 46.65"

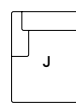


W 118,5 cm / 46.65"

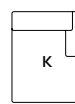


98 cm / 38.58"

D 98 cm / 38.58"
SH 42 cm / 16.54"



W 118,5 cm / 46.65"
SW 88 cm / 34.65"



W 118,5 cm / 46.65"
SW 88 cm / 34.65"

D 155 cm / 61.02"
SD 122 cm / 48.03"
SH 42 cm / 16.54"



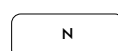
W 158 cm / 62.20"
SW 144 cm / 56.69"

D 113 cm / 44.49"
SD 64 cm / 25.20"
SH 42 cm / 16.54"



W 158 cm / 62.20"
SW 125 cm / 49.21"

D 113 cm / 44.49"
SD 64 cm / 25.20"
SH 42 cm / 16.54"



W 196 cm / 77.17"
SW 196 cm / 77.17"

D 68 cm / 26.77"
SD 68 cm / 26.77"
SH 42 cm / 16.54"

seating

Create your own configuration





connect soft modular sofa

by Anderssen & Voll

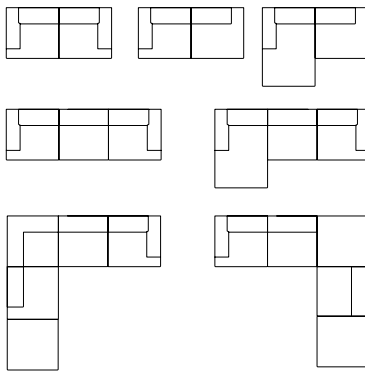
Designed with a deep, low seat, loose upholstery and an inherently soft filling, the Connect Soft Modular Sofa is at once elegant and contemporary while bringing feelings of home to modern spaces. Choose from the nine different modules and create your own configuration in the Connect Soft Modular Sofa Product Planner.



Configurable

Connect Soft Modular Sofa

Inspiration



*Valid for a large selection of Kvadrat upholstery.

Materials

Seat and back frame made in FSC™-certified wood. Back frame is covered with cold-foam filling and wadding. Seat is made with zig-zag springs, felt, cold-foam and wadding. Textiles, imitation leather, or leather upholstery with a thin lining of wadding underneath. Connecting metal brackets.

Certificates & Warranty

Strength & Stability: EN 16139 - L2, EN 1022, BIFMA X5.4. Eco Labels & Safety: VOC CDPH 01350* and BIFMA X7.1*, FSC™, Crib 5 upon request. Warranty: 10 years

Options

Cushion.

Color Options & Codes

Upholstery: Textile, imitation leather, or leather. See the wide selection in our digital Product Configurator and visit our Price List for a full overview.

Ready-To-Ship Options*

Re-wool 128

Clay 12

*Valid for module A, B, C, D, E, F & I. Module G & H are made-to-order.

Dimensions












Across all modules

Height: 69 cm / 27.17"

Seat height: 40 cm / 15.75"

Armrest height: 55,5 cm / 21.85"

Please note that the total dimensions of the pre-defined configurations are indicative and can vary due to the inherent softness of the design, depending on how close you place the modules as well as how many modules you combine.

			
W 104,5 cm / 41.14" SW 75,5 cm / 29.72"	W 104,5 cm / 41.14" SW 75,5 cm / 29.72"	W 104,5 cm / 41.14"	W 104,5 cm / 41.14"
		D 99 cm / 38.98" SD 66 cm / 25.98" SH 40 cm / 15.75"	D 99 cm / 38.98" SD 66 cm / 25.98" SH 40 cm / 15.75"
			
W 83 cm / 32.68"	W 99 cm / 38.98" SW 66 cm / 25.98"	W 104,5 cm / 41.14" SW 75,5 cm / 29.72"	W 104,5 cm / 41.14" SW 75,5 cm / 29.72"
		D 99 cm / 38.98" SD 66 cm / 25.98" SH 40 cm / 15.75"	D 154,5 cm / 60.83" SD 125 cm / 49.21" SH 40 cm / 15.75"
			
W 99 cm / 38.98"		W 64 cm / 25.2"	D 11 cm / 4.3"
		D 99 cm / 38.98" SD 66 cm / 25.98" SH 40 cm / 15.75"	H 22 cm / 8.66"



in situ modular sofa

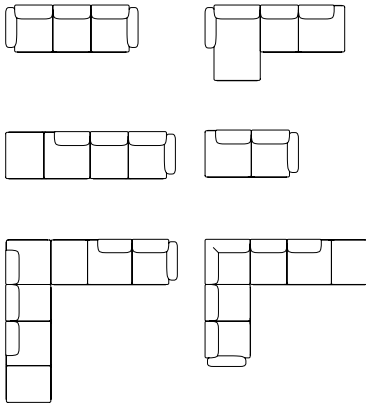
by Anderssen & Voll

A grand modular sofa that can be tailored to your exact needs with its modular elements hidden through the subtle detailing of the frame's front and back profile, paired with deep comfort and a soft seat. Choose from any of the 30 pre-designed configurations or create your own in the In Situ Product Planner, using the 9 different seating modules and two loose cushions.



In Situ Modular Sofa

Inspiration



Materials

Frame in powder-coated steel. Modules in an FSC™-certified wood construction with foam and wadding. Fully upholstered with textile, imitation leather, or leather. The inside of the In Situ Cushion features a foam core with a pillowcase filled with fiber balls.

Certificates & Warranty

Strength & Stability: EN 16139 - L2, EN 1022, BIFMA X5.4. Eco Labels & Safety: VOC CDPH 01350* and BIFMA X7.1**, FSC™, Crib 5 upon request. Warranty: 10 years

Options

Back cushion in small or large.

Color Options & Codes

Upholstery: Textile, leather. See the wide selection in our digital Product Configurator and visit our Price List for a full overview.

Frame: Black (RAL 9011)

Ready-To-Ship Options

Ecriture 240 / Black



Clay 12 / Black



Dimensions

Across all modules

Height: 70 cm / 27.6"
Seat height: 38 cm / 15"
Armrest height: 22 cm / 8.7"

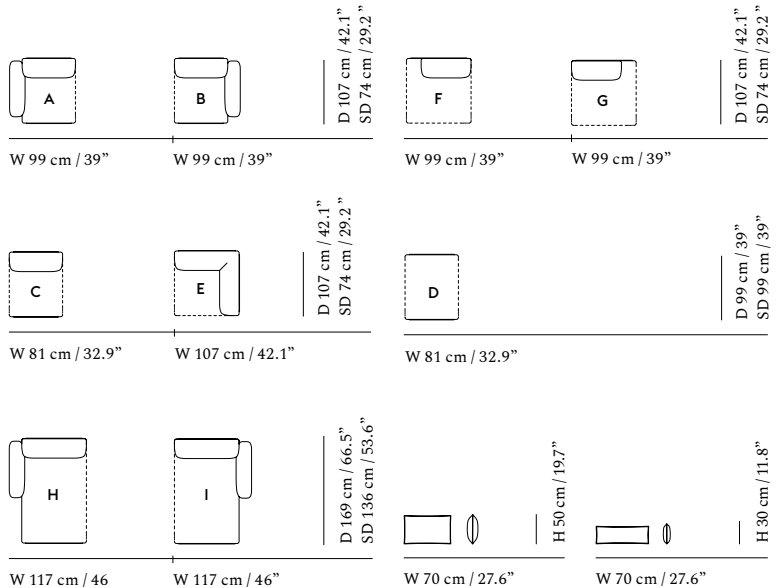
Cushion 70 x 50 cm

Width: 70 cm / 27.6"
Height: 50 cm / 19.7"

Cushion 70 x 30 cm

Width: 70 cm / 27.6"
Height: 30 cm / 11.8"

*Valid for a large selection of Kvadrat upholstery. Refine and Easy leather.
**Not valid for leather.



Create your own configuration



doze lounge chair & ottoman

by Anderssen & Voll

Designed with extensive comfort and a modern expression through the vibrant lines and folds of its back and armrests along with an embracing seat, the Doze Lounge Chairs join together the ideas of Scandinavian design with the lines of 1970s furniture for a contemporary perspective on the archetypal lounge chair.

160



Doze Lounge Chair High Back & Ottoman
— Tube Base

Materials

Welded metal construction, casted foam, wadding and upholstered with textile, imitation leather or leather. Tube base in chromed or powder-coated steel. Black plastic glides.

Certificates & Warranty

Strength & Stability: EN 16139 - L2, EN 1022, BIFMA X5.4. **Eco Labels & Safety:** VOC CDPH 01350* and BIFMA X7.1*, Crib 5 upon request.
Warranty: 10 years

Options

Felt glides.

Color Options & Codes

Upholstery: Textile, imitation leather, or leather. See the wide selection in our digital Product Configurator and visit our Price List for a full overview.
Legs: Anthracite Black (RAL 7021), Chrome, Grey (RAL 7044).

Ready-To-Ship Options

Upholstery / Legs

Ocean 80 / Anthracite Black

Refine Leather Cognac / Anthracite Black

Dimensions

Doze Lounge Chair High Back

Height:	106 cm / 41.7"
Width:	95,5 cm / 37.6"
Depth:	100 cm / 39.4"
Seat height:	40 cm / 15.8"
Seat depth:	52,5 cm / 20.7"
Seat width:	52,5 cm / 20.7"

Doze Ottoman

Height:	40 cm / 15.8"
Width:	64 cm / 25.2"
Depth:	52 cm / 20.5"



Doze Lounge Chair High Back & Ottoman
— Swivel Base

Materials

Welded metal construction, casted foam, wadding and upholstered with textile, imitation leather or leather. Swivel base in polished or powder-coated casted aluminum. Black plastic glides.

Certificates & Warranty

Strength & Stability: EN 16139 - L2, EN 1022, BIFMA X5.4. **Eco Labels & Safety:** VOC CDPH 01350* and BIFMA X7.1*, Crib 5 upon request.
Warranty: 10 years

Options

Felt glides.

Color Options & Codes

Upholstery: Textile, imitation leather, or leather. See the wide selection in our digital Product Configurator and visit our Price List for a full overview.
Legs: Anthracite Black (RAL 7021), Chrome, Grey (RAL 7044).

Ready-To-Ship Options

Upholstery / Legs

Ocean 80 / Anthracite Black

Refine Leather Cognac / Anthracite Black

Dimensions

Doze Lounge Chair High Back

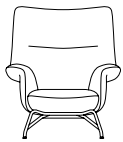
Height:	106 cm / 41.7"
Width:	95,5 cm / 37.6"
Depth:	100 cm / 39.4"
Seat height:	40 cm / 15.8"
Seat depth:	52,5 cm / 20.7"
Seat width:	52,5 cm / 20.7"

Doze Ottoman

Height:	40 cm / 15.8"
Width:	64 cm / 25.2"
Depth:	52 cm / 20.5"

*Valid for a large selection of Kvadrat upholstery, Refine and Easy leather.

seating



W 95,5 cm / 37.6"



D 100 cm / 39.4"

H 106 cm / 41.7"
SH 40 cm / 15.8"



W 64cm / 25.2"



D 52 cm / 20.5"

H 40 cm / 15.8"



W 95,5 cm / 37.6"



D 100 cm / 39.4"

H 106 cm / 41.7"
SH 40 cm / 15.8"



W 64cm / 25.2"



D 52 cm / 20.5"

H 40 cm / 15.8"

*Valid for a large selection of Kvadrat upholstery.
Refine and Easy leather.



W 95,5 cm / 37.6"



D 86 cm / 33.9"

H 78 cm / 30.7"
SH 40 cm / 15.8"



W 64cm / 25.2"



D 52 cm / 20.5"

H 40 cm / 15.8"



W 95,5 cm / 37.6"



D 86 cm / 33.9"

H 78 cm / 30.7"
SH 40 cm / 15.8"



W 64cm / 25.2"



D 52 cm / 20.5"

H 40 cm / 15.8"



Configurable

Doze Lounge Chair Low Back & Ottoman

— Tube Base

Materials

Welded metal construction, casted foam, wadding and upholstered with textile, imitation leather, or leather. Tube base in chromed or powder-coated steel. Black plastic glides.

Certificates & Warranty

Strength & Stability: EN 16139 - L2, EN 1022, BIFMA X5.4. **Eco Labels & Safety:** VOC CDPH 01350* and BIFMA X7.1*, Crib 5 upon request.
Warranty: 10 years

Options

Felt glides.

Color Options & Codes

Upholstery: Textile, imitation leather, or leather. See the wide selection in our digital Product Configurator and visit our Price List for a full overview. **Legs:** Anthracite Black (RAL 7021), Grey (7044), Chrome.

Ready-To-Ship Options

Upholstery/Legs

Ocean 80 / Anthracite Black



Refine Leather Cognac / Anthracite Black



Hearth 7 / Grey*



*Valid for Lounge Chair only

Dimensions

Doze Lounge Chair Low Back

Height:	78 cm / 30.7"
Width:	95,5 cm / 37.6"
Depth:	86 cm / 33.9"
Seat height:	40 cm / 15.8"
Seat depth:	52,5 cm / 20.7"
Seat width:	52,5 cm / 20.7"

Doze Ottoman

Height:	40 cm / 15.8"
Width:	64 cm / 25.2"
Depth:	52 cm / 20.5"



Configurable

Doze Lounge Chair Low Back & Ottoman

— Swivel Base

Materials

Welded metal construction, casted foam, wadding and upholstered with textile, imitation leather, or leather. Swivel base in polished or powder-coated casted aluminum. Black plastic glides.

Certificates & Warranty

Strength & Stability: EN 16139 - L2, EN 1022, BIFMA X5.4. **Eco Labels & Safety:** VOC CDPH 01350* and BIFMA X7.1*, Crib 5 upon request.
Warranty: 10 years

Options

Felt glides

Color Options & Codes

Upholstery: Textile, imitation leather, or leather. See the wide selection in our digital Product Configurator and visit our Price List for a full overview. **Legs:** Anthracite Black (RAL 7021), Grey (7044), Polished Aluminum.

Ready-To-Ship Options

Upholstery/Legs

Ocean 80 / Anthracite Black



Refine Leather Cognac / Anthracite Black



Hearth 7 / Grey*



*Valid for Lounge Chair only

Dimensions

Doze Lounge Chair Low Back

Height:	78 cm / 30.7"
Width:	95,5 cm / 37.6"
Depth:	86 cm / 33.9"
Seat height:	40 cm / 15.8"
Seat depth:	52,5 cm / 20.7"
Seat width:	52,5 cm / 20.7"

Doze Ottoman

Height:	40 cm / 15.8"
Width:	64 cm / 25.2"
Depth:	52 cm / 20.5"

wrap lounge chair

by Normal Studio

Wrap is a soft lounge chair with a blanket-like textile wrapped around its shell. With a generous shape supported by a light steel frame, it offers a deep comfort with a strong sense of character, ideal for the lobby, lounge or a minute of rest at the office.

162

seating



Wrap Lounge Chair

Materials

Shell of pressed felt with 100% recycled plastic from post-consumer waste and with a steel reinforcement. Multiple layers of foam and wadding and upholstered with textile. Tube base in powder coated steel. Black plastic glides.

Certificates & Warranty

Strength & Stability: EN 16139 - L2, BIFMA X5.4.

Eco Labels & Safety: VOC CDPH 01350* and BIFMA X7.1*, Crib 5 upon request.

Warranty: 10 years

Options

Felt glides.

Color Options & Codes

Upholstery: Textile. See the wide selection in our digital Product Configurator and visit our Price List for a full overview.

Legs: Black (RAL 9011), Grey (RAL 7044).

Ready-To-Ship Options

Upholstery / Legs

Sabi 151 / Black



Ecriture 240 / Grey



Dimensions

Height:	81,5 cm / 32"
Width:	91,3 cm / 36"
Depth:	91 cm / 35.8"
Seat height:	44,5 cm / 17.5"
Seat depth:	54 cm / 21.3"
Seat width:	50 cm / 19.7"



*Valid for a large selection of Kvadrat upholstery.



W 91,3 cm / 36"



D 91 cm / 35.8"

H 81,5 cm / 32"
SH 44,5 cm / 17.5"

echo pouf

by Anderssen & Voll

Designed with a simple, friendly expression, the Echo Pouf brings comfort and functionality to any space. Use the design in symmetric formations or clusters in various sizes and upholsteries to create visual echoes throughout a space.



Configurable

Echo Pouf

Materials

Wood frame and high-resilience foam with textile upholstery.

Certificates & Warranty

Strength & Stability: EN 16139 - L2, EN 1022, BIFMA X5.4. Eco Labels & Safety: VOC CDPH 01350* and BIFMA X7.1*, Crib 5 upon request.

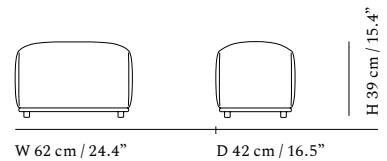
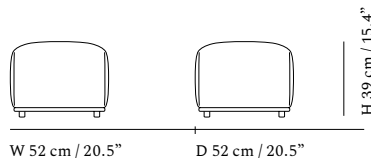
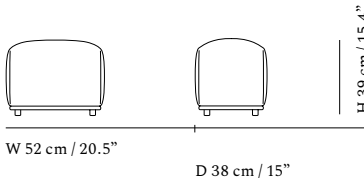
Warranty: 10 years

Color Options & Codes

Upholstery: Textile or imitation leather. See the wide selection in our digital Product Configurator and visit our Price List for a full overview.

Dimensions

Echo Pouf - 52 x 38 cm / 20.5 x 15"	
Height:	39 cm / 15.4"
Width:	52 cm / 20.5"
Depth:	38 cm / 15"
Foot height:	3 cm / 1.2"
Echo Pouf - 52 x 52 cm / 20.5 x 20.5"	
Height:	39 cm / 15.4"
Width:	52 cm / 20.5"
Depth:	52 cm / 20.5"
Foot height:	3 cm / 1.2"
Echo Pouf - 62 x 42 cm / 24.4 x 16.5"	
Height:	39 cm / 15.4"
Width:	62 cm / 24.4"
Depth:	42 cm / 16.5"
Foot height:	3 cm / 1.2"



five pouf

by Anderssen & Voll

The Five Pouf's quilted ribs are wrapped around the shape of the pouf, enhancing the dynamic of its pentagon form. Use the Five Pouf alone or grouped in a lounge space, creating a unique look by mixing and matching different sizes and upholsteries.



Configurable

Five Pouf

Materials

Wooden frame and molded foam with textile upholstery. Black plastic glides.

Certificates & Warranty

Strength & Stability: EN 16139 - L2, EN 1022, BIFMA X5.4. Eco Labels & Safety: VOC CDPH 01350* and BIFMA X7.1*, Crib 5 upon request.

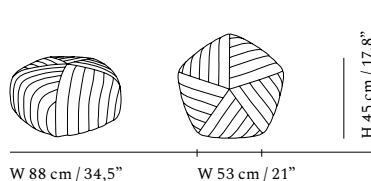
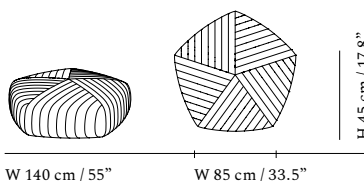
Warranty: 10 years

Color Options & Codes

Upholstery: Textile. See the wide selection in our digital Product Configurator and visit our Price List for a full overview.

Dimensions

Five Pouf - Large	
Side width:	53 cm / 21"
Total width:	88 cm / 34.5"
Height:	45 cm / 17.75"
Five Pouf - Extra Large	
Side width:	85 cm / 33.5"
Total width:	140 cm / 55"
Height:	45 cm / 17.75"



*Valid for a large selection of Kvadrat upholstery.

The Linear System Series offers a new perspective on the evolving needs of the modern workspace, hospitality settings and educational institutions, offering configurable design across tables, lighting, screens and trays alongside a custom integrated power solution. These qualities enable you to tailor the design to your specific needs. Designed in oak, a traditional Scandinavian material, the series brings feelings of home and familiarity to any space. Unique configurability means that the Linear System Series can be used to create larger settings as well as intimate, smaller spaces for both solo-working and collaborative sessions.

linear



system

series

by Thomas Bentzen



Tailor the Linear System Table to your exact needs by choosing between a freestanding table, predesigned configurations or design your own through the modular options. Add the accessories, lighting, power outlets, cable trays and power solutions fit for optimal use. Explore the endless possibilities with the Linear System Series Product Planner.

I. Table

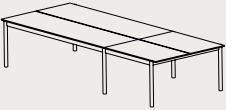
Select either predesigned table configurations or create your own table configuration

A. Predesigned table configurations

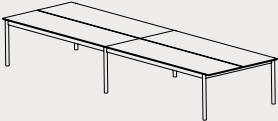
Table



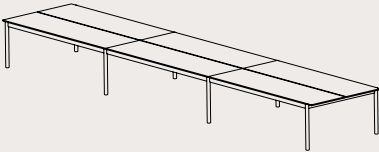
Config. 1



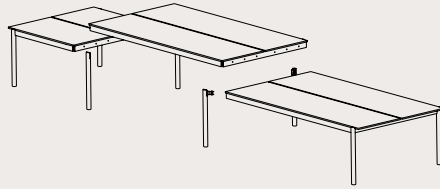
Config. 2



Config. 3



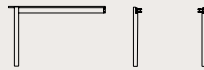
B. Create your own configuration with modules



End Modules



Connecting Legs

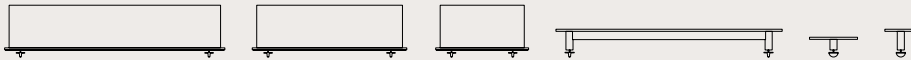


Middle Module



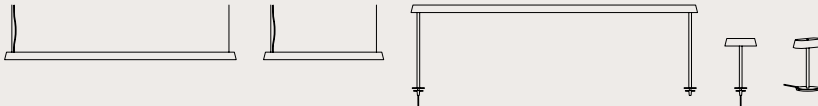
2. Accessories

Select Trays and Screens



3. Lighting

Select either Pendant, Mounted or Table Lamps



4. Power Outlet

Select Table Power Outlet

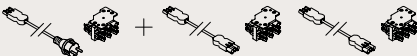


5. Integrated Power Solution

Select readymade power configurations or add power to your own table configuration

A. Readymade Power Configurations

Configuration 3 (example)



B. Create your own configuration

Power Kit

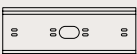


Power Extension Kit



6. Cable Tray

Select Cable Tray



linear system table

by Thomas Bentzen

Choose between a single freestanding table or one of our predesigned table configurations, adding lamps and accessories to fit.

*Different finishes of tabletops cannot be mixed as they might vary in thickness.



Linear System Series

— Across all tables, configurations & modules

Materials

Tabletop in Oak Veneer, Black version in Ash Veneer or Black Nanolaminate. Black Nanolaminate has an ABS edge. For Oak versions slight color variation can occur. Table frame in veneered plywood and legs in Solid Oak. Adjustable feet with felt glides.

Certificates & Warranty

Strength & Stability: EN 15372 - L3. Eco Labels & Safety: VOC CDPH 01350* and BIFMA X7.1*.

*Incl. Screens, Trays, Lighting and Power Outlets. For Black Nanolaminate and Black Lacquered Ash Veneer versions, BIFMA X7.1 is only valid in private office use.

Warranty: 5 years

Options

Screens, Trays, Lighting, Table Power Outlet, Power Kit and Cable Tray.

Ready-To-Ship Options

Tabletop / Frame & Legs

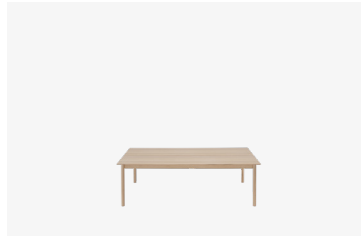
Oak Veneer / Oak	
Black Nanolaminate / Black ABS / Oak	
Black Lacquered Ash Veneer / Black	
Black Nanolaminate / Black ABS / Black	

Color Options & Codes*

Tabletop: Oak, Black, Black Nanolaminate (RAL 000 25 00).

Frame & Legs: Oak, Black

Configuration Options



Table



Config. 1



Config. 2



Config. 3

Dimensions

Linear Table

Height:	74 cm / 29"
Length:	240 cm / 94.5"
Width:	146,9 cm / 57.8"

Linear — Config. 1

Height:	74 cm / 29"
Length:	360 cm / 141.7"
Width:	146,9 cm / 57.8"

Linear — Config. 2

Height:	74 cm / 29"
Length:	480 cm / 189"
Width:	146,9 cm / 57.8"

Linear — Config. 3

Height:	74 cm / 29"
Length:	720 cm / 283.5"
Width:	146,9 cm / 57.8"



Create your own Linear System configuration from scratch and add lamps and accessories according to the exact need of your space.



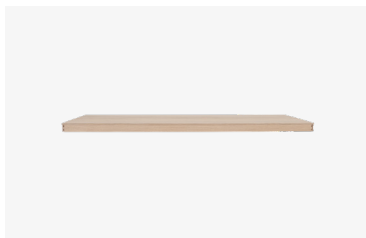
Module Options



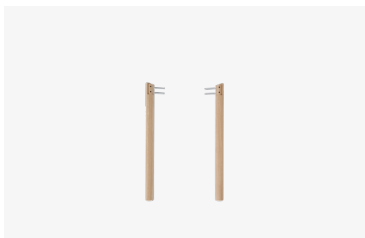
End Module — 120 cm / 47.2"



End Module — 240 cm / 94.5"



Middle Module — 240 cm / 94.5"



Legs



Dimensions

End Module — 120 cm / 47.2"

Height: 74 cm / 29"
Length: 120 cm / 47.2"
Width: 146,9 cm / 57.8"

End Module — 240 cm / 94.5"

Height: 74 cm / 29"
Length: 240 cm / 94.5"
Width: 146,9 cm / 57.8"

Middle Module — 240 cm / 94.5"

Length: 240 cm / 94.5"
Width: 146,9 cm / 57.8"

Legs

Height: 74 cm / 29.1"
Diameter: Ø 5,3 cm / 2.1"

linear lamp series

by Thomas Bentzen

The Linear Lamp Series is designed to create smaller atmospheres, bringing a sense of intimacy to larger spaces. Add modern lighting to your Linear System design, choosing between the Pendant Lamps, Mounted Lamps and Table Lamp.

168



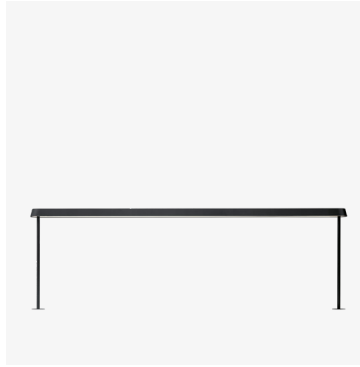
Linear System Series
— Across all lamps

Materials

Lampshades in powder coated, pressure die casted aluminum. Stem in powder coated steel with diffuser in polycarbonate. PVC Cord. Mounted Lamps are mounted with powder coated aluminum fixing knobs.




Ready-To-Ship Options

- Black (RAL 9011)
- Grey (RAL 7044)



Linear Mounted Lamp
— 209,2 cm / 82.4"

Specifications

Integrated, dimmable, non-replaceable LED: 58,9W (must be mounted to the Power Solution, see p. 161). 3000K, 3 step. 2700 lumen. Lumen maintenance of 48.000 hours. **IP20**   

Energy Classification
G




Dimensions

Height: 70,7 cm / 27.8"
Width: 209,2 cm / 82.4"
Cord & wire length: 400 cm / 157.5"



Linear Mounted Lamp
— 23,2 cm / 9.1"

Specifications

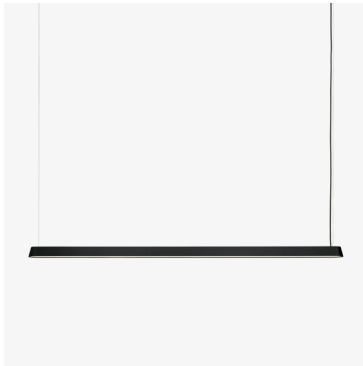
Integrated, dimmable, non-replaceable LED: 6,25W (must be mounted to the Power Solution, see p. 161). 3000K, 3 step. 242 lumen. Lumen maintenance of 48.000 hours. **IP20**   

Energy Classification
G

Dimensions




Height: 36,5 cm / 14.4"
Width: 23,2 cm / 9.1"
Cord & wire length: 150 cm / 59"

tables



Linear Pendant Lamp
— 169,2 cm / 66.6"

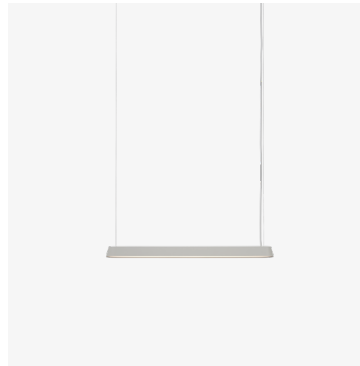
Specifications

White ceiling cap included. Integrated, non-replaceable LED bulb. 37,7W / 3000K, 3 steps. 1880 lm. Lumen maintenance of 48.000 hours. **IP20**   

Energy Classification
G




Dimensions

Height: 5,4 cm / 2.1"
Width: 169,2 cm / 66.6"
Cord & wire length: 400 cm / 157.5"



Linear Pendant Lamp
— 87,2 cm / 34.3"

Specifications

White ceiling cap included. Integrated, non-replaceable LED bulb. 20,3W / 3000K, 3 steps. 1060 lm. Lumen maintenance of 48.000 hours. **IP20**   

Energy Classification
G




Dimensions

Height: 5,4 cm / 2.1"
Width: 87,2 cm / 34.3"
Cord & wire length: 400 cm / 157.5"



Linear Table Lamp
— 23,2 cm / 9.1"

Specifications

Integrated, dimmable, non-replaceable LED bulb. 6,25W / 3000K, 3 steps. 242 lm. Lumen maintenance of 48.000 hours. The design features a built-in 18W USB-C plug for charging electrical devices. **IP20**   

Energy Classification
G

Dimensions

Height: 36,5 cm / 14.4"
Width: 23,2 cm / 9.1"
Cord length: 250 cm / 98.4"

linear system accessories

by Thomas Bentzen

Use the Linear System Screen and Tray to create smaller spaces within a larger setting. Bring a sense of home to any setting by storing objects on either side of the Screen or the plateau of the Tray. The Screen can be used freestanding or mounted while Tray must be mounted onto the Linear System Series design.



Screen
— 178 cm / 70.1"

Materials

Screens in solid oak and oak veneer with powder coated aluminum fixing knobs. For Oak versions slight color variation can occur. Possibility of upholstery on Screens.

Ready-To-Ship Options

- Oak ●
- Black ●

Dimensions

Height: 35 cm / 13.8"
Width: 178 cm / 70.1"



Screen
— 125 cm / 49.2"

Materials

Screens in solid oak and oak veneer with powder coated aluminum fixing knobs. For Oak versions slight color variation can occur. Possibility of upholstery on Screens.

Ready-To-Ship Options

- Oak ●
- Black ●

Dimensions

Height: 35 cm / 13.8"
Width: 125 cm / 49.2"



Screen
— 75 cm / 29.5"

Materials

Screens in solid oak and oak veneer with powder coated aluminum fixing knobs. For Oak versions slight color variation can occur. Possibility of upholstery on Screens.

Ready-To-Ship Options

- Oak ●
- Black ●

Dimensions

Height: 35 cm / 13.8"
Width: 75 cm / 29.5"



Tray
— 170 cm / 66.9"

Materials

Tray 170 cm in solid oak and oak veneer, with powder coated aluminum fixing knobs. For Oak versions slight color variation can occur.

Ready-To-Ship Options

- Oak ●
- Black ●

Dimensions

Height: 15 cm / 5.9"
Width: 170 cm / 66.9"



Tray
— Ø 36 cm / 14.2"

Materials

Tray Ø36 in solid oak with powder coated aluminum fixing knobs.

Ready-To-Ship Options

- Oak ●
- Black ●

Dimensions

Height: 9,6 cm / 3.8"
Diameter: Ø 36 cm / 14.2"



Tray
— Ø 24 cm / 9.5"

Materials

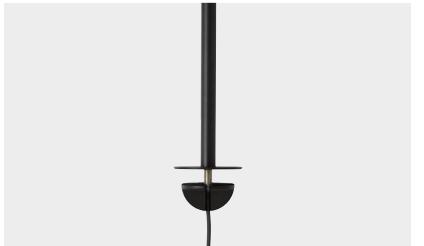
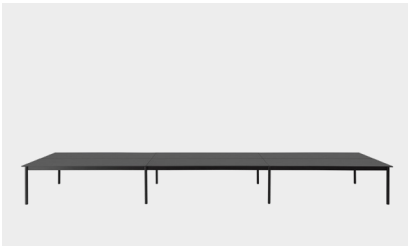
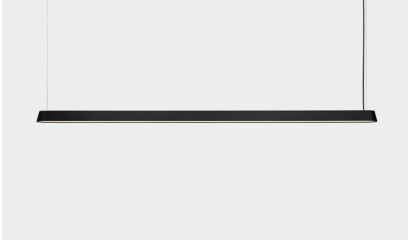
Tray Ø24 in solid oak with powder coated aluminum fixing knobs.

Ready-To-Ship Options

- Oak ●
- Black ●

Dimensions

Height: 15,6 cm / 6.2"
Diameter: Ø 24 cm / 9.5"



linear system power solution

by Thomas Bentzen

The Linear System Series features a tailor-made Power Solution for all Linear Mounted Lamps and Power Outlets, allowing for all cables to be seamlessly integrated.



Linear System Table Power Outlet

With its minimalistic design, the Power Outlets become decorative elements placed across the Linear System Table. The Table Power Outlet can be mounted on the table and has two outlets to which standard plugs can be connected as well as a USB-A and USB-C plug. Must be connected to the Power Solution.

Materials

Powder coated steel cover, plastic plugs, powder coated aluminum fixing knob.

Specifications

IP20 CE

Options

Available as region-specific version for EU and UK. The Table Power Outlet fits for Type C (Euro plug), Type F (Schuko) and Type E. Special requests upon request.

Ready-To-Ship Options

- Black
- Grey

Dimensions

Height: 7 cm / 2.8"
Width: 7 cm / 2.8"
Depth: 18 cm / 7.1"
Cord length: 150 cm / 59"



Power Kit & Power Extension Kit

Each Power Kit has five outlets to which up to five Linear Mounted Lamps or Linear Table System Power Outlets can be plugged in.

If you've chosen a predesigned table configuration (Linear System Table, Config.1, Config.2 or Config.3), simply select the matching readymade power configuration. If you have created your own table configuration from scratch with the individual modules, select a Power Kit and add a Power Extension Kit for every table module added. For more guidance, visit the how-to-order guide in the price list.

Materials

Table Power Kit cord in PVC and nylon distribution plugs.

Specifications

IP20 CE

Ready-To-Ship Options

- Black

Dimensions

Start Kit: 150 cm / 59"
Power Extension Kit: 200 cm / 78.7"
Power Extension Kit: 250 cm / 98.4"



Cable Tray

Cables are stored in the Cable Tray, which is mounted underneath the table.

Materials

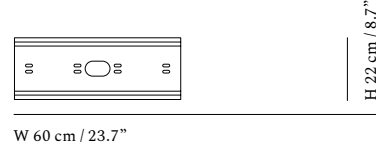
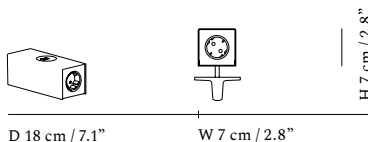
Cable Tray in recycled PET felt.

Ready-To-Ship Options

- Dark Grey

Dimensions

Height: 3 cm / 1.2"
Width: 22 cm / 8.7"
Length: 60 cm / 23.7"

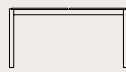


linear series system

by Thomas Bentzen

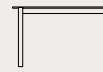


Table
L 240 cm / 94,5"



W 146,9 cm / 57.8"

H 74 cm / 29.1"



End Module
L 120 cm / 47.2"

H 74 cm / 29.1"



Config. 1
L 360 cm / 141.7"



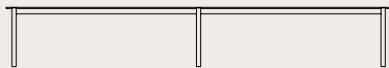
W 146,9 cm / 57.8"

H 74 cm / 29.1"

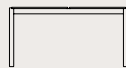


End Module
L 240 cm / 94.5"

H 74 cm / 29.1"



Config. 2
L 480 cm / 189"



W 146,9 cm / 57.8"

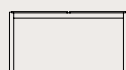
H 74 cm / 29.1"



Middle Module
L 240 cm / 94.5"



Config. 3
L 720 cm / 283.5"



W 146,9 cm / 57.8"

H 74 cm / 29.1"



Legs

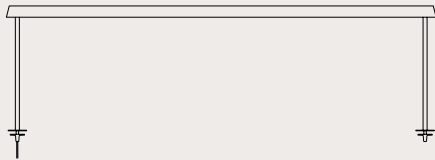
H 74 cm / 29.1"



Linear Pendant Lamp — 87,2 cm / 34.3"
W 87,2 cm / 34.3"



Linear Pendant Lamp — 169,2 cm / 66.6"
W 169,2 cm / 66.6"



Linear Mounted Lamp — 209,2 cm / 82.4"
W 209,2 cm / 82.4"



Linear Mounted Lamp — 23,2 cm / 9.1"
W 23,2 cm / 9.1"



Linear Table Lamp — 23,2 cm / 9.1"
W 23,2 cm / 9.1"

H 5,4 cm / 2.1"

H 5,4 cm / 2.1"

H 70,7 cm / 27.8"

H 36,5 cm / 14.4"

H 36,5 cm / 14.4"



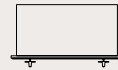
Linear System Tray — Ø 24 cm / 9.5"
Ø 24 cm / 9.5"



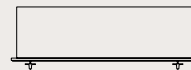
Linear System Tray — Ø 36 cm / 14.2"
Ø 36 cm / 14.2"



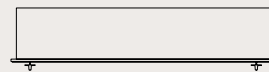
Linear System Tray — 170 cm / 66.9"
W 170 cm / 66.9"



Linear System Screen — 75 cm / 29.5"
W 75 cm / 29.5"



Linear System Screen — 125 cm / 49.2"
W 125 cm / 49.2"



Linear System Screen — 178 cm / 70.1"
W 178 cm / 70.1"



W 24 cm / 9.5"



W 36 cm / 14.2"



W 21 cm / 8.3"

H 15,6 cm / 6.2"

H 9,6 cm / 3.8"

H 15 cm / 5.9"

H 35 cm / 13.8"

H 35 cm / 13.8"

H 35 cm / 13.8"

linear wood series

by Thomas Bentzen

The Linear Wood Series brings a simple and elegant perspective to wood-en furniture through its modern form language. The design is defined by its straight lines for a contemporary yet honest aesthetic through the details of its thinly elegant overhang and halfcircular intersecting legs.



Linear Wood Bench

Materials

Bench top in lacquered oak veneer with legs in solid oak. Wood is a natural material, and this means that slight color variation can occur.

Certificates & Warranty

Strength & Stability: EN 16139 - L2, EN 1022, BIFMA X5.4. Eco Labels & Safety: VOC CDPH 01350 and BIFMA X7.1. Warranty: 10 years

Options

Custom sizes.

Color Options

Oak

Ready-To-Ship Options

Tabletop/Legs

Oak Veneer / Oak

Dimensions

110 x 34 cm / 43.3 x 13.4"

Length: 110 cm / 43.3"
Total width: 39,4 cm / 15.5"
Seat width: 34 cm / 13.4"
Height: 46 cm / 18.1"

170 x 34 cm / 66.9 x 13.4"

Length: 170 cm / 66.9"
Total width: 39,4 cm / 15.5"
Seat width: 34 cm / 13.4"
Height: 46 cm / 18.1"

140 x 34 cm / 55.1 x 13.4"

Length: 140 cm / 55.1"
Total width: 90,3 cm / 35.5"
Seat width: 74 cm / 29.1"
Height: 74 cm / 29.1"

200 x 34 cm / 78.7 x 13.4"

Length: 200 cm / 78.7"
Total width: 95,3 cm / 37.5"
Seat width: 74 cm / 29.1"
Height: 74 cm / 29.1"

260 x 34 cm / 102.4 x 13.4"

Length: 260 cm / 102.4"
Total width: 95,3 cm / 37.5"
Seat width: 74 cm / 29.1"
Height: 74 cm / 29.1"



Linear Wood Table

Materials

Tabletop in lacquered oak veneer with legs in solid oak. Wood is a natural material, and this means that slight color variation can occur.

Certificates & Warranty

Strength & Stability: EN 15372 - L3. Eco Labels & Safety: VOC CDPH 01350 and BIFMA X7.1. Warranty: 5 years

Options

Custom sizes.

Color Options

Oak

Ready-To-Ship Options

Tabletop/Legs

Oak Veneer / Oak

Dimensions

140 x 85 cm / 55.1 x 31.5"

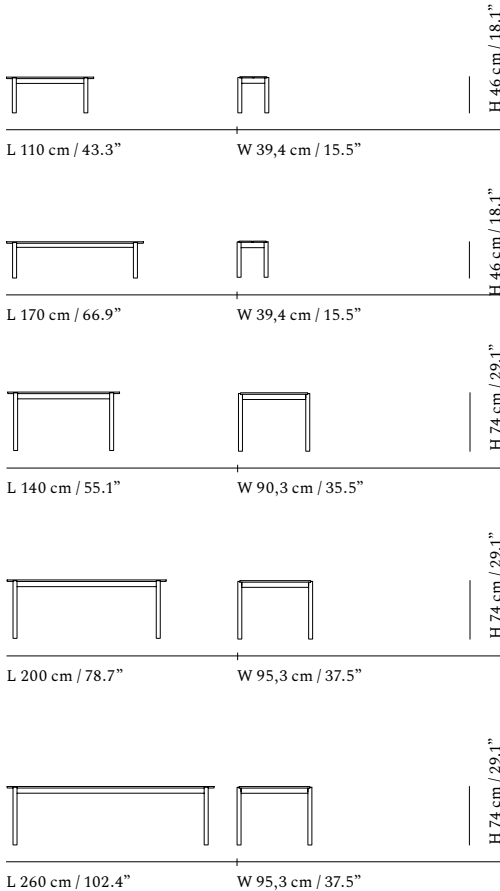
Length: 140 cm / 55.1"
Total width: 90,3 cm / 35.5"
Tabletop width: 85 cm / 31.5"
Height: 74 cm / 29.1"
Height to apron: 65,5 cm / 25.8"

200 x 90 cm / 78.7 x 35.4"

Length: 200 cm / 78.7"
Total width: 95,3 cm / 37.5"
Tabletop width: 90 cm / 35.4"
Height: 74 cm / 29.1"
Height to apron: 65,5 cm / 25.8"

260 x 90 cm / 102.4 x 35.4"

Length: 260 cm / 102.4"
Total width: 95,3 cm / 37.5"
Tabletop width: 90 cm / 35.4"
Height: 74 cm / 29.1"
Height to apron: 65,5 cm / 25.8"



midst table

by TAF Studio

A natural focal point of any room - the restaurant or meeting room - the **Midst Table** is a generous, round dining table to gather around, and there is always room to squeeze in one more. Its refined silhouette is simple yet characteristic, enhanced by distinct detailing and contrasting materiality.



Midst Table

Materials

Tabletop in lacquered MDF with a linoleum top or FSC™-certified solid oak, treated with either a clear or dark oil. Base in powdercoated steel with a protective rubber ring under the base.

Certificates & Warranty

Strength & Stability: BIFMA X5.5. EN 15372-L3

Eco Labels & Safety: FSC™.

*Valid for solid oak tabletop.

Warranty: 10 years

Color Options & Codes

Tabletop: Black (Forbo - Nero 4023), Dark Red (Forbo - Burgundy 4154), Dark Oiled Oak, Solid Oak.

Base: Black (RAL 9005), Grey (RAL 7044), Dark Red (RAL 8017).

Ready-To-Ship Options

Tabletop/Base

Black / Black	● ●
Dark Oiled Oak / Black	● ●
Dark Oiled Oak / Grey	● ●
Dark Oiled Oak / Dark Red	● ●
Oak / Black	● ●
Oak / Grey	● ●
Oak / Dark Red	● ●
Dark Red / Dark Red	● ●

Dimensions

Ø120 cm / 47.24"

Diameter: 120 cm / 47.24"

Height: 73 cm / 27.74"

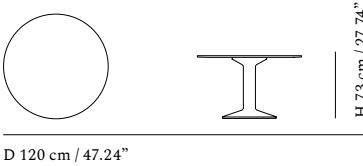
Tabletop height: 2,5 cm / 0.98"

Ø160 cm / 62.99"

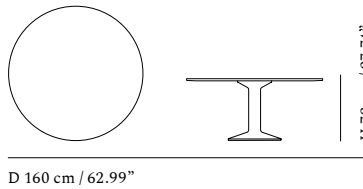
Diameter: 160 cm / 62.99"

Height: 73 cm / 27.74"

Tabletop height: 2,5 cm / 0.98"



D 120 cm / 47.24"



D 160 cm / 62.99"

workshop table

by Cecilie Manz

The **Workshop Table** joins together the ideas of Scandinavian craftsmanship and subtle detailing, making for a deliberately simple and archetypal expression in a modern dining table. With its tabletop in either oak veneer or linoleum harmoniously carving itself into the frame of solid oak, the **Workshop Table** brings a refined and understated appearance to any space.



Workshop Table

Materials

Tabletop in lacquered oak veneer or linoleum.

For Oak versions slight color variation can occur.

Legs and frame in lacquered solid oak.

Certificates & Warranty

Strength & Stability: EN 15372 - L3. BIFMA X5.5.

Eco Labels & Safety: VOC BIFMA X7.1

Warranty: 10 years

Color Options & Codes

Tabletop: Oak, Warm Grey Linoleum (Forbo 4176), Black Linoleum (Forbo 4023)

Frame/Legs: Oak, Black (RAL 9005).

Ready-To-Ship Options

Oak Veneer/Oak*	● ●
Warm Grey Linoleum/Oak	● ●
Black Linoleum/Black	● ●

*not available in 130 x 65 cm / 51.2 x 25.6"

Dimensions

130 x 65 cm / 51.2 x 25.6" 140 x 92 cm / 55.1 x 36.2"

Length: 130 cm / 51.2" Length: 140 cm / 55.1"

Width: 65 cm / 25.6" Width: 92 cm / 36.2"

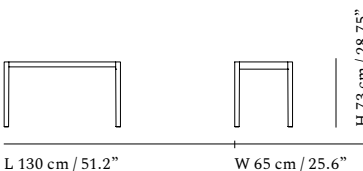
Height: 73 cm / 28.7" Height: 73 cm / 28.7"

900 x 92 cm / 78.7 x 36.2"

Length: 200 cm / 78.7"

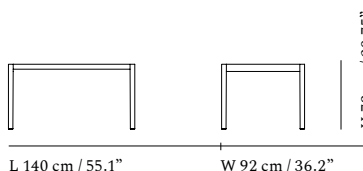
Width: 92 cm / 36.2"

Height: 73 cm / 28.7"



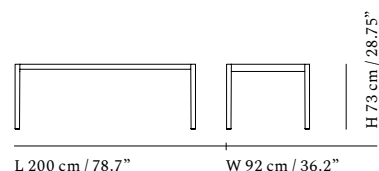
L 130 cm / 51.2"

W 65 cm / 25.6"



L 140 cm / 55.1"

W 92 cm / 36.2"



L 200 cm / 78.7"

W 92 cm / 36.2"

70/70 table

by TAF Studio

The 70/70 Table has a simple expression with refined details. The design combines a slender tabletop with a solid, triangular frame. Available in four different sizes, the table adds a contemporary touch to any setting.

176



70/70 Table

Materials

Tabletop in lacquered oak veneer, Black and Grey version in plywood with linoleum surface, White and Sand version in plywood with laminate surface (HPL). Solid Oak or Solid Smoked Oak tabletop in FSC™-certified oak. For Oak versions slight color variation can occur. Frame in powder coated aluminum.

Certificates & Warranty

Strength & Stability: EN 15372 - L3, BIFMA X5.5.
Eco Labels & Safety: VOC CDPH 01350* and BIFMA X7.1*. Tabletops using FSC™-certified oak*.
 *Valid for Solid Oak & Solid Smoked Oak. VOC BIFMA X7.1 is also valid for Veneer versions.
Warranty: 10 years

Options

Power Outlet. Cable Management kit. Chair hanger for Visu Chairs. Non-standard sized tables with max. width of 110 cm / 43.3", min. width of 80 cm / 31.5", max. length of 295 cm / 116.1" and min. length of 140 cm / 55.1".

Color Options & Codes

Tabletop: Black Linoleum (Forbo 4023), Grey Linoleum (Forbo 4175), White Laminate (Formica F1040), Sand (Formica F2833), Oak Veneer, Solid Oak, Solid Smoked Oak. **Frame:** Black (RAL 9004), Grey (RAL 7030), White (RAL 9016) Sand (NCS S 2010-Y30R)

Ready-To-Ship Options

Tabletop

- Oak Veneer
- Black Linoleum
- Grey Linoleum
- White Laminate
- Sand Laminate*
- Solid Oak
- Solid Smoked Oak

*Subject to stock availability across sizes.

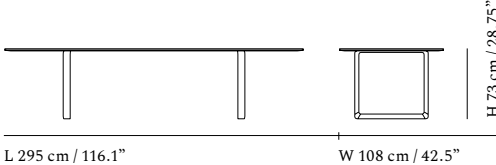
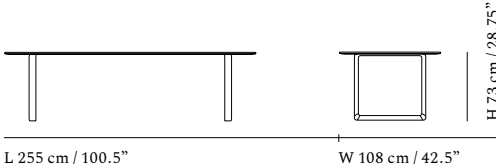
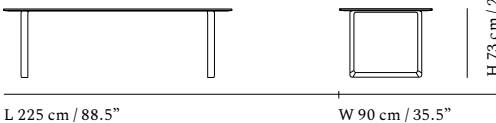
Frame

- Black
- White
- Grey
- Sand

Dimensions

170 x 85 cm / 67 x 33.5"	
Length:	170 cm / 67"
Width:	85 cm / 33.5"
Height:	73 cm / 28.75"
Tabletop height:	2,5-3,7 cm / 1-1.5"
Length between legs:	120 cm / 47.2"
<hr/>	
225 x 90 cm / 88.5 x 35.5"	
Length:	225 cm / 88.5"
Width:	90 cm / 35.5"
Height:	73 cm / 28.75"
Tabletop height:	2,5-3,7 cm / 1-1.5"
Length between legs:	175 cm / 68.9"
<hr/>	
255 x 108 cm / 100.5 x 42.5"	
Length:	255 cm / 100.5"
Width:	108 cm / 42.5"
Height:	73 cm / 28.75"
Tabletop height:	2,5-3,7 cm / 1-1.5"
Length between legs:	205 cm / 80.7"
<hr/>	
295 x 108 cm / 116.1 x 42.5"	
Length:	295 cm / 116.1"
Width:	108 cm / 42.5"
Height:	73 cm / 28.75"
Tabletop height:	2,5-3,7 cm / 1-1.5"
Length between legs:	176 cm / 69.3"

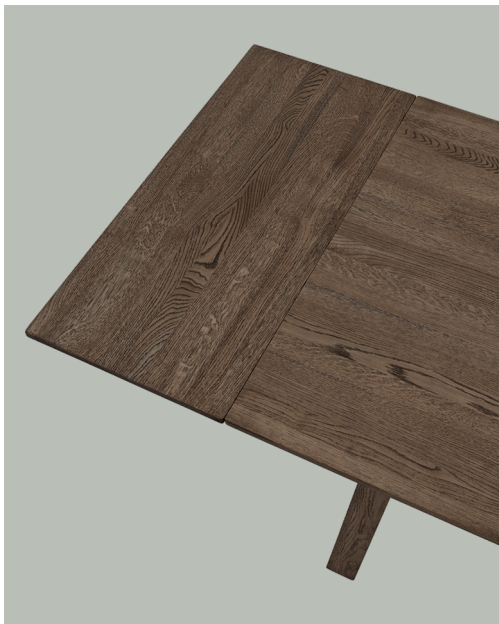
tables



earnest extendable table

by John Tree

The Earnest Extendable Table brings new perspectives to the timeless Scandinavian wood table. The table extends with manual apron pulls and a secure lock, all crafted in solid oak, seamlessly concealing its dual functionality. Available in two sizes, the smaller size comfortably fits 6 seats, expanding to 10, while the larger version accommodates 8 and extends to 12 seats — keeping the same shape once extended. Pairs perfectly with all Muuto chairs.



Earnest Extendable Table

Material

Tabletop and base from FSC™-certified solid oak, treated with either a clear or a dark oil. Plastic glides.

Certificates & Warranty

Strength & Stability: EN 15372-L3

Eco Labels & Safety: FSC™

Warranty: 5 years

Options

Extension leaves (set of 2) 100x44 cm / 39.37x17.32"

Dimensions

205x100 cm / 80.71 x 39.37"

Length: 205 cm / 80.71"

Width: 100 cm / 39.37"

Height: 73 cm / 28.7"

Length between legs: 147,3 cm / 57.99"

260x100 cm / 102.36 x 39.37"

Length: 260 cm / 102.36"

Width: 100 cm / 39.37"

Height: 73 cm / 28.7"

Length between legs: 192,3 cm / 75.71"

Color Options & Codes

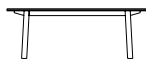
Oiled Oak, Dark Oiled Oak

Ready-To-Ship Options

Oiled Oak



Dark Oiled Oak

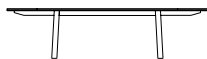


L 205 cm / 80.71"



W 100 cm / 39.37"

H 73 cm / 28.74"

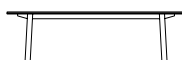


With extension leaves
L 293 cm / 115.35"



W 100 cm / 39.37"

H 73 cm / 28.74"



L 260 cm / 102.36"



W 100 cm / 39.37"

H 73 cm / 28.74"



With extension leaves
L 348 cm / 137.01"



W 100 cm / 39.37"

H 73 cm / 28.74"



Extension leaf:
L 44 cm / 17.32"

W 100 cm / 39.37"

base table series

by Mika Tolvanen

Base Table has a simple, timeless expression that allows for it to complement any area. Designed for daily use, the Base Table has an aluminum frame with an extra durable acrylic powder coating, paired with the subtle touch of its veneer edge for a refined design. Available with and without castors.



Configurable

Base Table

Materials

Frame and legs from extruded aluminum with powder coating. Tabletops with a laminate surface (HPL) with either ABS edges or plywood edges. Tabletops with a black linoleum surface or oak veneer surface with plywood edges in water-based lacquer. For Oak versions slight color variation can occur.

Certificates & Warranty

Strength & Stability: EN 15372 - L3, BIFMA X5.5*
*Not valid for L300 cm and L440 cm variants.

Eco Labels & Safety: VOC BIFMA X7.1*.

*Valid for Veneer variants

Warranty: 10 years. 5 years on L300 cm and L440 cm variants.

Options

Cable Management kit. Adjustable feet screws. Custom sizes. Minimum - maximum length for made-to-order variants: 70 - 440 cm / 27.6" - 173.2". Minimum - maximum width for made-to-order variants: 70 - 120 cm / 27.6" - 47.2".

Color Options & Codes

Tabletop: Oak Veneer, White laminate (RAL 9016), White Nanolaminate (RAL), Black linoleum (RAL 9005), Black laminate (RAL 9005), Black Nanolaminate (RAL).

Frame/Legs: White (RAL 9016), Black (RAL 9005).

Ready-To-Ship Options

Tabletop/Edge/Frame

White / White / White	<input type="radio"/> <input type="radio"/> <input type="radio"/>
White / White / Black	<input type="radio"/> <input type="radio"/> <input checked="" type="radio"/>
White / Plywood / White	<input type="radio"/> <input checked="" type="radio"/> <input type="radio"/>
White / Plywood / Black	<input type="radio"/> <input checked="" type="radio"/> <input checked="" type="radio"/>
Black Linoleum / Plywood / White	<input checked="" type="radio"/> <input checked="" type="radio"/> <input type="radio"/>
Black Linoleum / Plywood / Black	<input checked="" type="radio"/> <input checked="" type="radio"/> <input checked="" type="radio"/>
Lacquered Oak Veneer / Plywood / White	<input checked="" type="radio"/> <input checked="" type="radio"/> <input type="radio"/>
Lacquered Oak Veneer / Plywood / Black	<input checked="" type="radio"/> <input checked="" type="radio"/> <input checked="" type="radio"/>

Dimensions

Ready-To-Ship Dimensions

140 x 80 cm / 55 x 31.5"
190 x 85 cm / 74.75 x 33.5"
250 x 90 cm / 98.5 x 35.5"
Tabletop height: 1,5 cm / 0.5"



Configurable

Base Table w. Castors

Materials

Frame and legs from extruded aluminum with powder coating, with matching castors. Tabletops with a laminate surface (HPL) with either ABS edges or plywood edges. Tabletops with a black linoleum surface or oak veneer surface with plywood edges in water-based lacquer. For Oak versions slight color variation can occur.

Certificates & Warranty

Strength & Stability: EN 15372 - L3, BIFMA X5.5*

*Not valid for L300 cm and L440 cm variants.

Eco Labels & Safety: VOC BIFMA X7.1*.

*Valid for Veneer variants

Warranty: 10 years. 5 years on L300 cm and L440 cm variants.

Options

Cable Management kit. Adjustable feet screws. Custom sizes. Minimum - maximum length for made-to-order variants: 70 - 440 cm / 27.6" - 173.2". Minimum - maximum width for made-to-order variants: 70 - 120 cm / 27.6" - 47.2".

Color Options & Codes

Tabletop: Oak Veneer, White laminate (RAL 9016), White Nanolaminate (RAL), Black linoleum (RAL 9005), Black laminate (RAL 9005), Black Nanolaminate (RAL).

Frame/Legs: White (RAL 9016), Black (RAL 9005).



Configurable

Base High Table

Materials

Frame and legs from steel and extruded aluminum with powder coating. Tabletops with a laminate surface (HPL) with either ABS edges or plywood edges. Tabletops with a black linoleum surface or oak veneer surface with plywood edges in water-based lacquer. For Oak versions slight color variation can occur.

Certificates & Warranty

Strength & Stability: EN 15372 - L3, BIFMA X5.5*

*Not valid for L300 cm and L440 cm variants.

Eco Labels & Safety: VOC BIFMA X7.1*.

*Valid for Veneer variants

Warranty: 10 years. 5 years on L300 cm and L440 cm variants.

Options

Cable Management kit. Adjustable feet screws. A selection of finishes and non-standard sizes are made-to-order. Minimum - maximum length for made-to-order variants: 70 - 440 cm / 27.6" - 173.2". Minimum - maximum width for made-to-order variants: 50 - 120 cm / 19.7" - 47.2".

Color Options & Codes

Tabletop: Oak Veneer, White laminate (RAL 9016), White Nanolaminate (RAL), Black linoleum (RAL 9005), Black laminate (RAL 9005), Black Nanolaminate (RAL). **Frame/Legs:** White (RAL 9016), Black (RAL 9005).

Ready-To-Ship Options

Tabletop/Edge/Frame

White / White / White	<input type="radio"/> <input type="radio"/> <input type="radio"/>
White / White / Black	<input type="radio"/> <input type="radio"/> <input checked="" type="radio"/>
White / Plywood / White	<input type="radio"/> <input checked="" type="radio"/> <input type="radio"/>
White / Plywood / Black	<input type="radio"/> <input checked="" type="radio"/> <input checked="" type="radio"/>
Black Linoleum / Plywood / White	<input checked="" type="radio"/> <input checked="" type="radio"/> <input type="radio"/>
Black Linoleum / Plywood / Black	<input checked="" type="radio"/> <input checked="" type="radio"/> <input checked="" type="radio"/>
Lacquered Oak Veneer / Plywood / White	<input checked="" type="radio"/> <input checked="" type="radio"/> <input type="radio"/>
Lacquered Oak Veneer / Plywood / Black	<input checked="" type="radio"/> <input checked="" type="radio"/> <input checked="" type="radio"/>

Dimensions

Ready-To-Ship Dimensions

Height 95 cm / 37.5"
190 x 50 cm / 74.75 x 19.75"
190 x 85 cm / 74.75 x 33.5"

Height 105 cm / 41.25"

190 x 50 cm / 74.75 x 19.75"
190 x 85 cm / 74.75 x 33.5"



Configurable

Base High Table w. Castors

Materials

Frame and legs from steel and extruded aluminum with powder coating, with matching castors. Tabletops with a laminate surface (HPL) with either ABS edges or plywood edges. Tabletops with a black linoleum surface or oak veneer surface with plywood edges in water-based lacquer. For Oak versions slight color variation can occur.

Certificates & Warranty

Strength & Stability: EN 15372 - L3, BIFMA X5.5*

*Not valid for L300 cm and L440 cm variants.

Eco Labels & Safety: VOC BIFMA X7.1*.

*Valid for Veneer variants

Warranty: 10 years. 5 years on L300 cm and L440 cm variants.

Options

Cable Management kit. A selection of finishes and non-standard sizes are made-to-order. Minimum - maximum length for made-to-order variants: 70 - 440 cm / 27.6" - 173.2". Minimum - maximum width for made-to-order variants: 50 - 120 cm / 19.7" - 47.2".

Color Options & Codes

Tabletop: Oak Veneer, White laminate (RAL 9016), White Nanolaminat (RAL), Black linoleum (RAL 9005), Black laminate (RAL 9005), Black Nanolaminat (RAL).

Frame/Legs: White (RAL 9016), Black (RAL 9005).



Configurable

Base Round Table

Materials

Frame and legs from extruded aluminum with powder coating. Tabletops with a laminate surface (HPL) with either ABS edges or plywood edges. Tabletops with a black linoleum surface or oak veneer surface with plywood edges in water-based lacquer. For Oak versions slight color variation can occur.

Certificates & Warranty

Strength & Stability: EN 15372 - L3, BIFMA X5.5.

Eco Labels & Safety: VOC BIFMA X7.1*.

*Valid for Veneer variants

Warranty: 10 years

Color Options & Codes

Tabletop: Oak Veneer, White laminate (RAL 9016), White Nanolaminat (RAL), Black linoleum (RAL 9005), Black laminate (RAL 9005), Black Nanolaminat (RAL). **Frame/Legs:** White (RAL 9016), Black (RAL 9005).

Ready-To-Ship Options

Tabletop/Edge/Frame

White / Plywood / White

White / Plywood / Black

Black Linoleum / Plywood / White

Black Linoleum / Plywood / Black

Dimensions

Ready-To-Ship Dimensions

Ø 110 cm / 43.3"

Diameter: 110 cm / 43.3"

Height: 73 cm / 28.75"

Tabletop height: 1,5 cm / 0.5"



Configurable

Base Round Table w. Castors

Materials

Frame and legs from extruded aluminum with powder coating, with matching castors. Tabletops with a laminate surface (HPL) with either ABS edges or plywood edges. Tabletops with a black linoleum surface or oak veneer surface with plywood edges in water-based lacquer. For Oak versions slight color variation can occur.

Certificates & Warranty

Strength & Stability: EN 15372 - L3, BIFMA X5.5.

Eco Labels & Safety: VOC BIFMA X7.1*.

*Valid for Veneer variants

Warranty: 10 years

Options

Cable Management kit. A selection of finishes and non-standard sizes are made-to-order.

Color Options & Codes

Tabletop: Oak Veneer, White laminate (RAL 9016), White Nanolaminat (RAL), Black linoleum (RAL 9005), Black laminate (RAL 9005), Black Nanolaminat (RAL).

Frame/Legs: White (RAL 9016), Black (RAL 9005).



Cable Management Kit

— Base Table, Base High Table & 70/70 Table

A cable management solution that can be implemented into tables to keep all your cables in order. The kit consists of a cable pit for the tabletop, a wire basket for underneath, a cable guide and grips that can hold the table in place. The Cable Management Kit can be implemented in the Base Table, Base High Table and 70/70 Table for efficient office and work environments.

Materials

Cable Pit: Aluminum.

Cable Basket: Steel.

Cable Sock: Polyester.

Ready-To-Ship Options

Black

Aluminum

Dimensions

Cable Pit: 29,5 x 11,7 x 2,75 cm / 11.5 x 4.5 x 1"

Cable Basket: 50 x 15 x 7 cm / 19.75 x 6 x 2.75"

Cable Sock: 300 cm / 118"

Base Table



70 x 70 cm / 27.5 x 27.5"
L 70 cm / 27.5"



W 70 cm / 27.5"

H 73 cm / 28.75"



190 x 85 cm / 75 x 33.5"
L 190 cm / 75"



W 85 cm / 33.5"

H 73 cm / 28.75"

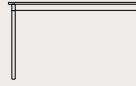


80 x 80 cm / 31.5 x 31.5"
L 80 cm / 31.5"

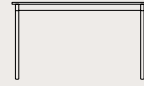


W 80 cm / 31.5"

H 73 cm / 28.75"



128 x 128 cm / 50.5 x 50.5"
L 128 cm / 50.5"



W 128 cm / 50.5"

H 73 cm / 28.75"



140 x 70 cm / 55 x 27.5"
L 140 cm / 55"



W 70 cm / 27.5"

H 73 cm / 28.75"

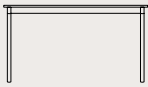


250 x 90 cm / 98.5 x 35.5"
L 250 cm / 98.5"



W 90 cm / 35.5"

H 73 cm / 28.75"



140 x 80 cm / 55 x 31.5"
L 140 cm / 55"

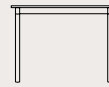


W 80 cm / 31.5"

H 73 cm / 28.75"



250 x 110 cm / 98.4 x 43.3"
L 250 cm / 98.5"



W 110 cm / 43.25"

H 73 cm / 28.75"

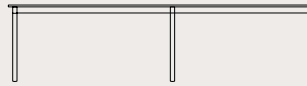


160 x 80 cm / 63 x 31.5"
L 160 cm / 63"

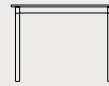


W 80 cm / 31.5"

H 73 cm / 28.75"



300 x 110 cm / 118 x 43.25"
L 300 cm / 118"



W 110 cm / 43.25"

H 73 cm / 28.75"

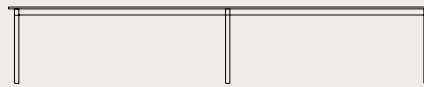


190 x 80 cm / 75 x 31.5"
L 190 cm / 75"

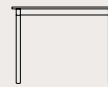


W 80 cm / 31.5"

H 73 cm / 28.75"



440 x 110 cm / 173.25 x 43.25"
L 440 cm / 173.25"

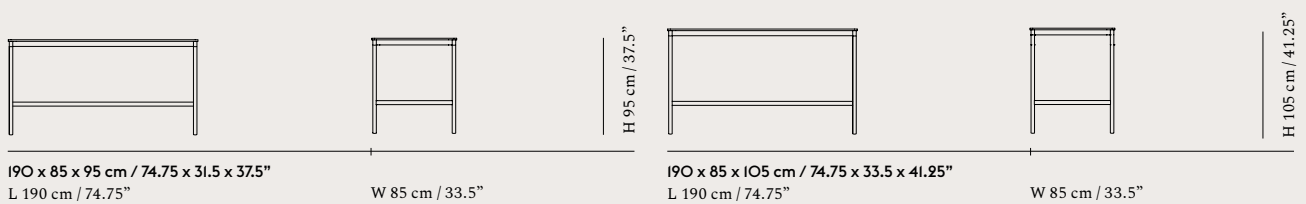
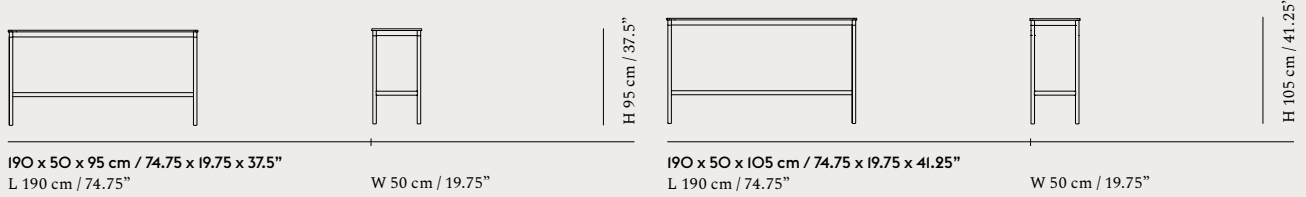
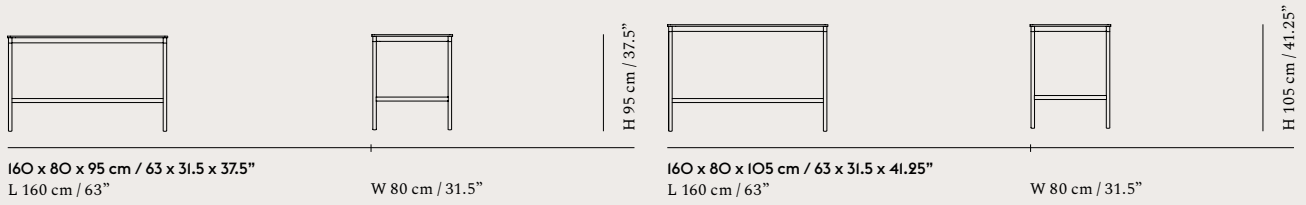
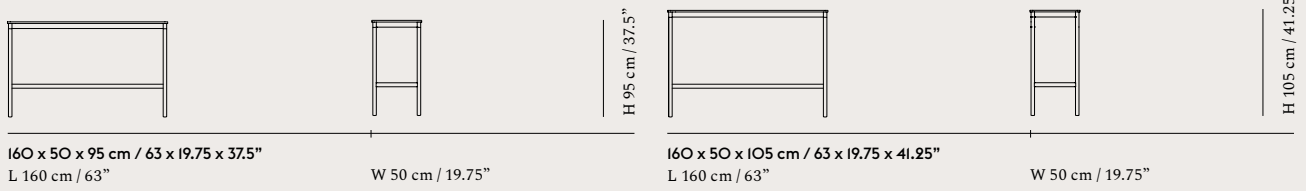


W 110 cm / 43.25"

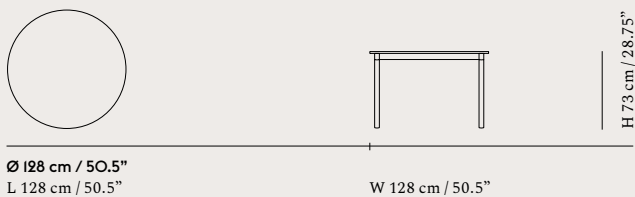
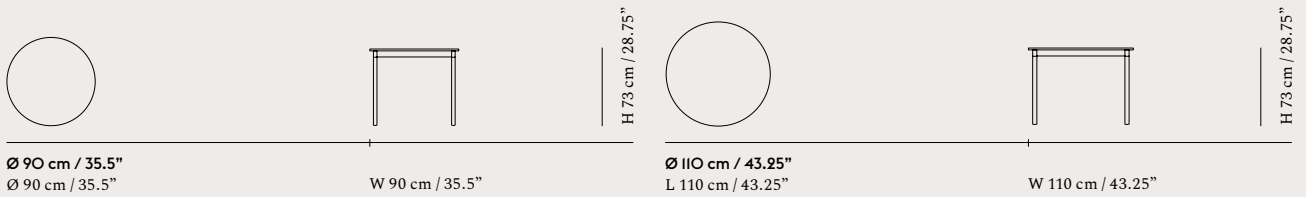
H 73 cm / 28.75"

The total height of Base Table with glides is aligned with the height of Base Table with castors.

Base High Table



Base Round Table



still café table

by Iskos-Berlin

182



Still Café Table
— 75 x 65 cm / 29.5 x 25.6"

Materials

Tabletop is made from MDF with either a linoleum or nanolaminate finish and lacquered edges. Nanolaminate tabletops in FSC™-certified wood. Base in die-cast aluminum. Mounting plate and tube are in powder coated steel. Adjustable feet in plastic.

Certificates & Warranty

Strength & Stability: EN 15372 - L3, BIFMA X5.5.
Eco Labels & Safety: VOC CDPH 01350 and BIFMA X7.1, FSC™.
Warranty: 10 years

Options

Power Outlet. Black linoleum tabletop.

Color Options & Codes

Tabletop: White Nanolaminate (Fenix 0029), Black Nanolaminate (Fenix 0720), Black Linoleum (Forbo 4166).
Frame: White (RAL 9010), Anthracite Black (RAL 7021).

Ready-To-Ship Options

Black Nanolaminate / Anthracite Black

White Nanolaminate / White

Black Nanolaminate / White

White Nanolaminate / Anthracite Black

Dimensions

Height 73 cm / 28.7"
75 x 65 cm / 29.5 x 25.6"
Tabletop height: 2,2 cm / 0.9"

Height 95 cm / 37.5"
75 x 65 cm / 29.5 x 25.6"
Tabletop height: 2,2 cm / 0.9"

Height 105 cm / 41.25"
75 x 65 cm / 29.5 x 25.6"
Tabletop height: 2,2 cm / 0.9"

Still Café Table
— Ø75 cm / 29.5" & Ø65 cm / 25.6"

Materials

Tabletop is made from MDF with either a linoleum or nanolaminate finish and lacquered edges. Nanolaminate tabletops in FSC™-certified wood. Base in die-cast aluminum. Mounting plate and tube are in powder coated steel. Adjustable feet in plastic.

Certificates & Warranty

Strength & Stability: EN 15372 - L3, BIFMA X5.5.
Eco Labels & Safety: VOC CDPH 01350 and BIFMA X7.1, FSC™.
Warranty: 10 years

Options

Power Outlet. Black Linoleum tabletop.

Color Options & Codes

Tabletop: White Nanolaminate (Fenix 0029), Black Nanolaminate (Fenix 0720), Black Linoleum (Forbo 4166).
Frame: White (RAL 9010), Anthracite Black (RAL 7021).

Ready-To-Ship Options

Black Nanolaminate / Anthracite Black

White Nanolaminate / White

Black Nanolaminate / White

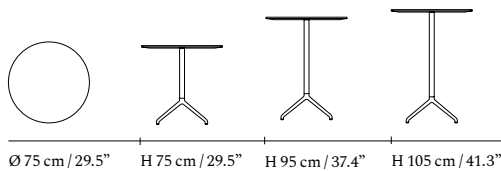
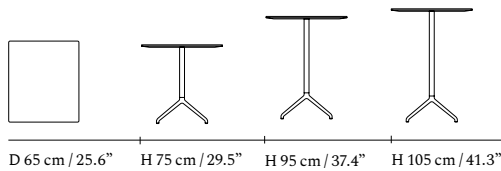
White Nanolaminate / Anthracite Black

Dimensions

Height 73 cm / 28.7"
Ø75 / 29.5"
Ø65 / 25.6"
Tabletop height: 2,2 cm / 0.9"

Height 95 cm / 37.5"
Ø75 / 29.5"
Ø65 / 25.6"
Tabletop height: 2,2 cm / 0.9"

Height 105 cm / 41.25"
Ø75 / 29.5"
Ø65 / 25.6"
Tabletop height: 2,2 cm / 0.9"



Still Café Table is also available with a tabletop in Ø65 cm / 25.6".

tables

soft table series

by Jens Fager

The Soft Table Series is incredibly versatile, offering a wide range of design possibilities and user-centric features. Both subtle yet characterful with its softened surfaces and understated functionalities, these tables come in a variety of sizes and finishes that will complement any atmosphere and space.



Soft Café Table

Materials

Tabletop in MDF with nanolaminate (Black), laminate (Beige Green) or linoleum (Grey) surface, in Solid Oak or in Solid Dark Oiled Oak. Laminate, Solid Oiled Oak and Solid Dark Oiled Oak tabletops are made using FSC™-certified wood. Base in powder coated, die-casted aluminum (made with at least 97 % recycled aluminum). Pre-mounted glides.

Certificates & Warranty

Strength & Stability: EN 15372 - L3.











Eco Label & Safety: FSC™

Warranty: 5 years

Color Options & Codes

Tabletop: Solid Oak, Solid Dark Oiled Oak, Black (NCS S9000-N), Beige Green (NCS S 2020-G80Y), Grey (NCS S 3502-Y). Base: Black (RAL 9005), Grey (RAL 7044), Beige Green (NCS S 2020-G80Y).

Ready-To-Ship Options

Black / Black	 
Grey / Grey	 
Beige Green / Beige Green	 
Solid Oak / Grey	 
Solid Dark Oiled Oak / Black	 

Dimensions

Ø 75 H 73 cm / Ø 27.6 H 28.7"

Diameter: 75 cm / 27.6"

Height: 73 cm / 28.7"

Ø 75 H 95 cm / Ø 27.6 H 37.4"

Diameter: 75 cm / 27.6"

Height: 95 cm / 37.4"

Ø 75 H 105 cm / Ø 27.6 H 41.3"

Diameter: 75 cm / 27.6"

Height: 105 cm / 41.3"

70x70 cm H 73 cm / 27.6x27.6 H 28.7"

Width: 70 cm / 27.6"

Depth: 70 cm / 27.6"

Height: 73 cm / 28.7"

70x70 cm H 95 cm / 27.6x27.6 H 37.4"

Width: 70 cm / 27.6"

Depth: 70 cm / 27.6"

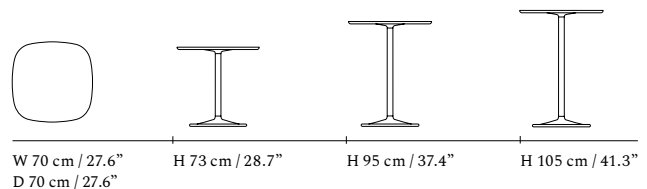
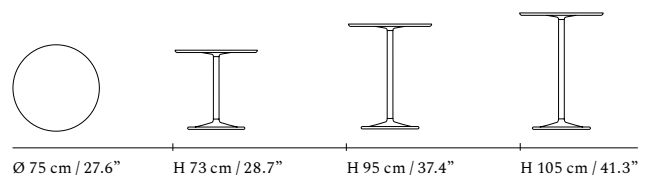
Height: 95 cm / 37.4"

70x70 cm H 105 cm / 27.6x27.6 H 41.3"

Width: 70 cm / 27.6"

Depth: 70 cm / 27.6"

Height: 105 cm / 41.3"



soft table series

by Jens Fager

184



Soft Table

Materials

Tabletop in MDF with nanolaminate (Black), laminate (Beige Green) or linoleum (Grey) surface, in Solid Oak or in Solid Dark Oiled Oak. Laminate, Solid Oiled Oak and Solid Dark Oiled Oak table-tops are made using FSC™-certified wood. Base in powder coated, die-casted aluminum (made with at least 97 % recycled aluminum). Pre-mounted glides.

Certificates & Warranty

Strength & Stability: EN 15372 - L3

Eco Label & Safety: FSC™











Warranty: 5 years

Color Options & Codes

Tabletop: Solid Oak, Solid Dark Oiled Oak, Black (NCS S9000-N), Beige Green (NCS S 2020-G80Y), Grey (NCS S 3502-Y).

Base: Black (RAL 9005), Grey (RAL 7044), Beige Green (NCS S 2020-G80Y).

Ready-To-Ship Options

Black / Black	 
Grey / Grey	 
Beige Green / Beige Green	 
Solid Oak / Grey	 
Solid Dark Oiled Oak / Black	 

Dimensions

Ø 95 H 73 cm / Ø 37.4 H 28.7"

Diameter: 95 cm / 37.4"
Height: 73 cm / 28.7"

Ø 95 H 95 cm / Ø 37.4 H 37.4"

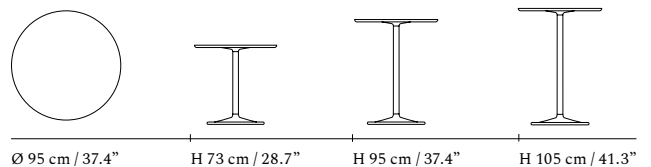
Diameter: 95 cm / 37.4"
Height: 95 cm / 37.4"

Ø 95 H 105 cm / Ø 37.4 H 41.3"

Diameter: 95 cm / 37.4"
Height: 105 cm / 41.3"



tables





Soft Coffee Table

Materials

Tabletop in MDF with nanolaminate (Black), laminate (Beige Green) or linoleum (Grey) surface, in Solid Oak or in Solid Dark Oiled Oak. Laminate, Solid Oiled Oak and Solid Dark Oiled Oak table-tops are made using FSC™-certified wood. Base in powder coated, die-casted aluminum (made with at least 97 % recycled aluminum). Pre-mounted glides.

Certificates & Warranty

Strength & Stability: EN 15372 - L3











Eco Label & Safety: FSC™

Warranty: 5 years

Color Options & Codes

Tabletop: Solid Oak, Solid Dark Oiled Oak, Black (NCS S9000-N), Beige Green (NCS S 2020-G80Y), Grey (NCS S 3502-Y). **Base:** Black (RAL 9005), Grey (RAL 7044), Beige Green (NCS S 2020-G80Y).

Ready-To-Ship Options

Black / Black	 
Grey / Grey	 
Beige Green / Beige Green	 
Solid Oak / Grey	 
Solid Dark Oiled Oak / Black	 

Dimensions

Ø 75 H 42 cm / 27.6" H 16.5"

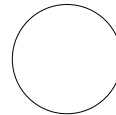
Diameter: 75 cm / 27.6"
Height: 42 cm / 16.5"

Ø 95 H 42 cm / 27.6" H 16.5"

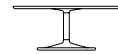
Diameter: 95 cm / 37.4"
Height: 42 cm / 16.5"

70x70 H 42 cm / 27.6x27.6 H 16.5"

Width: 70 cm / 27.6"
Depth: 70 cm / 27.6"
Height: 42 cm / 16.5"



Ø 95 cm / 37.4"



H 42 cm / 16.5"



Ø 75 cm / 27.6"



H 42 cm / 16.5"



W 70 cm / 27.6"
D 70 cm / 27.6"



H 42 cm / 16.5"

soft table series

by Jens Fager

186



Soft Side Table

Materials

Tabletop in MDF with nanolaminate (Black), laminate (Beige Green, Orange) or linoleum (Grey) surface, in Solid Oiled Oak or in Solid Smoked Oak. Laminate, Solid Oiled Oak and Solid Smoked Oak tabletops are made using FSC™-certified wood. Base in powder coated, die-casted aluminum (made with at least 97 % recycled aluminum). Pre-mounted glides.

Certificates & Warranty

Strength & Stability: EN 15372 - L3. BIFMA X5.5.

Eco Labels & Safety: VOC CDPH 01350 and BIFMA X7.1, FSC™, EU Ecolabel.













Warranty: 10 years

Color Options & Codes

Tabletop: Solid Oak, Solid Smoked Oak, Black (NCS S9000-N), Orange (NCS S1070-Y4OR), Beige Green (NCS S 2020-G80Y), Grey (NCS S 3502-Y).

Base: Black (RAL 9005), Grey (RAL 7044), Orange (RAL 2000), Beige Green (NCS S 2020-G80Y).

Ready-To-Ship Options

Black / Black	 
Grey / Grey	 
Orange / Orange	 
Beige Green / Beige Green	 
Solid Oak / Grey	 
Solid Smoked Oak / Black	 

Dimensions

Ø 41 H 40 cm / Ø 16.1" H 15.7"

Diameter: 41 cm / 16.1"
Height: 40 cm / 15.7"

Ø 41 H 48 cm / Ø 16.1" H 18.9"

Diameter: 41 cm / 16.1"
Height: 48 cm / 18.9"

Ø 48 H 40 cm / Ø 18.9" H 15.7"

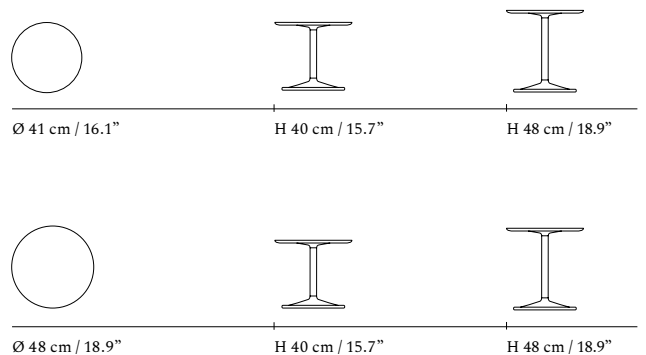
Diameter: 48 cm / 18.9"
Height: 40 cm / 15.7"

Ø 48 H 48 cm / Ø 18.9" H 18.9"

Diameter: 48 cm / 18.9"
Height: 48 cm / 18.9"



tables



couple coffee table

by Sylvain Willenz

Inspired by the traditional tile table, the Couple Coffee Table is a refined merging of materials — wood and ceramic stoneware. This sense of tactility is enhanced by the option of two different tabletop tiles; one with a plain and functional surface, the other with a more sculptural wavy feel. Choose between 36 prearranged variants spanning across various finishes and three sizes.



Couple Coffee Table

Materials

Tabletop tiles in ceramic stoneware treated with a stone sealer for extra stain protection. Tiles are placed loosely on top of the frame with rubber anti-slip pads securing the tiles in place. Frame in Solid Oak treated with either clear or dark oil, made using FSC™-certified wood. Premounted felt glides.

Certificates & Warranty

Strength & Stability: EN 15372 - L3, BIFMA X5.5
Eco Labels & Safety: VOC CDPH 01350 and BIFMA X7.1, FSC™.
Warranty: 10 years

Color Options & Codes

Tabletop: Pale Blue (NCS S 4005-B20G), Light Blue (NCS S 4010-B10G), Sand (NCS S 1505-Y30R), Taupe (NCS S 6005-Y20R)
Base: Oak, Dark Oiled Oak

Dimensions

40 x 84 cm / 15.7 x 33"	80 x 84 cm / 31.5 x 33"
Length: 40 cm / 15.7"	Length: 80 cm / 31.5"
Width: 84.5 cm / 33.2"	Width: 84.5 cm / 33.2"
Height: 40 cm / 15.7"	Height: 40 cm / 15.7"

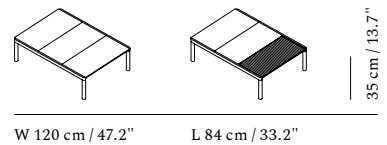
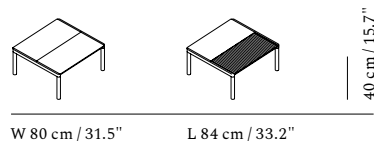
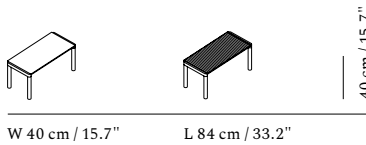
120 x 84 cm / 47.2 x 33.2"

Length: 120 cm / 47.2"
Width: 84.5 cm / 33.2"
Height: 35 cm / 13.7"

Ready-To-Ship Options

Sand / Oak	
Taupe / Oak	
Light Blue* / Oak	
Pale Blue* / Oak	
Sand / Dark Oiled Oak	
Taupe / Dark Oiled Oak	
Light Blue* / Dark Oiled Oak	
Pale Blue* / Dark Oiled Oak	

*Pale Blue is valid for tables with all plain tiles.
Light Blue is valid for tables that include a wavy tile.



workshop coffee table

by Cecilie Manz

Simple in its expression, the Workshop Coffee Table has a clean and refined look with its tabletop in oak veneer harmoniously carving itself into the frame of solid oak, echoing the understated details of traditional Scandinavian craftsmanship.



Workshop Coffee Table

Materials

Frame and legs in water-based lacquered solid oak. Table top with a lacquered oak veneer or linoleum finish. For Oak versions slight color variation can occur.

Certificates & Warranty

86 x 86 cm / 33.9 x 33.9"
Strength & Stability: EN 15372 - L3, BIFMA X5.5.
Eco Labels & Safety: VOC BIFMA X7.1
Warranty: 10 years

120 x 43 cm / 47.25 x 17"

Strength & Stability: EN 15372 - L3, EN 16139 - L2.
Eco Labels & Safety: VOC BIFMA X7.1
Warranty: 5 years

Color Options & Codes

Oak, Black (RAL 9005), Black Linoleum (Forbo 4023), Warm Grey Linoleum (Forbo 4176).

Ready-To-Ship Options

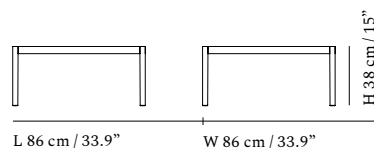
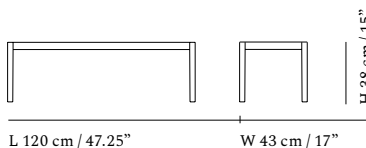
Oak / Oak	
Black / Black	
Warm Grey Linoleum / Oak	
Black Linoleum / Black	

Dimensions

86 x 86 cm / 33.9 x 33.9"
Length: 86 cm / 33.9"
Width: 86 cm / 33.9"
Height: 38 cm / 15"

120 x 43 cm / 47.25 x 17"

Length: 120 cm / 47.25"
Width: 43 cm / 17"
Height: 38 cm / 15"



around coffee table

by Thomas Bentzen

The Around Coffee Table has a unique expression with its frame in wood veneer that runs around the border of the tabletop. Place the Around Coffee Table on its own or in combination with various colors and sizes.



Around Coffee Table
— Small

Materials

Ash: Ash plywood and solid ash legs. Oak and Stained Dark Brown: Oak plywood and solid oak legs. For Oak and Stained Dark Brown versions slight color variation can occur. Colored tables: Ash plywood and solid ash legs. All with water-based lacquer. All versions are made using FSC™-certified wood.

Certificates & Warranty

Eco Labels & Safety: GreenTag Level C, VOC CDPH 01350 and BIFMA X7.1, FSC™.
Warranty: 5 years

Color Options & Codes

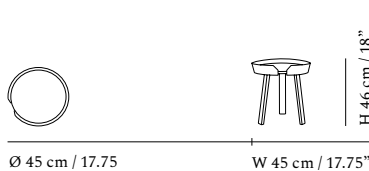
Oak, Ash, Stained Dark Brown, Anthracite (RAL 7016), Black (RAL 9017), Grey (NCS S 3000-N), White (RAL 9016), Dusty Green (NCS S 4010-G50Y), Light Blue (NCS 1515-B), Dark Green (RAL 6012).

Ready-To-Ship Options

Oak	
Ash	
Stained Dark Brown	
Black	
Grey	
Anthracite	
White	
Dusty Green	
Dark Green	
Light Blue	

Dimensions

Height: 46 cm / 18"
Diameter: 45 cm / 17.75"



Around Coffee Table
— Large

Materials

Ash: Ash plywood and solid ash legs. Oak and Stained Dark Brown: Oak plywood and solid oak legs. For Oak and Stained Dark Brown versions slight color variation can occur. Colored tables: Ash plywood and solid ash legs. All with water-based lacquer. All versions are made using FSC™-certified wood.

Certificates & Warranty

Strength & Stability: EN 15372-L3.
Eco Labels & Safety: GreenTag Level C, VOC CDPH 01350 and BIFMA X7.1, FSC™.
Warranty: 5 years

Color Options & Codes

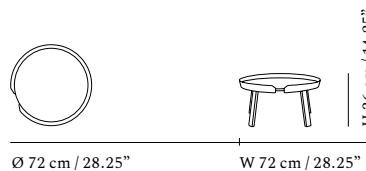
Oak, Ash, Stained Dark Brown, Anthracite (RAL 7016), Black (RAL 9017), Grey (NCS S 3000-N), White (RAL 9016), Dusty Green (NCS S 4010-G50Y), Dark Green (RAL 6012).

Ready-To-Ship Options

Oak	
Ash	
Stained Dark Brown	
Black	
Grey	
Anthracite	
White	
Dusty Green	
Dark Green	

Dimensions

Height: 36 cm / 14.25"
Diameter: 72 cm / 28.25"



Around Coffee Table
— Extra Large

Materials

Ash: Ash plywood and solid ash legs. Oak and Stained Dark Brown: Oak plywood and solid oak legs. For Oak and Stained Dark Brown versions slight color variation can occur. Colored tables: Ash plywood and solid ash legs. All with water-based lacquer. All versions are made using FSC™-certified wood.

Certificates & Warranty

Strength & Stability: EN 15372-L3.
Eco Labels & Safety: GreenTag Level C, VOC CDPH 01350 and BIFMA X7.1, FSC™.
Warranty: 5 years

Color Options & Codes

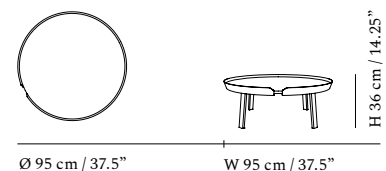
Oak, Ash, Stained Dark Brown, Anthracite (RAL 7016), Black (RAL 9017), Grey (NCS S 3000-N), White (RAL 9016), Dusty Green (NCS S 4010-G50Y).

Ready-To-Ship Options

Oak	
Ash	
Stained Dark Brown	
Black	
Grey	
Anthracite	
White	
Dusty Green	

Dimensions

Height: 36 cm / 14.25"
Diameter: 95 cm / 37.5"



airy coffee table

by Cecilie Manz

Airy Coffee Table has a light expression with its tabletop almost floating elegantly above the thinly welded frame. Airy is a multi-purpose family of tables that works on its own as well as when combined with different heights.



Airy Coffee Table
— Half Size

Airy Coffee Table
— Small, Medium & Large

Materials

Tabletop from plywood with a matt FENIX nanotech laminate finish. Frame from 8mm powder coated solid steel.

Materials

Tabletop from plywood with a matt FENIX nanotech laminate finish. Frame from 8mm powder coated solid steel.

Warranty

5 years

Warranty

5 years

Color Options & Codes

Black (Nero Ingo 0720/RAL 9011), Grey (Beige Arizona 0748/RAL 7039), Off-White (Bianco Male 0029/RAL 7044).

Color Options & Codes

Black (Nero Ingo 0720/RAL 9011), Grey (Beige Arizona 0748/RAL 7039), Off-White (Bianco Male 0029/RAL 7044).

Ready-To-Ship Options

Black	<input checked="" type="radio"/>
Grey	<input type="radio"/>
Off-White	<input type="radio"/>

Ready-To-Ship Options

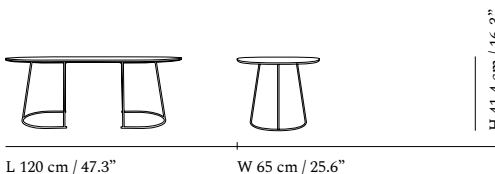
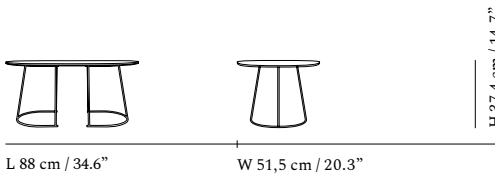
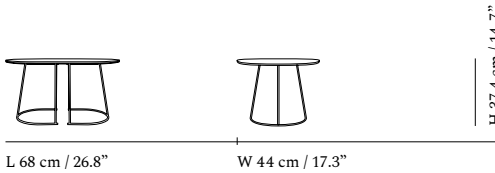
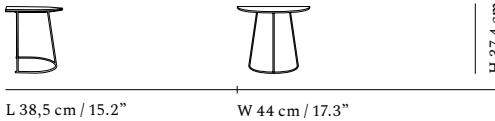
Black	<input checked="" type="radio"/>
Grey	<input type="radio"/>
Off-White	<input type="radio"/>

Dimensions

Height: 37,4 cm / 14.7"
Length: 38,5 cm / 15.2"
Width: 44 cm / 17.3"

Dimensions

Small
Height: 37,4 cm / 14.7"
Length: 68 cm / 26.8"
Width: 44 cm / 17.3"



relate side table

by Big-Game

An elegant side table with two planes, connected through a graphic leg for a modern expression. Pull the Relate Side Table up to a sofa to use as a hot desk during the workday or during meetings with a need for added laptop space.

190



Relate Side Table

Materials

Black, Off-White, Dark Green and Blue-Grey tabletop in linoleum finish. Oak Tabletop in laminate. Solid Oak and Smoked Oak in solid oak tabletop with an oil finish. Frame in powder coated steel.















Certificates & Warranty

Strength & Stability: EN 15372 - L3. **Eco Labels & Safety:** VOC CDPH 01350 and BIFMA X7.1. **Warranty:** 5 years

Color Options & Codes

Tabletop/base: Black (RAL 9017) / Black (RAL 9017), Off-White (RAL 1013) / Off-White (RAL 1013), Blue-Grey (Forbo Desktop 4179 Smokey Blue) / Blue-Grey (RAL 5008), Dark Green (Forbo Desktop 4174 Confier) / Dark Green (RAL 6012), Oak Laminate / Black (RAL 9017), Oak Laminate / Off-White (RAL 1013), Solid Oak / Off-White (RAL 1013), Solid Smoked Oak / Black (RAL 9011)

Ready-To-Ship Options

Black/ Black	 
Off-White / Off-White	 
Blue-Grey / Blue-Grey	 
Dark Green / Dark Green	 
Oak Laminate / Black	 
Oak Laminate / Off-White	 
Solid Smoked Oak / Black	 
Solid Oak / Off-White	 

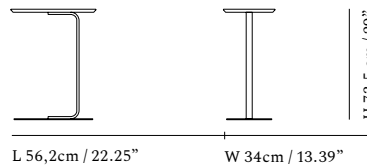
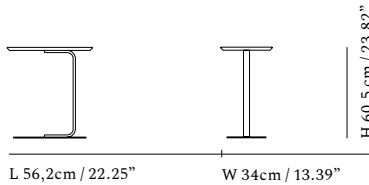
Dimensions

H 60,5 cm / 23.75"

Length: 56,2 cm / 22.25"
Width: 34 cm / 13.5"
Height: 60,5 cm / 23.75"

H 73,5 cm / 29"

Length: 56,2 cm / 22.25"
Width: 34 cm / 13.5"
Height: 73,5 cm / 29"



flow trolley

by Normal Studio

The Flow Trolley brings the concept of functional design into a modern context through its grooved trays in embossed metal for a contemporary expression, paired with the flexibility of its wheels that allows for it to be moved from one room into the other. The Flow Trolley adds modern storage to any space in the home, workplace or hospitality setting.

storage / tables



Flow Trolley

Materials

Trays and legs in powder coated steel. Wheels in powder coated steel and rubber.

Certificates & Warranty

Strength & Stability: EN 15372-L2. **Warranty:** 5 years

Color Options & Codes

Grey (RAL7044), Blue-Grey (RAL 5008).

Ready-To-Ship Options

Grey	
Blue-Grey	

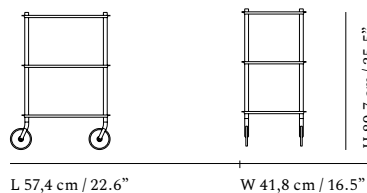
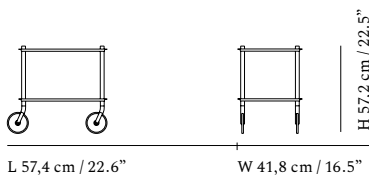
Dimensions

2 layer

Length: 57,4 cm / 22.6"
Height: 57,2 cm / 22.5"
Width: 41,8 cm / 16.5"
Distance between trays: 32,5 cm / 12.8"

3 layer

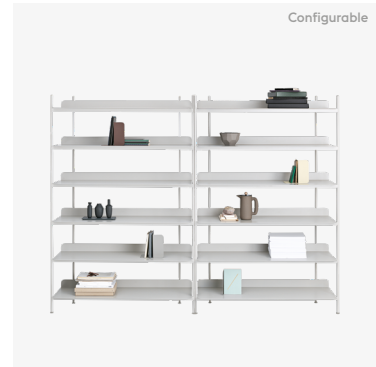
Length: 57,4 cm / 22.6"
Height: 89,7 cm / 35.5"
Width: 41,8 cm / 16.5"
Distance between trays: 32,5 cm / 12.8"



compile shelving system

by Cecilie Manz

With its simple and refined expression, the Compile Shelving System features clean lines in a solid construction. Choose from 8 predefined configurations or build your own Compile Shelving System by choosing from the different components.



Compile Shelving System

Materials

Shelves and dividers in powder coated steel. Top and bottom details in injection-molded plastic.

Certificates & Warranty

Strength & Stability: EN 16121-L1, EN 16121-L2*, BIFMA X5.9.

*All configurations mounted with wall brackets. Maximum height 225cm.

Warranty: 10 years

Specifications

Should always be mounted to a wall using wall brackets (included in the essentials pack). The system can hold up to 300 kg / 661 lb. The design can be built as tall as wanted, as long as it is mounted to the wall using wall brackets. Muuto recommends not building configurations higher than 2,25 m / 88.5".

Color Options & Codes

Grey (RAL 7044), Black (RAL 9011), White (RAL 9003)

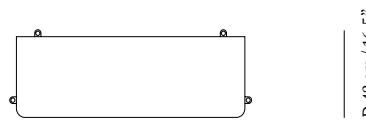
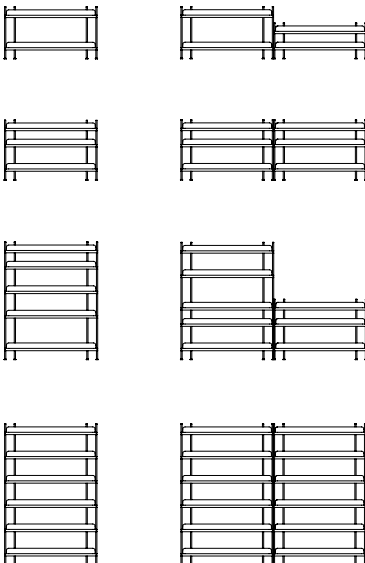
Ready-To-Ship Options

Grey	
Black	
White	

Dimensions

Shelf	
Height:	14 cm / 5.5"
Depth:	42 cm / 16.5"
Width:	120 cm / 47.2"
Storage Surface per Shelf	
Width:	115 cm / 45.3"
Depth:	40 cm / 15.7"
Divider Height	
Large:	39 cm / 15.5"
Medium:	28,5 cm / 11.2"
Small:	18 cm / 7.1"
Top/Bottom Cylinder Height	
Top cylinder:	11 cm / 4.3"
Feet:	11,6 cm / 4.6"

Inspiration



Shelf
W 120 cm / 47.2"



Divider — Small



Divider — Medium



Divider — Large

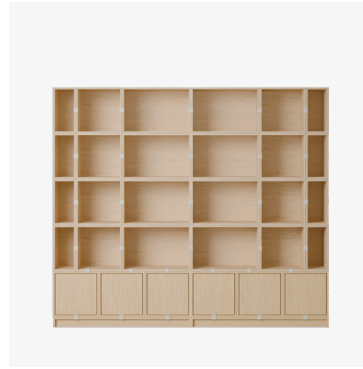


Essentials Pack

stacked storage system

by Julien De Smedt

192



Stacked Storage System

Materials

PU lacquered MDF or Oak veneered fiberboard. For Oak versions slight color variation can occur. The podium consists of a powder-coated steel frame and a wooden plate made from a PU lacquered MDF or oak veneered fiberboard. The Insert is made from bent powder-coated steel with rubber feet. Clips are powder-coated bent steel with rubber inserts.

Certificates & Warranty

Strength & Stability: EN 16121+A1 - L2*

*Valid for all pre-designed configurations

Warranty: 5 years

Options

Acoustic Panels for Stacked modules with backboard, top plate, shelves, clips.

Specifications

Max. weight of 25 kg / 55.1 lb per module or 12 kg / 26.5 lb if mounted on wall. Max. 6 modules on top of each other. Max. Height of 285 cm / 112.25". The modules should always be wall mounted or connected with 2 Stacked Clips per module - one on each side to ensure the overall stability. Only modules with backboard can be mounted on wall.

Color Options & Codes

All modules, wooden Shelf, Plinth & Podium top plate: Oak, White (RAL 9016), Grey (NCS S 2000-N), Brown Green (NCS S 6030-G90Y). Podium legs: Grey (RAL 7044). Insert: Grey (RAL 7044), Blue-Grey (RAL 5008). Clips: White (RAL 9016), Grey (NCS S 2000-N), Brown Green (NCS S 6030-G90Y).

Ready-To-Ship Options

Oak	
White	
Grey	
Brown Green	

Stacked Clips

Each Stacked module comes with two Clips in the same color as the module, while Oak comes with two Grey Clips. Extra Clips available in set of 2 in White, Grey and Brown Green.

storage



H 17,15 cm / 6.75"
D 35 cm / 13.78"

Podium w. Tube Base
W 130,8 cm / 51.5"



H 17,15 cm / 6.75"
D 35 cm / 13.78"

Podium w. Tube Base
W 43,6 cm / 17.17"



H 9,8 cm / 3.86"
D 35 cm / 13.78"

Plinth
W 130,8 cm / 51.5"



H 9,8 cm / 3.86"
D 35 cm / 13.78"

Plinth
W 43,6 cm / 17.17"



H 43,6 cm / 17.25"
D 35 cm / 13.78"

Small (Open or w. back)
W 21,8 cm / 8.58"



H 43,6 cm / 17.25"
D 35 cm / 13.78"

Medium (Open or w. back)
W 43,6 cm / 17.17"



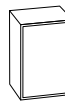
H 43,6 cm / 17.25"
D 35 cm / 13.78"

Large (Open or w. back)
W 65,4 cm / 25.75"



H 43,6 cm / 17.17"
D 35 cm / 13.78"

Medium w. Door
W 43,6 cm / 17.17"



H 65,4 cm / 25.75"
D 35 cm / 13.78"

Large w. Door
W 43,6 cm / 17.17"



H 1,85 cm / .73"
D 35 cm / 13.78"

Top Plate
L 131 cm / 51.57"



H 1,85 cm / .73"
D 35 cm / 13.78"

Top Plate
L 43,6 cm / 17.17"



H 1,05 cm / .41"
D 28,7 cm / 11.3"

Shelf
W 39,7 cm / 15.63"



H 20 cm / 7.87"
D 28,2 cm / 11.1"

Insert
W 39,6 cm / 15.59"



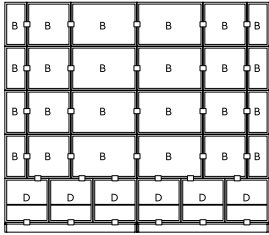
H 4,1 cm / 1.61"
D 2,39 cm / .94"

Clip
W 4,17 cm / 1.64"

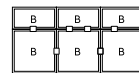
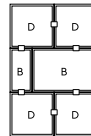
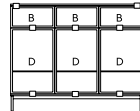
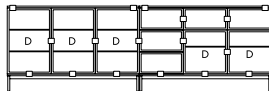
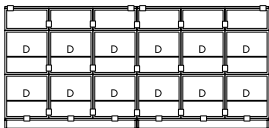
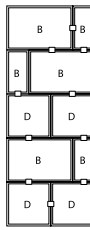
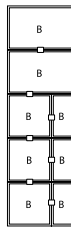
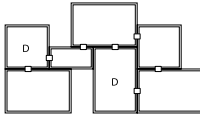
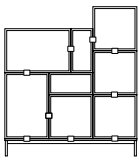
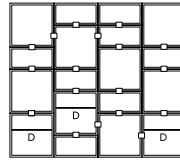
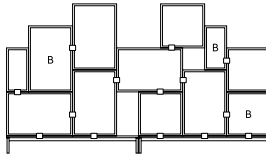
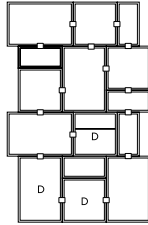
Choose from pre-designed configurations or design your own Stacked Storage System in the Stacked Product Planner.

B = module w. backboard
D = module w. door

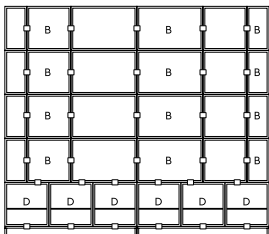
Shelves, indicated with lines on the drawings, can be positioned in two fixed positions inside modules w. door. Optional Inserts can be placed in open modules and modules w. backboard. Clips must be placed according to our assembly guidelines to suit your preferences. The illustrations of clips are for visual reference only. Please follow assembly rules and configuration guidelines when building your Stacked configuration.



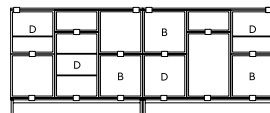
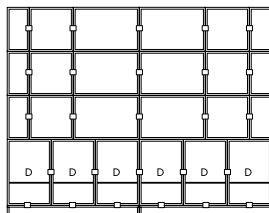
Bookcase



Sideboard



Office



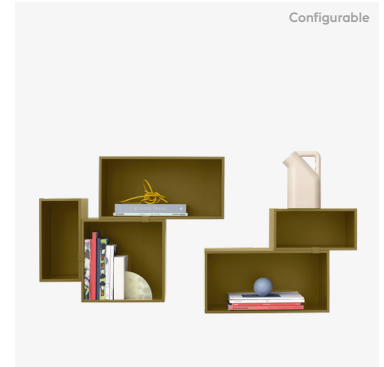
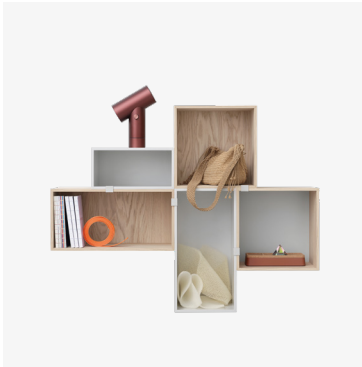
Bedside



mini stacked storage system

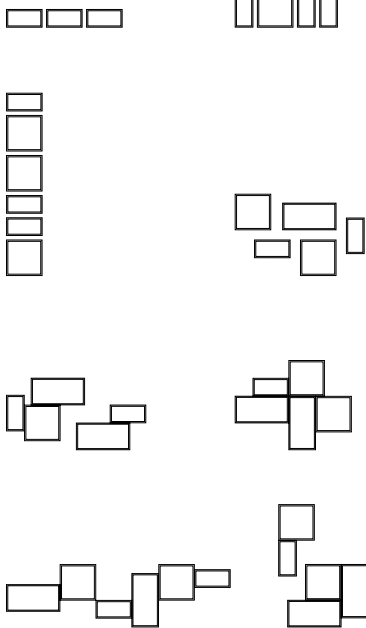
by Julien De Smedt

With modules in different shapes, sizes and colors, the Mini Stacked Storage System is a multi-functional, wall mounted shelving system, ideal for office interiors, lounge areas and hospitality settings. Choose from 8 pre-designed configurations or design your own with the Mini Stacked Product Planner.



Mini Stacked Storage System

Inspiration



Materials

Modules in PU lacquered MDF or Oak veneered fiberboard. Lacquered versions: Every side is cut out of MDF, glued together, and painted with three layers of PU lacquer. Oak versions: Every side is cut out of fiberboard with oak veneer and glued together. Clips are powder-coated bent steel with rubber inserts.

Warranty

5 years

Color Options & Codes

Oak, White (RAL 9016), Grey (NCS S 2000-N), Midnight Blue (NCS S 8010-R90B), Dusty Green (Pantone 5625 C), Brown Green (NCS S 6030-G90Y).

Ready-To-Ship Options

Oak	
White	
Grey	
Midnight Blue	
Brown Green	

Stacked Clips

Each Mini Stacked module comes with Clips in the same color as the module, while Oak comes with two Grey Clips. Extra Clips available in White, Grey and Brown Green.



Large
W 49,8 cm / 19.5" — D 26 cm / 10.25"

H 24,9 cm / 9.75"



Medium
W 33,2 cm / 13" — D 26 cm / 10.25"

H 33,2 cm / 13"



Small
W 33,2 cm / 13" — D 26 cm / 10.25"

H 16,6 cm / 6.5"



Clip
W 2,5 cm / 1" — D 1,6 cm / 0.5"

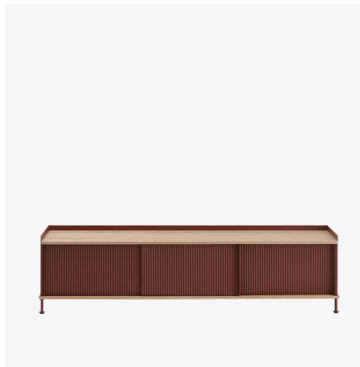
H 2,5 cm / 1"



enfold sideboard

by Thomas Bentzen

The Enfold Sideboard combines industrial materiality with residential references for a new perspective on modern storage. The flexible design is available in four sizes, which all have adjustable shelves and discreet cable outlets. This offers the opportunity to find just the right fit for your space, function and needs.



Enfold Sideboard

Materials

Body, shelves and sliding doors in powder-coated bent steel. Top and base in solid oak treated with a clear oil (size 186 x 45 H:48 cm and 148 x 45 H:85 cm as well as all sizes in Oak / Deep Red) or matte clear lacquer (for other variants). Adjustable feet.

Certificates & Warranty

Strength & Stability: EN 16121-L1, EN 16121-L2, BIFMA X5.9. **Eco Labels & Safety:** FSC™.

Warranty: 10 years

*Valid for size 186 x 45 H:48 cm and 148 x 45 H:85 cm as well as all sizes in Oak / Deep Red.

Options

Extra shelves

Color Options & Codes

Top: Oak, Grey (RAL 7044), Dusty Green (RAL 7033), Black (RAL 9005), Deep Red (RAL 8015)

Frame: Grey (RAL 7044), Dusty Green (RAL 7033), Anthracite Black (RAL 7021), Deep Red (RAL 8015)

Ready-To-Ship Options

Top / Frame

Oak / Grey	
Oak / Dusty Green	
Oak / Deep Red	
Oak / Anthracite Black	
Black / Anthracite Black	

Dimensions

100 x 45 H: 85 cm / 39 x 17.7 H: 33.2"

Height: 84,5 cm / 33.2"

Width: 99,5 cm / 39"

Depth: 45 cm / 17.7"

124 x 45 H: 63 cm / 49 x 17.7 H: 24.6"

Height: 62,5 cm / 24.6"

Width: 124,5 cm / 49"

Depth: 45 cm / 17.7"

186 x 45 H: 48 cm / 73 x 17.7 H: 18.9"

Height: 48 cm / 18.9"

Width: 186 cm / 73.2"

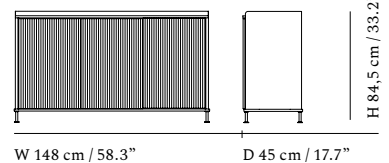
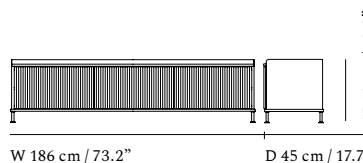
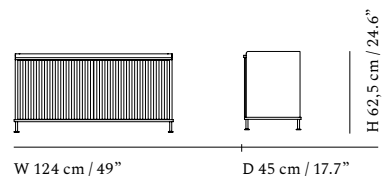
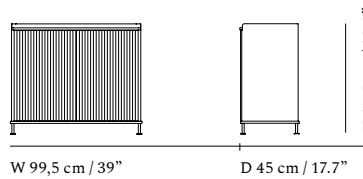
Depth: 45 cm / 17.7"

148 x 45 H: 85 cm / 58 x 17.7 H: 33.2"

Height: 84,5 cm / 33.2"

Width: 148 cm / 58.3"

Depth: 45 cm / 17.7"



out—

door



furniture⁹¹
lighting²⁰³
accessories²²⁴

linear steel series

by Thomas Bentzen

The Linear Steel Series brings new perspectives to modern outdoor furniture through its straight lines alongside the folded edges, half-circular intersecting legs and small spacing for easy removal of water. Kept visually clean for long-lasting aesthetics, the Linear Steel Series finds its distinct character through subtle detailing and a simple expression. The Chairs, Bar & Counter Stool Stack up to 5 on the floor. The Lounge Chair stack up to 4 on the floor.



Linear Steel Armchair

Materials

Galvanized steel with a weather-resistant deep matt, UV-resistant powder coated finish, making the chair suitable for outdoor use. Plastic glides.

Warranty

5 years

Options

Seat pads

Color Options & Codes

Anthracite Black (RAL 7021), Dark Green (RAL 6012), Burnt Orange (RAL 8001), Grey (RAL 7044), Pale Blue (NCS 4020-B).

Ready-To-Ship Options

Anthracite Black	
Grey	
Dark Green	
Burnt Orange	
Pale Blue	

Dimensions

Height:	85,1 cm / 33.5"
Width:	55,4 cm / 21.8"
Depth:	54 cm / 21.3"
Seat height:	46 cm / 18.1"
Armrest height:	65,8 cm / 25.9"



Linear Steel Side Chair

Materials

Galvanized steel with a weather-resistant deep matt, UV-resistant powder coated finish, making the chair suitable for outdoor use. Plastic glides.

Certificates & Warranty

Strength & Stability: EN 16139 - L1, EN 1022, EN 581-1, EN 581-2.

Warranty: 5 years

Options

Seat pads

Color Options & Codes

Anthracite Black (RAL 7021), Dark Green (RAL 6012), Burnt Orange (RAL 8001), Grey (RAL 7044), Pale Blue (NCS 4020-B).

Ready-To-Ship Options

Anthracite Black	
Grey	
Dark Green	
Burnt Orange	
Pale Blue	

Dimensions

Height:	85,1 cm / 33.5"
Width:	49,6 cm / 19.5"
Depth:	54 cm / 21.3"
Seat height:	46 cm / 18.1"



Linear Steel Bar & Counter Stool

Materials

Galvanized steel with a weather-resistant deep matt, UV-resistant powder coated finish, making the chair suitable for outdoor use. Plastic glides.

Certificates & Warranty

Strength & Stability: EN 581-1, EN 581-2.

Warranty: 5 years

Options

Seat pads

Color Options & Codes

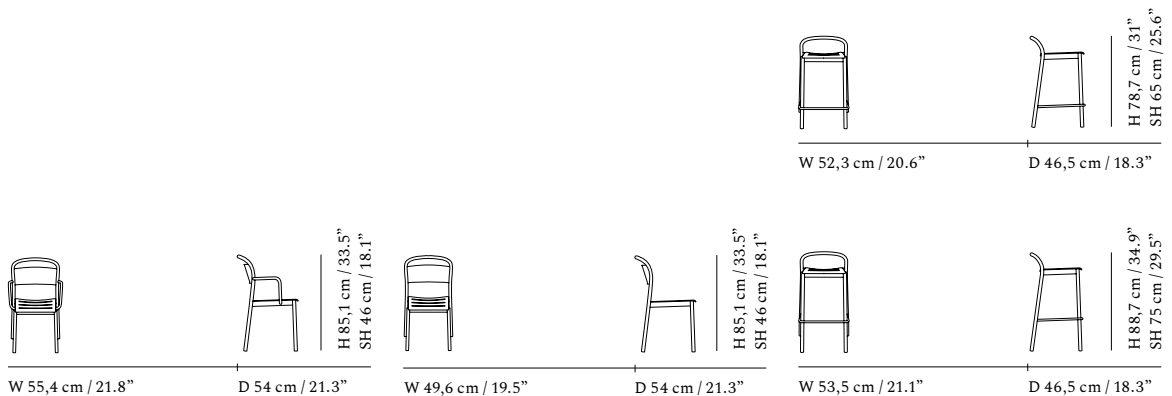
Anthracite Black (RAL 7021), Dark Green (RAL 6012), Burnt Orange (RAL 8001), Grey (RAL 7044), Pale Blue (NCS 4020-B).

Ready-To-Ship Options

Anthracite Black	
Grey	
Dark Green	
Burnt Orange	
Pale Blue	

Dimensions

Linear Steel Bar Stool	Linear Steel Counter Stool
Height: 88,7 cm / 34.9"	Height: 78,7 cm / 31"
Width: 53,5 cm / 21.1"	Width: 52,3 cm / 20.6"
Depth: 46,5 cm / 18.3"	Depth: 46,5 cm / 18.3"
Seat height: 75 cm / 29.5"	Seat height: 65 cm / 25.6"



linear steel series

by Thomas Bentzen

198



Linear Steel Café Table

— 70 x 70 cm / 27.6 x 27.6"

Materials

Galvanized steel with a weather-resistant deep matt, UV-resistant powder coated finish, making the table suitable for outdoor use. Plastic glides.

Certificates & Warranty






Strength & Stability: EN 15372 - L3, EN 581-1, EN 581-3, BIFMA X5.5.

Warranty: 10 years

Color Options & Codes

Anthracite Black (RAL 7021), Dark Green (RAL 6012), Burnt Orange (RAL 8001), Grey (RAL 7044), Pale Blue (NCS 4020-B).

Ready-To-Ship Options

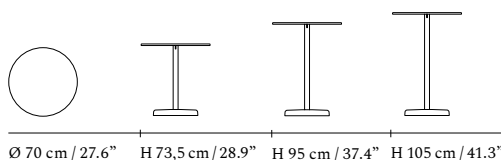
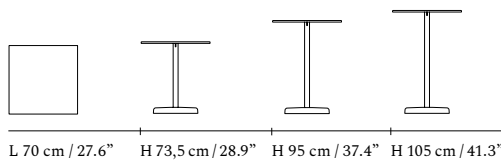
Anthracite Black	
Grey	
Dark Green	
Burnt Orange	
Pale Blue	

Dimensions

H 73,5 cm / 28.9"	
Length:	70 cm / 27.6"
Height:	73,5 cm / 28.9"
Width:	70 cm / 27.6"

H 95 cm / 37.4"	
Length:	70 cm / 27.6"
Height:	95 cm / 37.4"
Width:	70 cm / 27.6"

H 105 cm / 41.3"	
Length:	70 cm / 27.6"
Height:	105 cm / 41.3"
Width:	70 cm / 27.6"



Linear Steel Café Table

— Ø 70 cm / 27.6"

Materials

Galvanized steel with a weather-resistant deep matt, UV-resistant powder coated finish, making the table suitable for outdoor use. Plastic glides.

Certificates & Warranty






Strength & Stability: EN 15372 - L3, EN 581-1, EN 581-3, BIFMA X5.5.

Warranty: 10 years

Color Options & Codes

Anthracite Black (RAL 7021), Dark Green (RAL 6012), Burnt Orange (RAL 8001), Grey (RAL 7044), Pale Blue (NCS 4020-B).

Ready-To-Ship Options

Anthracite Black	
Grey	
Dark Green	
Burnt Orange	
Pale Blue	

Dimensions

H 73,5 cm / 28.9"	
Height:	73,5 cm / 28.9"
Diameter:	70 x 70 cm / 27.6 x 27.6"

H 95 cm / 37.4"	
Height:	95 cm / 37.4"
Diameter:	70 x 70 cm / 27.6 x 27.6"

H 105 cm / 41.3"	
Height:	105 cm / 41.3"
Diameter:	70 x 70 cm / 27.6 x 27.6"



Linear Steel Bench

Materials

Frame and seat are made from steel with a weather-resistant deep matt, UV-resistant powder coated finish. Seat is aluzinc while legs are galvanized treated, making them suitable for outdoor use. Plastic glides.

Certificates & Warranty

Strength & Stability: EN 16139 - L2, EN 1022, EN 581-1, EN 581-2, BIFMA X5.4.
Warranty: 10 years

Options

Ground Mounting Kit. Steel Screws. Glides. Seat pads.

Color Options & Codes

Anthracite Black (RAL 7021), Dark Green (RAL 6012), Burnt Orange (RAL 8001), Grey (RAL 7044), Pale Blue (NCS 4020-B).

Ready-To-Ship Options

Anthracite Black	
Grey	
Dark Green	
Burnt Orange	
Pale Blue	

Dimensions

110 x 34 cm / 43.3 x 13.4"

Length:	110 cm / 43.3"
Height:	45,5 cm / 17.9"
Width:	39 cm / 15.4"
Seat Width:	34 cm / 13.4"

170 x 34 cm / 67 x 13.4"

Length:	170 cm / 66.9"
Height:	45,5 cm / 17.9"
Width:	39 cm / 15.4"
Seat Width:	34 cm / 13.4"



Linear Steel Table

Materials

Frame and tabletop are made from steel with a weather-resistant deep matt, UV-resistant powder coated finish. Tabletop is aluzinc while legs are galvanized treated, making them suitable for outdoor use. Plastic glides.

Certificates & Warranty

Strength & Stability: EN 15372 - L3, EN 581-1, EN 581-3, BIFMA X5.5.
Warranty: 10 years

Options

Cover. Ground Mounting Kit. Screws. Glides.

Color Options & Codes

Anthracite Black (RAL 7021), Dark Green (RAL 6012), Burnt Orange (RAL 8001), Grey (RAL 7044), Pale Blue (NCS 4020-B).

Ready-To-Ship Options

Anthracite Black	
Grey	
Dark Green	
Burnt Orange	
Pale Blue	

Dimensions

140 x 75 cm / 55.1 x 29.5"

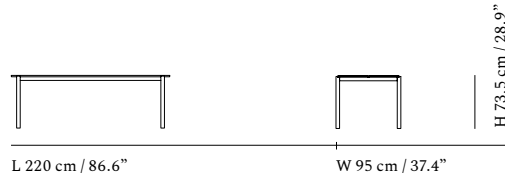
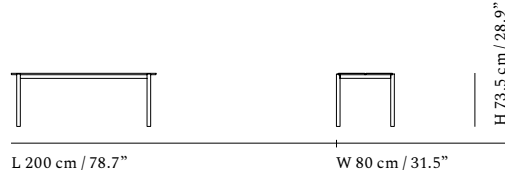
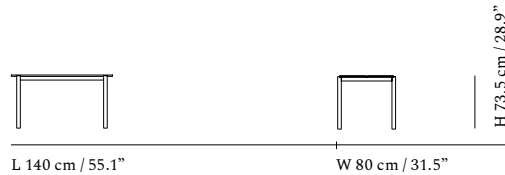
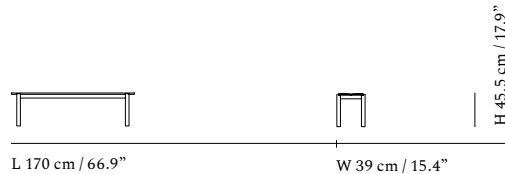
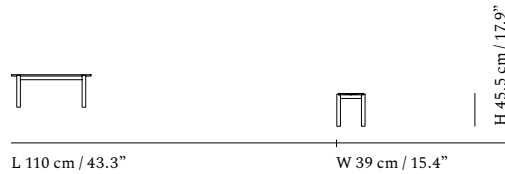
Length:	140 cm / 55.1"
Height:	73,5 cm / 28.9"
Width:	80 cm / 31.5"
Tabletop Width:	75 cm / 29.5"

200 x 75 cm / 78.8 x 29.5"

Length:	200 cm / 78.7"
Height:	73,5 cm / 28.9"
Width:	80 cm / 31.5"
Tabletop Width:	75 cm / 29.5"

220 x 90 cm / 86.6 x 35.5"

Length:	220cm / 86.6"
Height:	73,5 cm / 28.9"
Width:	95 cm / 37.4"
Tabletop Width:	90 cm / 35.4"



linear steel series

by Thomas Bentzen

200



Linear Steel Lounge Chair

Materials

Galvanized steel with a weather-resistant deep matt, UV-resistant powder-coated finish, making the chair suitable for outdoor use. Plastic glides.

Certificates & Warranty

Strength & Stability: EN 16139-L2, EN 581-1, EN 581-2, BIFMA X5.4

Warranty: 10 years






Options

Seat pads

Color Options & Codes

Anthracite Black (RAL 7021), Dark Green (RAL 6012), Burnt Orange (RAL 8001), Grey (RAL 7044), Pale Blue (NCS 4020-B).

Ready-To-Ship Options

Anthracite Black	
Grey	
Dark Green	
Burnt Orange	
Pale Blue	

Dimensions

Height:	75,4 cm / 29.7"
Width:	68,4 cm / 26.9"
Depth:	70,5 cm / 27.8"
Seat height:	38,8 cm / 15.3"
Armrest Height:	60,1 cm / 23.7"

Linear Steel Coffee Table

Materials

Galvanized steel with a weather-resistant deep matt, UV-resistant powder-coated finish, making the table suitable for outdoor use. Plastic glides.

Certificates & Warranty






Strength & Stability: EN 15372 - L3, EN 581-1, EN 581-3, BIFMA X5.5

Warranty: 10 years

Color Options & Codes

Anthracite Black (RAL 7021), Dark Green (RAL 6012), Burnt Orange (RAL 8001), Grey (RAL 7044), Pale Blue (NCS 4020-B).

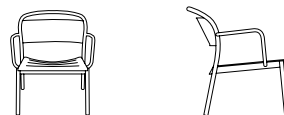
Ready-To-Ship Options

Anthracite Black	
Grey	
Dark Green	
Burnt Orange	
Pale Blue	

Dimensions

Ø 42 H 47 cm / 16.5 H 18.5"	
Diameter:	42 cm / 16.5"
Height:	47 cm / 18.5"
Ø 70 H 40 cm / 27.5 H 15.5"	
Diameter:	70 cm / 27.5"
Height:	40 cm / 15.5"

outdoor



W 68,4 cm / 26.9"

D 70,5 cm / 27.8"

H 75,4 cm / 29.7"
SH 38,8 cm / 15.3"



H 40 cm / 15.7"

Ø 70 cm / 27.6"



H 47 cm / 18.5"

Ø 42 cm / 16.5"

fiber outdoor arm & side chair

by Iskos-Berlin

Innovative shell material made of 100% recycled plastic. With each chair, a minimum of 3,2 kg of plastic waste is given new life. UV stabilizers are added to the shell's composite, protecting the color of the chair from the wear and tear of outside life. The Fiber Outdoor Armchair's friendly, embracing curves provide extensive comfort with a functional and durable design.



Fiber Outdoor Armchair

Materials

Made of 100% recycled plastic as well as UV stabilizers that keep color-fading at a minimum, protecting it from the impact of the sun. Tube base in galvanized steel with a weather-resistant deep matte powder coating. Plastic glides for outdoor use.





Certificates & Warranty

Strength & Stability: EN 1022, EN 16139 - L2, EN 581-1, EN 581-2, BIFMA X5.4. Eco Labels & Safety: VOC CDPH 01350 and BIFMA X7.1, EU Ecolabel. Warranty: 10 year

Color Options & Codes

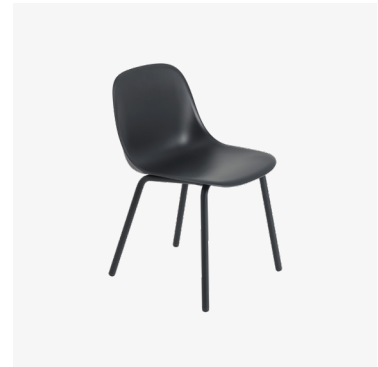
Anthracite Black (RAL 7021), Grey (7044), Dusty Green (RAL 7033), Brown Red (RAL 8017)

Ready-To-Ship

Anthracite Black	
Grey	
Dusty Green	
Brown Red	

Dimensions

Height:	77 cm / 30.3"
Width:	54.5 cm / 21.5"
Depth:	56 cm / 22"
Seat height:	46 cm / 18.1"
Armrest height:	68 cm / 26.8"



Fiber Outdoor Side Chair

Materials

Made of 100% recycled plastic as well as UV stabilizers that keep color-fading at a minimum, protecting it from the impact of the sun. Tube base in galvanized steel with a weather-resistant deep matte powder coating. Plastic glides for outdoor use.





Certificates & Warranty

Strength & Stability: EN 1022, EN 16139 - L2, EN 581-1, EN 581-2, BIFMA X5.4. Eco Labels & Safety: VOC CDPH 01350 and BIFMA X7.1, EU Ecolabel. Warranty: 10 year

Color Options & Codes

Anthracite Black (RAL 7021), Grey (7044), Dusty Green (RAL 7033), Brown Red (RAL 8017)

Ready-To-Ship

Anthracite Black	
Grey	
Dusty Green	
Brown Red	

Dimensions

Height:	77 cm / 30.3"
Width:	49.5 cm / 19.5"
Depth:	53 cm / 20.9"
Seat height:	46 cm / 18.1"



W 54,5cm / 21.5"



D 56 cm / 22.0"

H 77 cm / 30.3"
SH 46 cm / 18.1"



W 49,5 cm / 19.5"



D 53 cm / 20.9"

H 77 cm / 30.3"
SH 46 cm / 18.1"

70/70 outdoor table

by TAF Studio

The 70/70 Outdoor Table is designed with a simple expression, paired with subtle, understated details that reveal themselves upon closer inspection. Available with FSC™-certified Sapele Mahogany, a durable hardwood resistant to the wear and tear of being outdoors. With time, the wood will lose some of its reddish glow, giving way to a grey-tone patina. Treat with wood oil to enhance some of natural red of the wood.

70/70 Outdoor Table



Materials

Tabletop in FSC™-certified Sapele Mahogany. The base is made from aluminum with a weather-resistant, UV-resistant powder coated finish suitable for outdoor use. Plastic glides for outdoor use.

Certificates & Warranty

Strength & Stability: BIFMA X5.5, EN 581-1, EN 581-3, EN 15372 - L3. **Eco Labels & Safety:** FSC™
Warranty: 10 years

Options

Cover

Color Options & Codes

Tabletop: Sapele Mahogany
Base: Anthracite Black (RAL 7021), Grey (RAL 7044).

Ready-To-Ship Options

Sapele Mahogany / Anthracite Black

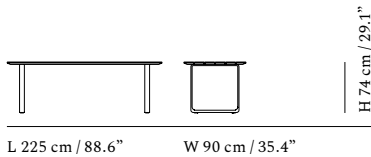


Sapele Mahogany / Grey



Dimensions

Length: 225 cm / 88.5"
Height: 73 cm / 28.7"
Width: 90 cm / 35.5"



202

outdoor lighting

Muuto's Outdoor Lighting collection merges Scandinavian design with modern innovation, offering durable and functional solutions for any outdoor space. These lamps illuminate with purpose, enhancing ambiance while integrating seamlessly with the natural environment.

outdoor



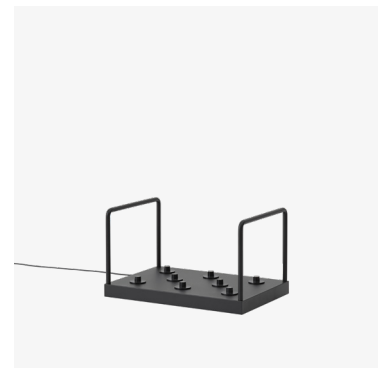
Piton Portable Lamp

As a USB rechargeable lamp, it offers the perfect alternative to traditional lamps – playfully referencing the archetypal flashlight. For more information, see page 222.



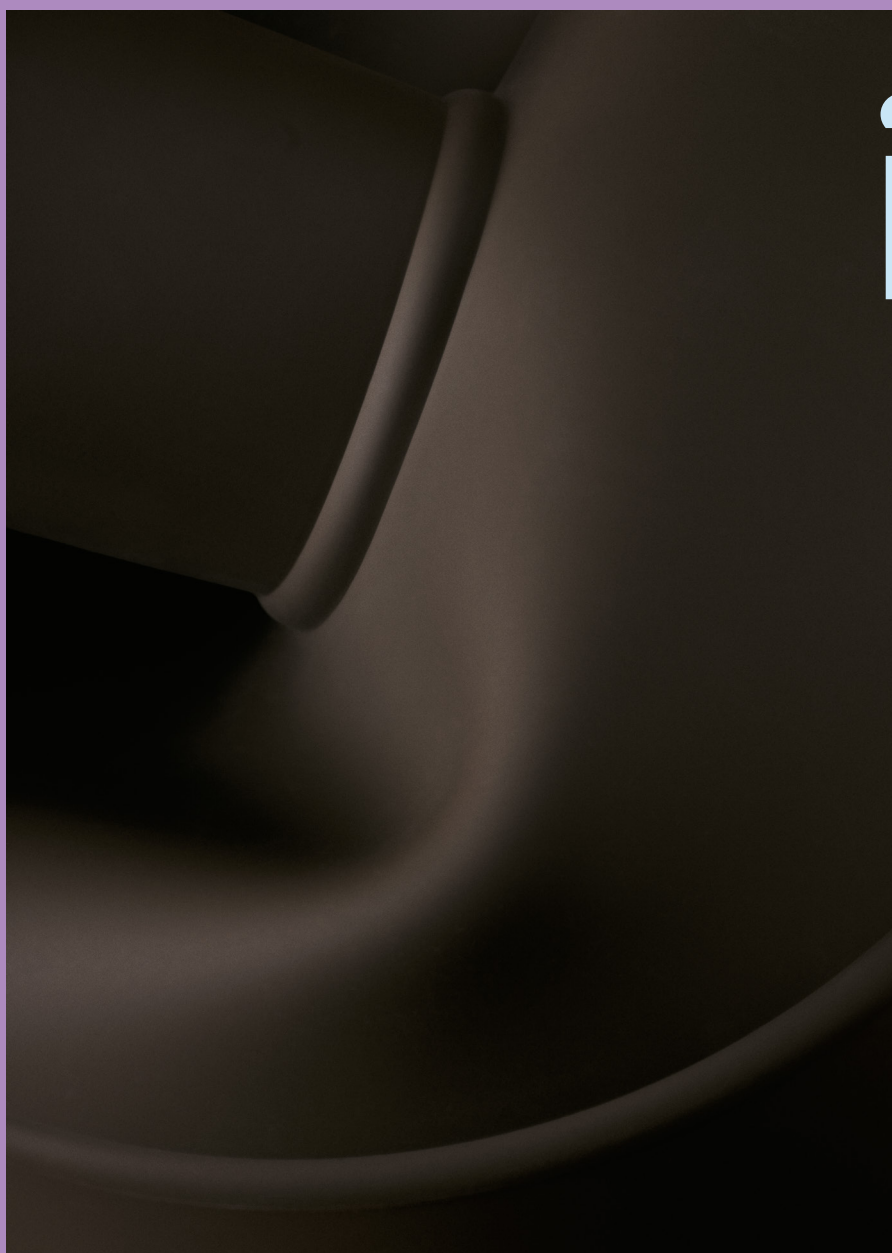
Ease Portable Lamp & Charging Station

Features dimmable, no-glare lighting with three settings for task or ambient light. Its charging tray can power eight lamps at once, with a stackable, mobile design for easy transport on a dolly or trolley, blending functionality and portability. For more information, see page 223.



light—

ing



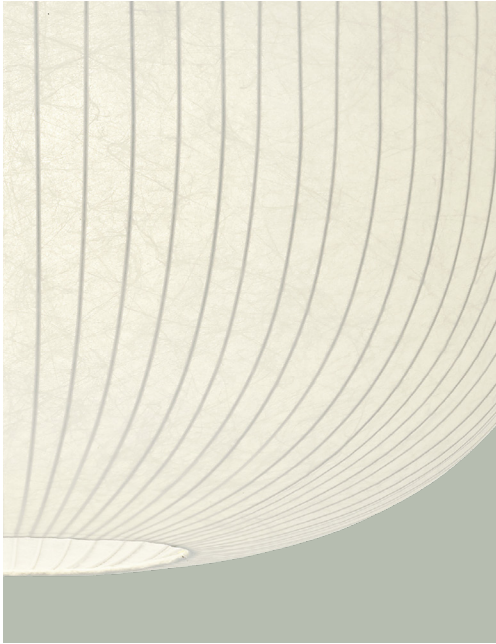
furniture⁹¹
outdoor¹⁹⁶
accessories²²⁴

strand lamp series

by Benjamin Hubert

The Strand Lamp Series is made in a sprayed cocoon material that consists of tiny strands for a complex, intriguing structure that gives it an almost cloud-like appearance. Filtering light through for a warm, comfortable glow, it brings a sense of comfort, harmony and a refined sensitivity to any room.

204




Strand Pendant Lamp

Materials

Cocoon layer with inner steel structure, PVC cord and PE covered steel wire.

Specifications

White ceiling cap included. Bulb not included.
IP20 

Max. Wattage (Eu Version):

Ø28 & Ø40: E27 socket. Max. 40W.

Ø45 Ø60 & Ø80: E27 socket. Max. 60W.

Warranty

5 years

Ready-To-Ship Options

White (NCS S0300-N)



Strand Table Lamp

Materials

Cocoon layer with inner steel structure, base in iron and aluminum, PVC cord with inline dimmer.

Specifications

Dimmable. Bulb not included.
IP20 

Max. Wattage (Eu Version):

E27 socket. Max. 13W LED.

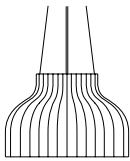
Warranty

5 years

Ready-To-Ship Options

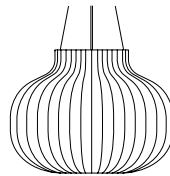
White (NCS S0300-N)

lighting



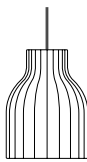
H 40,3 cm / 15,9"

Ø 60 cm / 23.5" — Cord length 500 cm / 196.9"



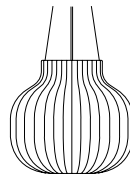
H 60,8 cm / 23,9"

Ø 80 cm / 31.5" — Cord length 500 cm / 196.9"



H 50,2 cm / 19,8"

Ø 40 cm / 16" — Cord length 300 cm / 118.1"



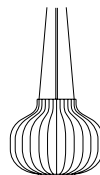
H 54,8 cm / 21,6"

Ø 60 cm / 23.5" — Cord length 500 cm / 196.9"



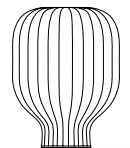
H 37,4 cm / 14,7"

Ø 28 cm / 11" — Cord length 300 cm / 118.1"



H 36,4 cm / 14,3"

Ø 45 cm / 17.7" — Cord length 500 cm / 196.9"



H 39 cm / 15,4"

Ø 29 cm / 11.4"

rime lamp series

by TAF Studio

The Rime Lamp Series brings a new perspective to the glass lamp through its semi-transparent glass that has been sandblasted for a refined expression. The design features a characteristic form, inspired by the shape of acorns, bringing a subtle detail to the home, restaurant or hotel room.



Rime Pendant Lamp

Materials

Mouthblown glass shade. Top-piece and pendant tube in casted, powder-coated aluminum. PVC cord.

Specifications

White ceiling cap included. Bulb not included.

IP20 CE 

Max. Wattage (Eu Version):

Ø45 & Ø37: 1x E26/E27 Max. 60W

Ø25: 1x E12/E14 Max. 40W

Ø12* & Ø18*: 1x G9 Max 25W

*EU version includes 3W frosted LED bulb

Energy classification: Ø18 & Ø12: G

Warranty

5 years

Options

Longer cord is available upon request.

Ready-To-Ship Options

White (RAL 9016)

Black (RAL 9011)

Grey (RAL 7044)

Orange (RAL 2000)

Deep Red (RAL 8015)


Rime Wall Lamp

Materials

Shade in mouthblown, sandblasted glass. Arm in pressure die-casted and powder-coated aluminum. Wall bracket in chrome-plated steel. PVC Cord.

Specifications

Dimmable LED bulb included. 1 x G9 3W / 2700K. 190 lm. Lumen maintenance of 20.000 hours.

IP20 CE 

Max. Wattage (Eu Version): G9 socket. Max. 25W.

Energy classification: G

Warranty

5 years

Options

When hardwiring, we recommend mounting onto a false wall, onto a headboard or using a trim plate.

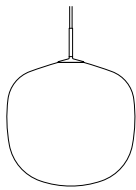
Ready-To-Ship Options

White (RAL 9016)

Black (RAL 9011)

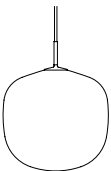
Grey (RAL 7044)

Orange (RAL 2000)



H 55,5 cm / 21.9"

Ø 45 cm / 17.7" — Cord length 400 cm / 157.5"



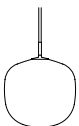
H 45,5 cm / 17.9"

Ø 37 cm / 14.6" — Cord length 400 cm / 157.5"



H 22 cm / 8.7"

Ø 18 cm / 7.1" — Cord length 400 cm / 157.5"



H 30 cm / 11.8"

Ø 25 cm / 9.8" — Cord length 400 cm / 157.5"



H 15 cm / 5.9"

Ø 12 cm / 4.7" — Cord length 400 cm / 157.5"



H 16,2 cm / 6.4"

L 23 cm / 9.1" — Cord length 250 cm / 98.4"

ambit lamp series

by TAF Studio

The Ambit Lamp Series brings a silently Scandinavian perspective to the archetypal light, paired with an understatedly modern expression. Taking its starting point in the simplicity of shapes, the Ambit Lamp Series is defined by its subtle details and refined lines.

206



Ambit Pendant Lamp

Materials

Hand-painted aluminum lampshade and PVC cord.

Specifications

White ceiling cap included.

Ø50, Ø40 & Ø25: Bulb not included. IP20 CE □ □ △ ⊕ ⊗ ⊘

Ø16,5: LED bulb included. 1 x GX53 5,5W / 2700K. 300-500 lm. Lumen maintenance of 30.000 hours. IP20 CE □ □ ⊕ ⊗ ⊘

Max. Wattage (Eu Version):

Ø50 & Ø25: E27 socket. Max. 60W. Self-ballasted LED bulb max. 11W.

Ø40: E27 socket. Max. 60W. Self-ballasted LED bulb max. 18W.

Ø16,5: GX53 socket. LED max. 12W.

Energy classification

Ø16,5: G

Warranty

5 years

Options

Longer cord is available upon request.

Ready-To-Ship Options

Dusty Green (RAL 140 60 10)



Black (RAL 7021)



Grey (RAL 7040)



White (RAL 9016)



Taupe (NCS S 6005-Y50R)



Light Blue (NCS 1515-R80B)



Rose* (RAL 040 80 10)

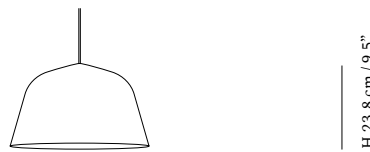


*Valid for Ø40 cm

lighting



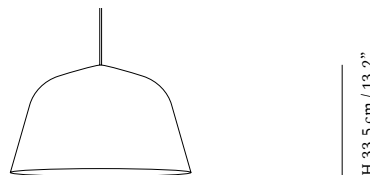
Ø 16,5 cm / 6.6" — Cord L 400 cm / 157.5"



Ø 40 cm / 15.75" — Cord L 400 cm / 157.5"



Ø 25 cm / 9.75" — Cord L 400 cm / 157.5"



Ø 55 cm / 21.7" — Cord L 400 cm / 157.5"



Ambit Rail Lamp

Materials

Cast and extruded aluminum. Shades of spun aluminum, PVC cord and steel wires.

Specifications

White ceiling cap included. Bulb not included.

IP20

Max. Wattage (Eu Version):

E14 socket. Max. 60W. Self-ballasted LED bulb max. 11W.

Warranty

5 years

Ready-To-Ship Options

Dusty Green (RAL 140 60 10)

Black (RAL 7021)

Grey (RAL 7040)

White (RAL 9016)

Taupe (NCS S 6005-Y50R)



Ambit Wall Lamp

Materials

Lampshade, arm fixture and wall bracket of pressure die-cast painted aluminum. PVC cord.

Specifications

Dimmable LED bulb included. 1 x GX53 5,5W/2700K. 330 lm. Lumen maintenance of 30.000 hours.

IP20

Max. Wattage (Eu Version):

GX53 socket. LED max. 12W.

Energy classification

G

Warranty

5 years

Options

When hardwiring, we recommend mounting onto a false wall, onto a headboard or using a trim plate.

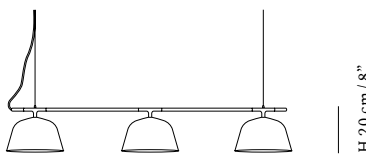
Ready-To-Ship Options

Black (RAL 7021)

Grey (RAL 7040)

White (RAL 9016)

Taupe (NCS S 6005-Y50R)



W 126 cm / 49.5"
Cord L 400 cm / 157.5" — Wire L 350 cm / 137.8"

H 20 cm / 8"



L 40,7 cm / 16"
Cord L 250 cm / 98.4"

H 19,5 cm / 7.7"

Ø 16,7 cm / 6.6"

top pendant lamp

by Big-Game

With its universal and simple design, Top Pendant is a contemporary reinterpretation of the archetypical cone-shaped pendant. Its top is a striking feature designed to neatly fit its compact LED light source. Manufactured in spun steel with a graphic rolled hem, it is a versatile lighting family that offers an array of opportunities in color, size and function.

208



Top Pendant Lamp

Materials

Spun steel shade with a high gloss wet paint finish. PVC cord. Socket in nylon. Ceiling cap in ABS.

Specifications

White ceiling cap included. Dimmable LED bulb included. 1 x GX53 9W / 2700K. 500 lm. Lumen maintenance of 25,000 hours.

IP20     


Warranty


5 years


Options


Longer cord is available upon request.

Ready-To-Ship Options

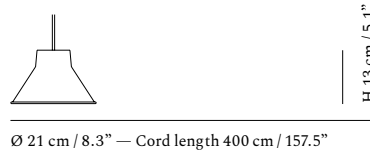
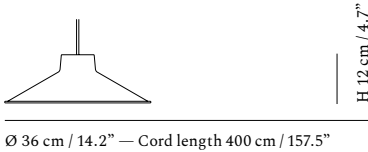
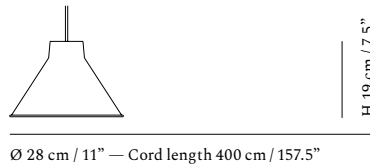
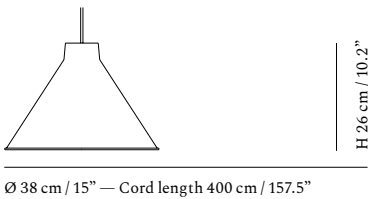
Sand (NCS S 2010-Y30R) 

Grey (RAL 7044) 

Deep Red (RAL 8015) 

Dark Green (NCS S 8505-G20Y) 

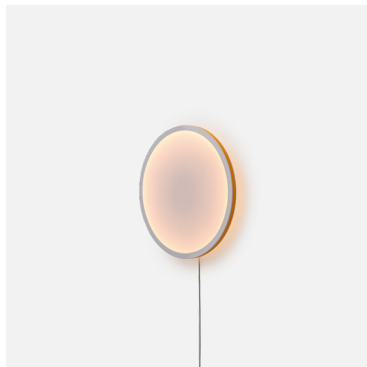
lighting



calm wall lamp

by Aleksej Iskos

Calm Wall Lamp offers a new perspective on lighting altogether, with a rare blend of atmospheric lighting and sculptural qualities. Its textile surface gently diffuses the light, forming a gradient from its edge to the central light source. The ability to adjust the lighting temperature allows the user to create calm, atmospheric light according to their own preferences and needs. A matte silicone band frames Calm Wall Lamp, lending a crisp edge to the softness of the design.



Calm Wall Lamp
— Wired w. Touch Dim

Materials

Extruded aluminum profile, steel mounting plates. Injection molded ABS cover, soft diffusing textile shades (front and back). Comes with a touch button and cable with a plug (no dimmer on the cable). Colored silicone band.

Specifications

Wired wall lamp. Integrated, dimmable (dim to warmer lighting), non-replaceable LED. 19W / 2200-3000K. 710 lm. Lumen maintenance of 60.000 hours.

IP20 CE

Energy specification

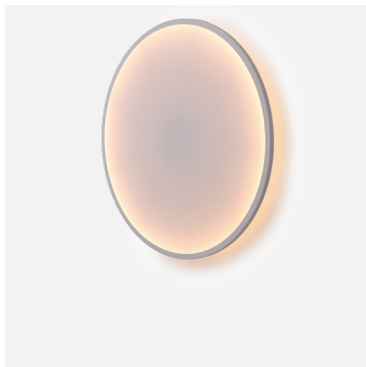
G

Warranty

5 years

Ready-To-Ship Options

- White / Black (RAL 9016)
- White / Grey (RAL 7044)
- White / Orange (RAL 2000)



Calm Wall Lamp
— Hard-wired

Materials

Extruded aluminum profile, steel mounting plates. Injection molded ABS cover, soft diffusing textile shades (front and back). Comes as hard-wired (wall dim). Colored silicone band.

Specifications

Hard-wired wall lamp. Integrated, dimmable (dim to warmer lighting), non-replaceable LED. Ø50: 19W / 2200-3000K. 710 lm. Lumen maintenance of 60.000 hours.

Ø68: 28W / 2200-3000K. 1000 lm. Lumen maintenance of 60.000 hours.

Ø90: 35W / 2200-3000K. 1400 lm. Lumen maintenance of 60.000 hours.

IP20 CE

Energy specification

G

Warranty

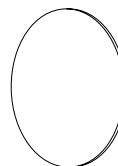
5 years

Options

Cord with inline dimmer and plug can be purchased separately.

Ready-To-Ship Options

- White / Black (RAL 9016)
- White / Grey (RAL 7044)
- White / Orange (RAL 2000)



Ø 90cm / 35,4" — D 7,25 cm / 2.85"



Ø 68 cm / 26.7" — D 7,25 cm / 2.85"



Ø 50 cm / 19.6" — D 7,25 cm / 2.85"



Ø 50 cm / 19.6" — D 7,25 cm / 2.85"

fine lamp series

by TAF Studio

The Fine Suspension and Wall/Ceiling Lamps blend industrial minimalism with elegance. Both available in three sizes, making them perfect as subtle enhancements or statement pieces. Fine Wall/Ceiling Lamp is also available in 6 pre-made configurations that can be positioned in numerous playful ways.

210



Fine Suspension Lamp

Materials

Body in pressure-die casted and extruded, powder coated aluminum. Diffuser in extruded opaque plastic. Lamp driver integrated in white plastic canopy.

Specifications

Integrated, dimmable, replaceable LED light designed for Right to Repair (light source can be replaced by an electrician only).

Max. Wattage (Eu Version):

60 cm: 13W / 2.700K. 620 lm.

Lumen maintenance of 30.000 hours.

90 cm: 17W / 2.700K. 950 lm.

Lumen maintenance of 30.000 hours.

120 cm: 21W / 2.700K. 1.200 lm.

Lumen maintenance of 30.000 hours.

IP20 CE

Energy specification

G

Warranty

5 years

Ready-To-Ship Options

Black (RAL 9011)



Grey (RAL 7044)



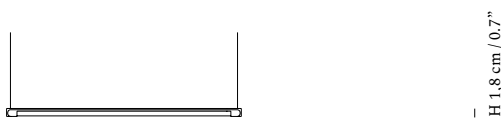
Deep Red (RAL 8015)



lighting



L 120cm / 47.2"
D 2,4 cm / 0.9"



L 90cm / 35.4"
D 2,4 cm / 0.9"



L 60 cm / 23.6"
D 2,4 cm / 0.9"



Fine Wall/Ceiling Lamp
— *Single Profiles*

Materials

Body in pressure-die casted and extruded, powder-coated aluminum. Diffuser in extruded opaque plastic. Single profiles come with an inline dimmer and plug.

Specifications

Dimmable, integrated, and non-user replaceable LED light designed for Right to Repair (only an electrician can replace the light source).

Max. Wattage (Eu Version):

- 60 cm: 13W / 2.700K. 620 lm.
- 90 cm: 17W / 2.700K. 950 lm.
- 120 cm: 21W / 2.700K. 1.200 lm.

Lumen maintenance of 30.000 hours.

IP20 CE

Energy specification

G

Warranty

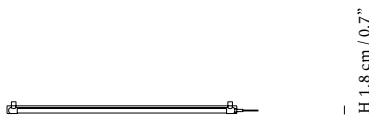
5 years

Ready-To-Ship Options

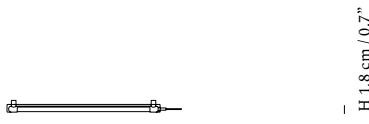
Black (RAL 9011)



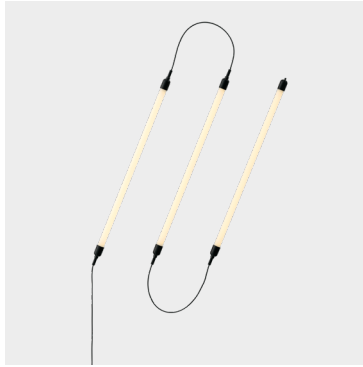
L 120cm / 47.2"
D 2,4 cm / 0,9"



L 90cm / 35.4"
D 2,4 cm / 0,9"



L 60 cm / 23.6"
D 2,4 cm / 0,9"



Fine Wall/Ceiling Lamp
— *Configurations*

Materials

Body in pressure-die casted and extruded, powder-coated aluminum. Diffuser in extruded opaque plastic. Configurations come with a wall/ceiling mounted driver integrated in white plastic driver box.

Specifications

Dimmable (configurations are dimmable when hardwired—no dimmer on cable), integrated, and non-user replaceable LED light designed for Right to Repair (only an electrician can replace the light source).

Max. Wattage (Eu Version):

- 60 cm: 13W / 2.700K. 620 lm.
- 90 cm: 17W / 2.700K. 950 lm.
- 120 cm: 21W / 2.700K. 1.200 lm.

Lumen maintenance of 30.000 hours.

IP20 CE

Energy specification

G

Warranty

5 years

Ready-To-Ship Options

Black (RAL 9011)

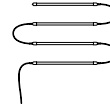


Inspiration

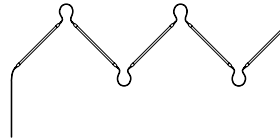
Choose from the 6 pre-made configurations that can be positioned in numerous playful ways.



Configuration 1
C1



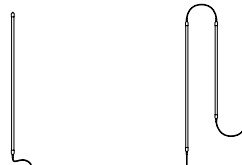
Configuration 2
A1



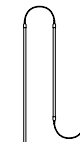
Configuration 3
D1



Configuration 4
B1



Configuration 5
B2



Configuration 6
A4

under the bell pendant lamp

by Iskos-Berlin

Created from a material that uses a recycled plastic felt, this eye-catching lamp creates a smaller space within the environment. The Under The Bell's shade improves the acoustics of a space by absorbing noise. The design is a great match for any space in need of acoustic enhancement and modern design in large spaces.

212







Under The Bell Pendant

Materials

Shade made using up to 41% fibers from recycled plastic bottles. PVC cord.

Specifications

White ceiling cap included. Bulb not included.
IP20 C    

Max. Wattage (Eu Version):
E27 socket. Max. 30W. LED max. 18W.

Warranty

5 years

Options

Longer cords are available upon request. Bulb can be purchased separately.

Ready-To-Ship Options

Grey (NSC S6500-N)	<input type="radio"/>
Black (RAL 9011)	<input checked="" type="radio"/>
Dark Green (NCS S7010-G10Y)	<input type="radio"/>
White Melange (RAL 7047)	<input type="radio"/>

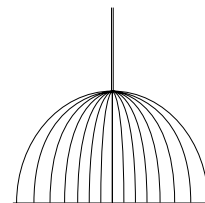


lighting



Ø 82 cm / 32.3" — Cord length 500 cm / 196.9"

H 31 cm / 12.2"



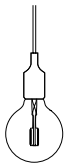
Ø 82 cm / 32.3" — Cord length 500 cm / 196.9"

H 46 cm / 18"

E27 pendant lamp

by Mattias Ståhlbom

A striking, naked bulb that plays with the subtle aesthetics and simplicity of industrial design. The E27 Pendant Lamp can be used as a single light source, in pairs, rows, or clusters to create a modern Scandinavian chandelier.



Ø 12,5 cm / 5" — Cord length 400 cm / 157.5"





H 23 cm / 9"

E27 Pendant Lamp

Materials

Silicone rubber, plastic socket and PVC cord.

Specifications

White ceiling cap included. Dimmable LED bulb included. 1 x G125 LED 2W / 2500K. >801 lm. Lumen maintenance of 25.000 hours. IP20 CE    

Max. Wattage (eu version): E27 socket. LED max. 6W.

Energy classification: G














Warranty

5 years

Options

Longer cords are available upon request.

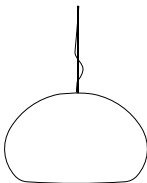
Ready-To-Ship Options

Black (Pantone 426)	
Light Grey (Pantone Cool Grey 4 C)	
White (RAL9016)	
Light Green (Pantone 5645 C)	
Olive (RAL 7002)	
Dark Green (RAL 6009)	
Light Blue (NCS S 1515-R80B)	
Pale Blue (Pantone 2137 C)	
Midnight Blue (RAL 5011)	
Dusty Lilac (RAL 4009)	
Deep Red (RAL 7015)	
Light Orange (RAL 2000)	
Beige-Green (Pantone 4535 C)	

fluid pendant lamp

by Claesson Koivisto Rune

The Fluid Pendant Lamp is inspired by a resting drop of water. The organic shape gives a soft appearance, enhanced by the frosted glass and diffused light. The lamp can be hung as a single feature over a table, or mixed in clusters of both dimensions to create a unique light setting for any lounge space or restaurant setting.



Ø 42 cm / 16.5" — Cord length 350 cm / 137.8"

H 27 cm / 10.5"

Fluid Pendant Lamp





Materials

White silk matt opal glass, lid in Nylon 66 with fiber glass.





Specifications

White ceiling cap included.

Large (Ø42): Bulb not included.

IP20 CE    

Small (Ø32): LED bulb included. 1 x G9 LED 3W / 2700K. 230 lm. Lumen maintenance of 25.000 hours. Not dimmable.

IP20 CE    

Max. Wattage (Eu Version):

Large (Ø42): E27 socket. Max 13 W. LED max. 60 W.

Small (Ø32): G9 socket. Max. 40W. LED max. 5W.

Warranty

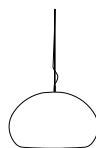
5 years

Options

Longer cords and wires are available upon request.

Ready-To-Ship Options

White	
-------	---



Ø 23 cm / 9" — Cord length 350 cm / 137.8"

H 14,3 cm / 5,5"

grain pendant lamp

by Jens Fager

The Grain Pendant Lamp is made from a bamboo fiber composite, lending the design an elegant, matte surface. The small-sized pendant works well on its own, in rows or in clusters.

Grain Pendant Lamp



Materials

Shade of bamboo fibers and polypropylene. Rubber cord.

Specifications

White ceiling cap included. LED bulb included. 1 x G9 3W /3000 K. 260 lm. Lumen maintenance of 20.000 hours.

IP20    

Max. Wattage (Eu Version): G9 socket. LED max. 5W.


Warranty

5 years


Options


Longer cords are available upon request.


Ready-To-Ship Options

Black (RAL Design 000 70 00)* 

Grey (RAL Classic 7004)* 

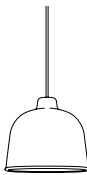
Dusty Green (RAL Design 160 50 15)* 

Dark Green (RAL 6012)* 

Blue-Grey (NCS S 6010-R90B)* 

Nature (RAL Design 070 40 30)* 

*Nearest match



H 18,5 cm / 7.3"

Ø 21 cm / 8.25" — Cord length 400 cm / 157.5"

214

unfold pendant lamp

by Form Us With Love

The soft, silicone rubber shade of Unfold makes for a unique and playful take on the timeless industrial lamp. With its modern expression and soft materiality in a wide variety of colors, the Unfold Pendant Lamp adds a vibrant touch to any space.

Unfold Pendant Lamp




Materials

Shade in silicone rubber with PVC cord. Diffuser in a clear, frosted opal acrylic material.

Specifications

White ceiling cap included. Bulb not included.

IP20    

Max. Wattage (eu version):

E27 socket. Max. 60W Type G. Energy saving bulb max. 20W. LED max. 18W.


Warranty


5 years


Options

Longer cords are available upon request.

Ready-To-Ship Options


White (RAL 9016) 


Black (Pantone 426) 


Dark Grey (Pantone Cool Grey 11 U) 


Light Grey (Pantone Cool Grey C) 


Green (Pantone 5625C) 


Olive (RAL 7002) 


Dark Brown (Pantone 7533 C) 

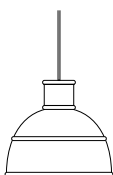
Mustard (RAL 1245C) 

Light Yellow (Pantone 607 C) 

Orange (Pantone 1655) 

Terracotta (Pantone 7607C) 

Beige-Rose (Pantone 7590 C) 



H 29,5 cm / 11.5"

Ø 32,5 cm / 12.8" — Cord length 350 cm / 137.8"

lighting

tip lamp series

by Jens Fager

The Tip Lamp Family is a simple, friendly lamp series with a characteristic architectural silhouette. Its molded aluminum gives the design a clean and precise look while complementing its distinct form. Offering both direct and ambient lighting with its dimmer function, the design is intended for use in any space—from offices over educational settings to hotel rooms.




Tip Wall Lamp

Materials

Powder coated aluminum. PVC cord. Backplate in injection-molded plastic. Wall bracket in chrome steel.

Specifications

Integrated, dimmable, non-replaceable LED bulb. 1 x 8W / 2700K, 3 steps. 220 lm. Lumen maintenance of 35.000 hours.

IP20    

Warranty

5 years

Options

Can be hardwired into the wall.

Ready-To-Ship Options

Black (RAL 9011)	<input checked="" type="radio"/>
White (RAL 9016)	<input type="radio"/>
Grey (RAL 7044)	<input type="radio"/>
Copper Brown (RAL 8004)	<input type="radio"/>
Light Green (NCS S 2020-G50Y)	<input type="radio"/>



Tip Table Lamp

Materials

Casted and extruded aluminum. PVC cord.

Specifications

Integrated, dimmable, non-replaceable LED bulb. 1 x 8W / 2700K, 3 steps. 200 lm. Lumen maintenance of 30.000 hours.

IP20    

Warranty

5 years

Ready-To-Ship Options

Black (RAL 9011)	<input checked="" type="radio"/>
White (RAL 9016)	<input type="radio"/>
Grey (RAL 7044)	<input type="radio"/>
Copper Brown (RAL 8004)	<input type="radio"/>
Light Green (NCS S 2020-G50Y)	<input type="radio"/>




Tip Floor Lamp

Materials

Pressure die casted aluminum. Powder coated. PVC cord.

Specifications

Integrated, dimmable, non-replaceable LED bulb. 10.9W / 2700K, 3 steps. 330 lm. Lumen maintenance of 35.000 hours.

IP20    

Energy classification

G

Warranty

5 years

Ready-To-Ship Options

Black (RAL 9011)	<input checked="" type="radio"/>
White (RAL 9016)	<input type="radio"/>
Grey (RAL 7044)	<input type="radio"/>



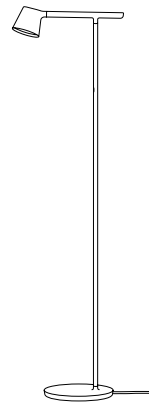
D 16 cm / 6.3" — Lamp head Ø 9,5 cm / 3.7"
Cord L 250 cm / 98.4"

H 9,5 cm / 3.7"



D 29,5 cm / 11.5" — Stand Ø 16 cm / 6.25"
Cord L 250 cm / 98.4"

H 40 cm / 15.75"



D 32 cm / 12.6" — Stand: Ø 20 cm / 7.9"
Cord L 250 cm / 98.4"

H 110,8 cm / 43.6"

post lamp series

by Earnest Studio

An innovative modular lighting design with an archetypal appearance, graphic character and forward-thinking functionalities. Position, turn and dim the lamp's lighting units according to individual needs.

216



Post Table Lamp

Materials

Base in powder coated steel. Lighting unit in powder coated magnesium with silicone cord and opal diffuser. Cable drops in ABS with magnet. Power supply with connector and PVC cord.

Specifications

Integrated, dimmable, non-replaceable LED bulb. 1 x 6,1W / 2700K. 330 lm. Lumen maintenance of 54.000 hours. IP20 c€

Energy classification

G

Warranty

5 years

Ready-To-Ship Options

Black (RAL 9011)	
Brown Green (NCS S 6030-G90Y)	



W 9,5 cm / 3.7"
Lighting unit Ø 9,5 cm / 3.7"

H 45,2 cm / 17.8"



Post Wall Lamp

Materials

Lighting unit in powder coated magnesium with silicone cord and opal diffuser. Wall mounting bracket in powder coated steel. Wall cable drops in ABS with magnet and repositionable adhesive tape. Power hub in wet painted ABS with PVC cord.

Specifications

Integrated, dimmable, non-replaceable LED bulb. 1 x 6,1W / 2700K. 330 lm. Lumen maintenance of 54.000 hours. IP20 c€

Max. Wattage (Eu Version)

Max. 7,4W (one lighting unit incl. powerhub)

Energy classification

G

Warranty

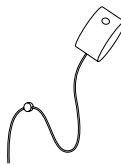
5 years

Options

Additional lighting units and wall cable drops available as spare parts. Up to three lighting units can be plugged to a power hub.

Ready-To-Ship Options

Black (RAL 9011)	
Brown Green (NCS S 6030-G90Y)	



Ø 9,5 cm / 3.7" — Power Hub cord L 250 cm / 98.4"

D 5,4 cm / 2.1"



Post Floor Lamp

Materials

Base in powder coated steel. Lighting unit in powder coated magnesium with silicone cord and opal diffuser. Cable drops in ABS with magnet. Power hub in wet painted ABS with PVC cord.

Specifications

Integrated, dimmable, non-replaceable LED bulb. 1 x 6,1W / 2700K. 330 lm. Lumen maintenance of 54.000 hours. IP20 c€

Max. Wattage (Eu Version)

Max. 7,4W (one lighting unit incl. powerhub)
Max. 14,3W (two lighting units incl. powerhub)

Energy classification

G

Warranty

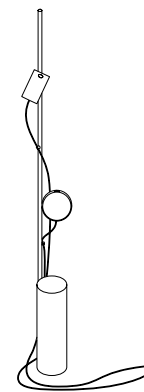
5 years

Options

Additional lighting units and magnet cable drops available as spare parts. Up to three lighting units can be plugged to a power hub.

Ready-To-Ship Options

Black (RAL 9011)	
Brown Green (NCS S 6030-G90Y)	



W 9,5 cm / 3.7" — Power Hub cord L 200 cm / 78.7"
Cord L 250 cm / 98.4"

H 136,2 cm / 53.6"

lighting

leaf lamp series

by Broberg & Ridderstråle

The Leaf Lamp Series has a friendly silhouette, inspired by the form of leaves on a tree. Alter the position of its shade and dim the light according to your given needs in a workplace, education setting or lounge area.







Leaf Table Lamp

Materials

Powder coated aluminum. Colored PVC cord.

Specifications

52 x Integrated, dimmable, non-replaceable LED bulb. 8W / 3000K, 3 steps. 370 lm. Lumen maintenance of 54.000 hours. IP20    

Energy classification

G

Warranty

5 years

Ready-To-Ship Options

Black (RAL 9011)	<input checked="" type="radio"/>
White (RAL 9016)	<input type="radio"/>
Grey (RAL 7040)	<input type="radio"/>
Dark Green (RAL 6012)	<input type="radio"/>
Copper Brown (RAL 8004)	<input type="radio"/>







Leaf Floor Lamp

Materials

Powder coated aluminum. Colored PVC cord.

Specifications

52 x Integrated, dimmable, non-replaceable LED bulb. 8W / 3000K, 3 steps. 370 lm. Lumen maintenance of 54.000 hours. IP20    

Energy classification

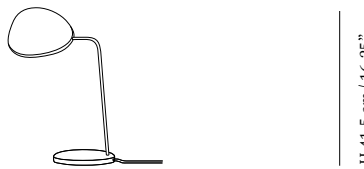
G

Warranty

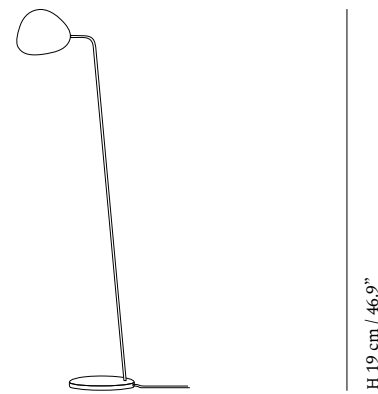
5 years

Ready-To-Ship Options

Black (RAL 9011)	<input checked="" type="radio"/>
White (RAL 9016)	<input type="radio"/>
Dark Green (RAL 6012)	<input type="radio"/>
Copper Brown (RAL 8004)	<input type="radio"/>



Lampshade 15,5 x 18,5 cm / 6 x 7.25"
Base Ø 18 cm / 7" — Cord L 180 cm / 70.9"



Lampshade 15,5 x 18,5 cm / 6 x 7.25"
Base Ø 22 cm / 8.75" — Cord L 250 cm / 98.4"

linear lamp series

by Thomas Bentzen

The Linear Lamp Series is designed to create smaller atmospheres within larger spaces. The design features elegant lines and subtle details alongside the inherent functionality of its dimmable light source, making for a modern, functional light for any space.

218




Linear Table Lamp

Materials

Lamphead in powder coated, pressure die-casted aluminum. Stem in powder coated steel. Polycarbonate diffuser and PVC cord.

Specifications

Integrated, dimmable, non-replaceable LED bulb. 6,25W / 3000K, 3 steps. 242 lm. Lumen maintenance of 48.000 hours. IP20 

The design features a built-in 18W USB-C plug for charging electronical devices.


Energy classification


G

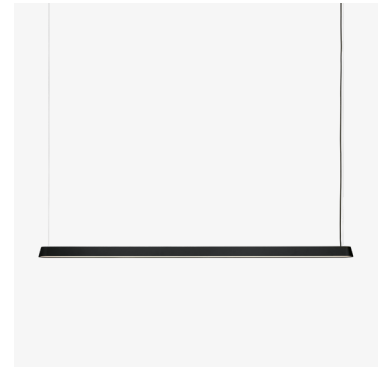
Warranty

5 years

Ready-To-Ship Options

Black (RAL 9011) 

Grey (RAL 7044) 





Linear Pendant Lamp

Materials

Pressure-die casted and extruded, powder coated aluminum. PVC cord.

Specifications

L 87,2 cm: White ceiling cap included. Integrated, non-replaceable LED bulb. 20,3W / 3000K, 3 steps. 1060 lm. Lumen maintenance of 48.000 hours. IP20 

L 169,2 cm: White ceiling cap included. Integrated, non-replaceable LED bulb. 37,7W / 3000K, 3 steps. 1880 lm. Lumen maintenance of 48.000 hours. IP20 


Energy classification


G

Warranty

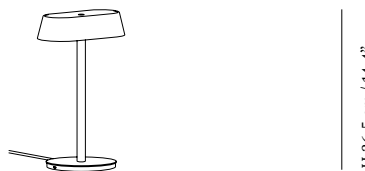
5 years

Ready-To-Ship Options

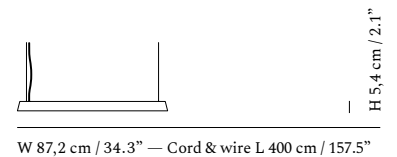
Black (RAL 9011) 

Grey (RAL 7044) 

lighting



W 23,2 cm / 9.1" — Cord L 250 cm / 98.4"



W 87,2 cm / 34.3" — Cord & wire L 400 cm / 157.5"



W 169,2 cm / 66.6" — Cord & wire L 400 cm / 157.5"

set table lamp

by Jamie Wolfond

With its distinctive blend of industrial and sculptural design, the Set Lamp features an upward-facing light that shines through an aluminum shade, emitting a bright yet indirect glow. The lamp's adjustable shade height, facilitated by threads on the body, allows for a tactile rotation and enables personalized changes in angle and light intensity. This unique lamp exudes character and seamlessly blends into a variety of spaces—making a bold statement as a distinctive centerpiece.







Set Table Lamp

Materials

Body and shade are in anodized aluminum. The underside of the shade is powder-coated aluminum. Light can be controlled using the inline dimmer or rotating the lamp shade.

Specifications

Dimmable, integrated, and non-user replaceable LED light designed for Right to Repair (only an electrician can replace the light source). 18W / 2700K. 800lm on 100% brightness. Lumen maintenance (80%) of 50,000 hours. IP20    

Energy classification

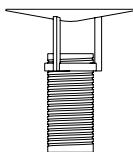
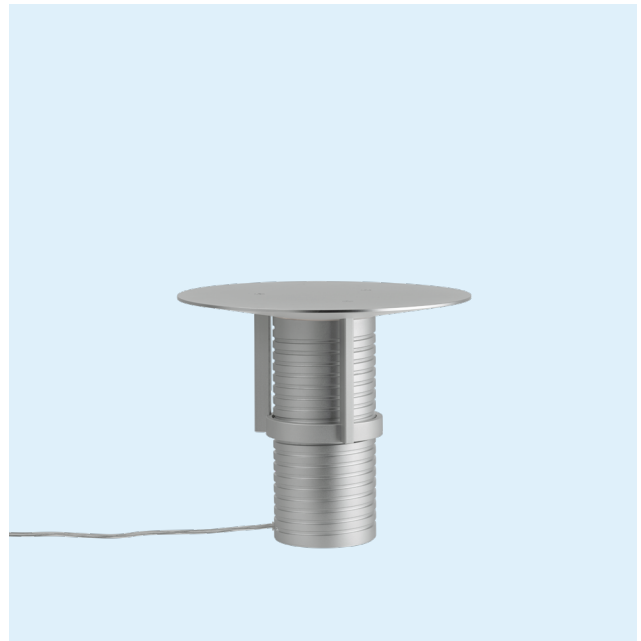
F

Warranty

5 years

Ready-To-Ship Options

Aluminum (RAL 7044)



Ø 34 cm / 13.39"

H 37.9 cm / 14.92"

dedicate lamp series

by Thomas Bentzen

The Dedicate Lamp is a contemporary take on the classic architect lamp, where design meets functionality seamlessly. Meticulously engineered, the lamp offers integrated cooling ribs, quality lighting, dimming, and an auto-turn-off feature — while guaranteeing steadiness through its flexible arms.

220







Dedicate Lamp
— S1

Materials

Lamp head and hinges in die-casted aluminum, lamp arms in extruded aluminum. All powder coated. Diffuser in injection molded plastic. Table base in machined steel. Clamp in die-casted aluminum and screw in stainless steel. Fixing Pin in machined steel screw and fixing nut. Wall Mount in die-casted aluminum.

Specifications

Integrated, dimmable, non-user replaceable LED light source. 14W / 3000K. 750lm on 100% brightness. Lumen Maintenance of 35.000 hours. The lamp comes with a built-in 8-hour timer. IP20    


Energy specification


F

Warranty

5 years

Ready-To-Ship Options

Black (RAL 9011) 

Brown Green (NCS S 6030-G90Y) 







Dedicate Lamp
— S2

Materials

Lamp head and hinges in die-casted aluminum, lamp arms in extruded aluminum. All powder coated. Diffuser in injection molded plastic. Table base in machined steel. Clamp in die-casted aluminum and screw in stainless steel. Fixing Pin in machined steel screw and fixing nut. Wall Mount in die-casted aluminum.

Specifications

Integrated, dimmable, non-user replaceable LED light source. 14W / 3000K. 750lm on 100% brightness. Lumen Maintenance of 35.000 hours. The lamp comes with a built-in 8-hour timer. IP20    


Energy specification


F

Warranty

5 years

Ready-To-Ship Options

Black (RAL 9011) 

Brown Green (NCS S 6030-G90Y) 







Dedicate Lamp
— L2

Materials

Lamp head and hinges in die-casted aluminum, lamp arms in extruded aluminum. All powder coated. Diffuser in injection molded plastic. Table base in machined steel. Clamp in die-casted aluminum and screw in stainless steel. Fixing Pin in machined steel screw and fixing nut. Wall Mount in die-casted aluminum.

Specifications

Integrated, dimmable, non-user replaceable LED light source. 14W / 3000K. 750lm on 100% brightness. Lumen Maintenance of 35.000 hours. The lamp comes with a built-in 8-hour timer. IP20    


Energy specification


F

Warranty

5 years

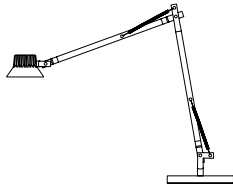
Ready-To-Ship Options

Black (RAL 9011) 

Brown Green (NCS S 6030-G90Y) 

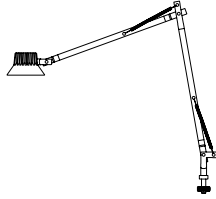
lighting

Available in various sizes, the Dedicate Lamp caters to diverse lighting needs and design preferences, providing a versatile lighting solution.



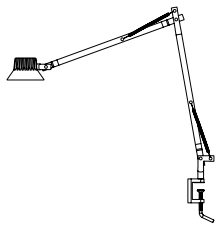
H 51,6 cm / 20.3"

Table Lamp — L2
Table Base Ø 19 cm / 7.48"



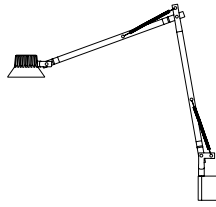
H 49,4 cm / 19.45"
Fixing Pin H 5 cm / 1.97"

Table Lamp w. Fixing Pin — L2



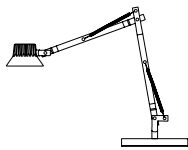
H 49,4 cm / 19.45"
Clamp H 7 cm / 2.76"

Table Lamp w. Clamp — L2



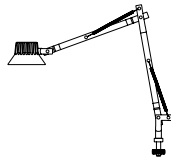
H 49,4 cm / 19.45"
Clamp H 7 cm / 2.76"

Wall Lamp — L2



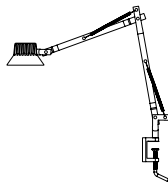
H 39,8 cm / 15.7"

Table Lamp — S2
Table Base Ø 19 cm / 7.48"



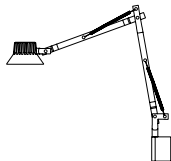
H 37,6 cm / 14.8"
Fixing Pin H 5 cm / 1.97"

Table Lamp w. Fixing Pin — S2



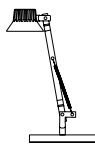
H 37,6 cm / 14.8"
Clamp H 7 cm / 2.76"

Table Lamp w. Clamp — S2



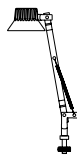
H 37,6 cm / 14.8"
Clamp H 7 cm / 2.76"

Wall Lamp — S2



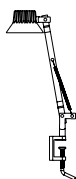
H 36,8 cm / 14.5"

Table Lamp — S1
Table Base Ø 19 cm / 7.48"



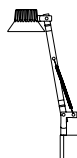
H 34,7 cm / 13.66"
Fixing Pin H 5 cm / 1.97"

Table Lamp w. Fixing Pin — S1



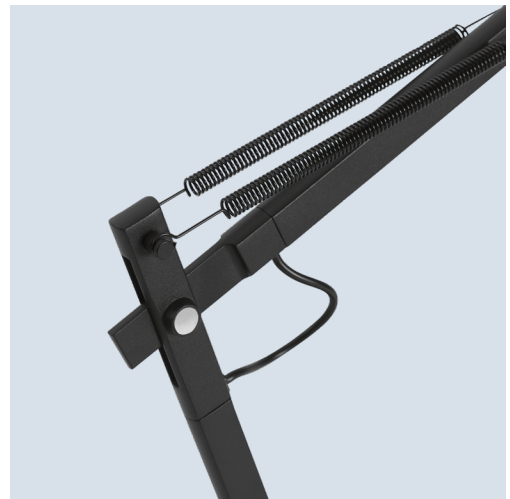
H 34,7 cm / 13.66"
Clamp H 7 cm / 2.76"

Table Lamp w. Clamp — S1



H 34,7 cm / 13.66"
Clamp H 7 cm / 2.76"

Wall Lamp — S1



beam table lamp

by Tom Chung

With light shone from both ends of Beam Table Lamp's cylinder shape, the user can choose between three different volumes of light and gradually alter the volume of light emitted in each end through the turn of a playful dial. The Beam Table Lamp can be altered for any position with its rotating base and sleek body, whether it be as direct lighting or for an ambient glow.




Beam Table Lamp



Materials

Extruded aluminum. PVC cord. Diffuser in opaque polycarbonate.

Specifications

Integrated, non-replaceable LED bulbs. 2 x 10,5W / 2700K. On-off dimmer. 425 lm. Lumen maintenance of 35.000 hours. IP20   

Energy classification


G


Warranty

5 years

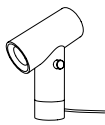
Ready-To-Ship Options

Black (Pantone 7547U) 

Aluminum (Pantone 10394C) 

Umber (Pantone 7610U) 

Green (Pantone 10313C) 



H 26,2 cm / 10.3"

W 18,7 cm / 7.4" — Cord L 250 cm / 98.4"

piton portable lamp

by Tom Chung

Piton is an untraditional take on the battery-powered portable lamp, playfully referencing the archetypal flashlight. It is a versatile ambient light with 6 hours of battery life that can be used laying down, standing, tilting on a shelf or suspended, depending on the space or spot you want to illuminate, effortlessly moving between indoors and outdoors.

Piton Portable Lamp



Materials

Body in anodized extruded aluminum. Lamp shade in injection molded plastic with an integrated and replaceable LED light bulb. Comes with a weaved fabric USB-C cable for charging.

Specifications


Battery: Lithium-ion, 5200mAh, 6 hours of battery life on 100% intensity, 13,5 hours on 50% intensity. Integrated, dimmable, replaceable LED module. 1 x 3.2W / 2700K. 210lm. Lumen maintenance 54.000 hours.


CE   

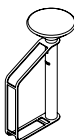
Warranty

5 years

Ready-To-Ship Options

Black (RAL 9005) 

Aluminum (RAL 9006) 



H 32,1 cm / 12.6"

W 21,8 cm / 8.6" — Cable L 300 cm / 118.1"

ease portable lamp

by Johan Van Hengel

Ease offers a high-quality dimmable, no-glare light with three levels, striking a balance between atmospheric and functional light. Ease Portable Lamp is a humble friend with a strong character that works alone or in repetition in any setting; from outdoor settings, restaurants or cafés to home offices, co-working spaces or libraries.



Ease Portable Lamp

Material

Body and lampshade in injection-molded ABS plastic, with an integrated LED light source. Diffuser in opal acrylic. Charging dock made in injection-molded ABS plastic with USB-C cable.

Warranty

5 years

Specifications

Battery: Lithium-ion, 7800mAh, 8 hours of battery life on 100% intensity, 16 hours on 50% intensity and 29 hours on 25% intensity. Integrated, dimmable LED module. 1 x 4W / 2700K. 230lm on 100%. Lumen maintenance >52.000 hours.
 CE IP54

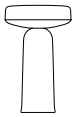
Ready-To-Ship Options

Black (RAL 9011)

Grey (RAL 7044)

Taupe (RAL 7006)

Light Blue (NCS S 2020-R90B)



H 21,5 cm / 8.5"

W 13,2 cm / 5.2" — Charger cable L 90 cm / 35.4"

portable charging station

A charging tray unit allows one to charge 8 Ease Portable Lamps at the same time. The system is scalable, as it allows one to stack trays, and the unit is easily made mobile by placing it on top a standard Euro container Dolly or trolley. This makes it a solution that fits the needs and requirements of a broad customer range; from small cafés and restaurants to large conference centers and hotels.



Portable Charging Station

Materials

Sheet metal, aluminum handles, ABS Charging docks.

Specifications

Scalable system that allows up to 3 charging trays to be stacked on top of each other. Dimensions on the charging tray is compatible to a standard Euro container Dolly or trolley. A dolly or trolley is not offered by Muuto.

Warranty

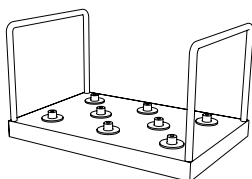
5 years

Ready-To-Ship Options

Black

Dimensions

Height: 35 cm / 13.78"
 Width: 60 cm / 23.62"
 Depth: 40 cm / 15.75"
 Height on tray incl. charging dock: 8 cm / 3.1"
 Cord length: 250 cm / 98.43"



H 35 cm / 13.78"

W 60 cm / 23.62" 40 cm / 15.75"

accessories



furniture⁹¹
outdoor¹⁹⁶
lighting²⁰³



Arrange Desktop Series
— by Big-Game

Config. 1. Choose from a prearranged configuration or create your own from 3 sizes of Trays and 2 Lids.

Materials
Trays made with 100% recycled PP. Lid in cork.

Ready-To-Ship Options
Grey / Cork.

Dimensions
L 32 cm / 12.6" x W 25 cm / 9.6" x H 11 cm / 4.3"



Arrange Desktop Series
— by Big-Game

Config. 2. Choose from a prearranged configuration or create your own from 3 sizes of Trays and 2 Lids.

Materials
Trays made with 100% recycled PP. Lid in anodized aluminum.

Ready-To-Ship Options
Brown Green / Grey / Light Blue / Anodized Aluminum

Dimensions
L 32 cm / 12.6" x W 25 cm / 9.6" x H 10 cm / 3.9"



Sketch Toolbox
— by Thomas Bentzen

Materials
Produced using 100% recycled ABS plastic from post-consumer waste.

Ready-To-Ship Options
Grey, Midnight Blue, Burnt Orange.

Dimensions
H 16,5 cm / 6.5" x W 26 cm / 10.2" x D 17,5 cm / 6.9"



Story Pinboard
— by Big-Game

Materials
Cork.

Ready-To-Ship Options
Cork

Dimensions
H 21,7 cm / 8.5" x W 28,5 cm / 11.2" x D 9 cm / 3.5"



Compile Bookend
— by Cecilie Manz

Materials
Powder coated steel.

Ready-To-Ship Options
Beige-Green, Plum, Grey

Dimensions
H 19,5 cm / 7.7" x W 15 cm / 5.9" x D 20 cm / 7.9"



Reduce Paper Bin
— by Studio Tolvano

Materials
Produced using 100% recycled ABS plastic from post-consumer waste.

Ready-To-Ship Options
Anthracite, Dark Red, Grey, Light Green.

Dimensions
H 36 cm / 14.17" x W 31,9 cm / 12.56" x D 20,4 cm / 8.03"



Restore Round Basket
— by Mika Tolvanen

Materials
Polymer PET felt.

Ready-To-Ship Options
Black, Grey Mélange, Dusty Green, Midnight Blue, Black Mélange, Brown Green.

Dimensions
H 23 cm / 9" x Ø 52 cm / 20.5"



Restore Basket
— by Mika Tolvanen

Materials
Polymer PET felt.

Ready-To-Ship Options
Black, Black Mélange, Grey Mélange, Sand, Dusty Green, Midnight Blue, Burnt Orange, Dark Green, Light Blue, Beige Green, Dusty Lilac, Brown Green, Dark Brown.

Dimensions
H 23 cm / 9" x W 35 cm / 13.75" x L 48 cm / 19"



Restore Tray
— by Mika Tolvanen

Materials
Polymer PET felt.

Ready-To-Ship Options
Grey Mélange, Dusty Green, Midnight Blue, Black Mélange, Sand, Light Blue, Brown Green.

Dimensions
H 12 cm / 4.75" x W 32 cm / 12.5" x D 39 cm / 15.5"

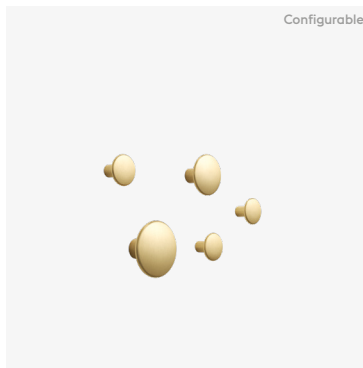


Dots — Wood
— by Lars Tornøe

Materials
Polished and oiled wood in either oak, ash or walnut. Colored versions in ash wood.

Ready-To-Ship Options
Oak, Ash, Black, Grey, Off-White, Taupe, Stained Dark Brown, Sage Green, Dusty Green, Dark Green, Light Blue, Pale Blue, Midnight Blue, Burgundy, Burnt Orange, Brown Green, Walnut*, Dark Grey*.
*Subject to stock availability across sizes.

Dimensions
Extra Small: Ø 6,5 cm / 2.5" x D 3 cm / 1.25"
Small: Ø 9 cm / 3.5" x D 3,5 cm / 1.5"
Medium: Ø 13 cm / 5" x D 4,4 cm / 1.75"
Large: Ø 17 cm / 6.75" x D 5,7 cm / 2.25"

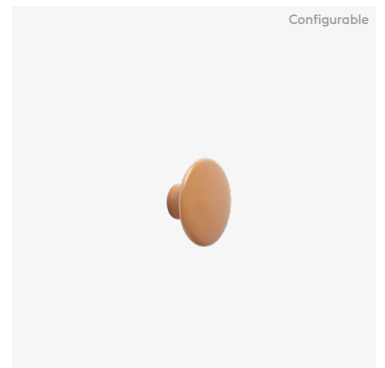


Dots — Metal
— by Lars Tornøe

Materials
Anodized solid aluminum.

Ready-To-Ship Options
Brass, Aluminum, Black, Pale Blue*, Umber*, Taupe*, Dark Green, Rose, Light Green, Lilac.
*Subject to stock availability across sizes.

Dimensions
Small: Ø 2,7 cm / 1" x D 2,2 cm / 0.9"
Medium: Ø 3,9 cm / 1.5" x D 2,7 cm / 1.1"
Large: Ø 5 cm / 2" x D 3,2 cm / 1.25"



Dots — Ceramic
— by Lars Tornøe

Materials
Earthenware with reactive glaze.

Ready-To-Ship Options
Light Blue, Burnt Orange.

Dimensions
Medium: Ø 13 cm / 5" x D 4,4 cm / 1.75"



Attach Coat Hook
— by Dimitri Bähler

Materials

Oak and aluminum, colored with anodize-treated surface.

Ready-To-Ship Options

Dark Green/Oak, Aluminum/Oak, Black/Oak, Burnt Orange/Oak, Pale Blue/Oak.

Dimensions

H 6,3 cm / 2.5" x W 2,1 cm / 0.8" x D 5,1 cm / 2"



Coil Coat Rack
— by Lars Tornøe

Materials

Anodized aluminum.

Ready-To-Ship Options

Black, Plum, Dark Green

Dimensions

60 cm
H 9,5 cm / 3.7" x L 60 cm / 23.6" x D 6,5 cm / 2.6"

100 cm

H 9,5 cm / 3.7" x L 100 cm / 39.4" x D 6,5 cm / 2.6"



Avail Coat Rack
— by Sam Hecht & Kim Colin

Materials

Rack and dots in FSC™-certified oak that is either oiled or lacquered. Hooks in powder coated steel.

Ready-To-Ship Options

Oak/Black, Oak/Grey, Oak/Copper Brown, Grey/Grey.

Dimensions

L 87,5 cm / 34.4" x H 7,0 cm / 2.7" x D 3,8 cm / 1.5"



Folded Shelves
— by Johan van Hengel

Materials

Acrylic powder coated bended 1.5 mm / 0.06" sheet of steel.

Ready-To-Ship Options

Black, Grey, Olive, Blue-Grey, Burnt Orange, Deep Red.

Dimensions

96 x 13 cm / 37.75 x 5"
H 13 cm / 5" x W 96 cm / 37.75" x D 11,4 cm / 4.5"

63 x 16,5 cm / 24.75 x 6.5"
H 16,5 cm / 6.5" x W 63 cm / 24.75" x D 2,4 cm / 4.75"

51 x 22 cm / 20 x 8.75"
H 22 cm / 8.75" x W 51 cm / 20" x D 6,9 cm / 2.75"

29,5 x 40 cm / 11.5 x 15.75"
H 40 cm / 15.75" x W 29,5 cm / 11.5" x D 8 cm / 3.1"

Folded Platform

H 5,4 cm / 2.12" x W 62 cm / 24.4" x D 19 cm / 7.48"



Framed Mirror
— by Anderssen & Voll

Materials

Powder coated steel. Mirror glass sheet.

Ready-To-Ship Options

Rose/Rose, Rose/Clear, Grey/Clear, Taupe/Taupe, Taupe/Clear, Dark Green/Clear.

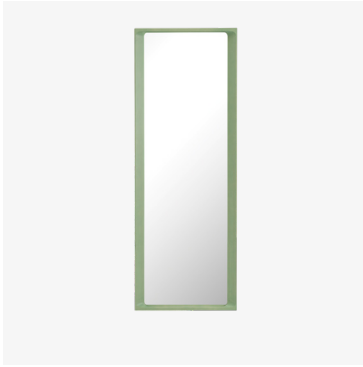
Dimensions

Large

H 118 cm / 46.5" x W 44,5 cm / 17.5" x D 4 cm / 1.5"

Small

H 59 cm / 23.25" x W 44,5 cm / 17.5" x D 4 cm / 1.5"



Arced Mirror
— by Rhys Cooper

Materials

Frame made from FSC™-certified spruce wood. Clear mirror glass. The spruce wood frame is treated with a wood stain color and finished with a clear matte lacquer. The backside is enclosed by a black backboard.

Ready-To-Ship Options

Light Grey, Light Lilac, Light Green.

Dimensions

80 x 55 cm / 31.5 x 21.65"

H 80 cm / 31.5" x W 55 cm / 21.65" x D 5,1 cm / 2.01"

170 x 61 cm / 66.9 x 24"

H 170 cm / 66.9" x W 61 cm / 24" x D 5,1 cm / 2.01"



Ridge Vase
— by Studio Kaksikko

Materials

Terracotta version made from terracotta. Off-White version made from earthenware. Glazed on the inside and raw on the outside.

Ready-To-Ship Options

Terracotta, Off-White, Beige.

Dimensions

H 48,5 cm / 19"

H 48,5 cm / 19" x W 31 cm / 12.2" x D 10,8 cm / 4.3"

H 35cm / 13.8"

H 35 cm / 13.8" x W 23,3 cm / 9.2" x D 8,6 cm / 3.4"

H 16,5 cm / 6.7"

H 16,5 cm / 6.7" x W 20 cm / 7.9" x D 6 cm / 2.4"



Kink Vase
— by Earnest Studio

Materials

Pigmented Porcelain. Glazed on the inside, raw on the outside. Small variations in the surface and color of the object are a natural and unique trait of the material.

Ready-To-Ship Options

Sand, Light Blue, Dusty Lilac.

Dimensions

H 26,3 cm / 10.4" x W 27,4 cm / 10.8" x D 12,9 cm / 5"



Silent Vase
— by Andreas Engesvik

Materials

Mouth-blown glass.

Ready-To-Ship Options

Clear, Dark Green, Burnt Orange.

Dimensions

H 13,4 cm / 5.25" x Ø 11 cm / 4.25"

H 19 cm / 7.5" x Ø 15 cm / 6"

H 23 cm / 9" x Ø 20 cm / 7.9"



Platform Tray
— by Sam Hecht & Kim Colin

Materials

Tray in ABS, insert in laminated oak veneer.

Ready-To-Ship Options

Dark Red, Grey, Dark Green, Blue-Grey.

Dimensions

Ø 30 cm / 11.75" x H 7,2 cm / 2.75"



Raise Carafe & Glasses
— by Broberg & Ridderstråle

Materials

Mouth-blown glass.

Certificates

Raise is Food & Contact approved in EU & US.

Ready-To-Ship Options

Clear, Burnt Orange, Dark Blue

Dimensions

Carafe

H 22 cm / 8.7" x Ø 11 cm / 4.3"
Diameter top: 6,7 cm / 2.6"

Drinking Glass — 20 cl

H 8 cm / 3.1" x Ø 8 cm / 3.1"
Ø Bottom: 5,3 cm / 2.1"

Drinking Glass — 30 cl

H 10,5 cm / 4.1" x Ø 8,4 cm / 3.3"
Ø Bottom: 5,3 cm / 2.1"



Corky Carafe & Glasses
— by Andreas Engesvik

Materials

Carafe: Glass and granulated cork

Glasses: Glass

Certificates

Corky is Food & Contact approved in EU & US.

Ready-To-Ship Options

Clear, Grey.

Dimensions

Carafe: H 22,1 cm / 8.75" x Ø 9,9 cm / 4"

Drinking Glass — Tall: H 10 cm / 4" x Ø 8,5 cm / 3.5"

Drinking Glass — Low: H 6 cm / 2.5" x Ø 8,5 cm / 3.5"



Wave Tray
— by Cara / Davide

Materials

Stainless steel.

Certificates

Wave Tray is Food & Contact approved in EU & US.

Ready-To-Ship Options

Steel

Dimensions

Ø 50 cm / 19.7" x H 4 cm / 1.57"



Mere Bowl
— by Studio Kaksikko

Materials

Made in ceramic stoneware with a high gloss glaze inside & out. The production process makes each bowl unique with small deviations in color, thickness and surface.

Ready-To-Ship Options

Brown Green, Light Green, Off-White.

Dimensions

51,5 x 21,5 cm / 20.5 x 8.5"

L 51,5 cm / 20.5" x W 21,5 cm / 8.5" x H 7,5 cm / 2.95"

52 x 36 cm / 20.5 x 14"

L 52 cm / 20.5" x W 36 cm / 14" x H 8 cm / 3.15"



Tub Jug
— by Atelier BL119

Materials

Stoneware with glaze.

Certificates

Tub Jug is Food & Contact approved in EU & US.

Ready-To-Ship Options

Pale Blue, Dark Green.

Dimensions

H 23,9 cm / 9.4" x W 15,5 cm / 6.1" x D 7,1 cm / 2.8"

rugs

Rugs have the ability to not just form a soft and inviting environment, but to also create a space within a space —framing it— truly defining an atmosphere. Explore our wide selection of rugs across styles, sizes and colors to complete your setting.

230



Pebble Rug

— by Margrethe Odgaard






Materials

Made from 100% New Zealand wool. Backing made of 100% cotton, pasted with synthetic latex.

Certificates

US Flammability 16 CFR part 1630 / 1631.

Ready-To-Ship Options

- Pale Rose 
- Burnt Orange 
- Light Grey 
- Pale Blue 
- Brown Green 

Dimensions

170 x 240 cm / 66.9 x 94.5"

Width:

170 cm / 66.9"

Length:

240 cm / 94.5"

200 x 300 cm / 78.7 x 118.1"

Width:

200 cm / 78.7"

Length:

300 cm / 118.1"

accessories



Ply Rug

— by Margrethe Odgaard

Materials

100% New Zealand wool.

Options

Rug pad

Certificates

US Flammability 16 CFR part 1630 / 1631.

Ready-To-Ship Options

- Rose* 
- Dark Grey* 
- Off-White 
- Yellow 
- Black / White 
- Burnt Orange* 
- Midnight Blue* 
- Light Rose 
- Grey 

Dimensions

85 x 140 cm / 33.5 x 55.1"

Width:

85 cm / 33.5"

Length:

140 cm / 55.1"

80 x 200 cm / 31.5 x 78.7"

Width:

80 cm / 31.5"

Length:

200 cm / 78.7"

170 x 240 cm / 66.9 x 94.5"

Width:

170 cm / 66.9"

Length:

240 cm / 94.5"

200 x 300 cm / 78.7 x 118.1"

Width:

200 cm / 78.7"

Length:

300 cm / 118.1"

270 x 360 cm / 106.3 x 141.7"

Width:

270 cm / 106.3"

Length:

360 cm / 141.7"

240 x 240 cm / 93 x 93"

Width:

240 cm / 93"

Length:

240 cm / 93"

280 x 280 cm / 110 x 110"

Width:

280 cm / 110"

Length:

280 cm / 110"

*Subject to stock availability across sizes.



Relevo Rug

— by Studiopepe

Materials

Made from 100% New Zealand wool, hand-tufted in India. Backing made of 100% cotton, pasted with synthetic latex.

Certificates

US Flammability 16 CFR part 1630 / 1631.

Ready-To-Ship Options

Burnt Orange



Dark Green



Off-White



Sage Green



Dimensions

170 x 240 CM / 5'6" x 7'9"

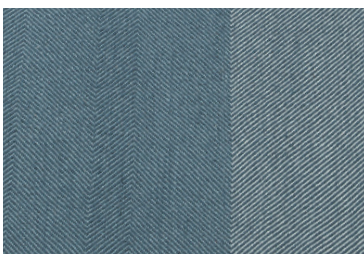
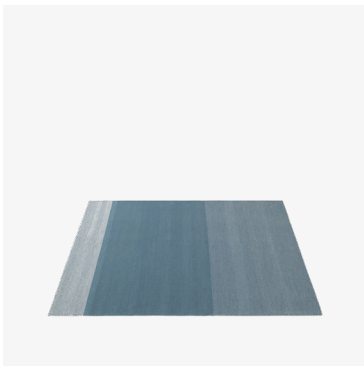
Width: 170 cm / 67"

Length: 240 cm / 94.5"

200 x 300 CM / 6'5" x 9'8"

Width: 200 cm / 79"

Length: 300 cm / 118"



Varjo Rug

— by Tina Ratzer

Materials

100% New Zealand wool.

Options

Rug pad.

Certificates

US Flammability 16 CFR part 1630 / 1631.

Ready-To-Ship Options

Blue



Dark Grey



Dark Green



Yellow



Dimensions

170 x 240 cm / 66.9 x 94.5"

Width: 170 cm / 66.9"

Length: 240 cm / 94.5"

200 x 300 cm / 78.7 x 118.1"

Width: 200 cm / 78.7"

Length: 300 cm / 118.1"

find out

Artworks by

Anne Mette My Paaske @paaskemy, Malwina Kleparska @malwinakleparska, Marbless @marblesscp, Paula Atelier @paula.atelier, Lumiere Bricoleur: @lumierebricoleur, A Hint of Neon @ahintofneon_dk, Jonatan Appelfeldt @jonatan_appelfeldt, Lumiere Bricoleur @lumierebricoleur, Christina Ahm @christinaahm, Marbless Cph @marblesscph, Julie Damhus Studio @damhus, Abid Javed @abid.jav, Anders von Greffelstejn @greffelstejn, Anna Havskov @annahavskovkeramik, Anne Lind Sorth @annelindsorth, Anne Nowak @annenowak, Art-sign by Andredottir & Bobek @andredottirbobek, Astrid Svangren @astridsvangren, Atelier Plateau @atelierplateau, Boee @boee.eu, Christina Julsgaard @christinajulsgaardart, Christine Lyhne @christine_lyhne, Dorthe Hoeck Studio @dorthe_hoeck_studio, Else-Rikke Brun @else_rikkebruun, Hanna Heino @hanna_heino, Jeba Arkitekter @jeba_arkitekter, Kaja Skytte @kaja_skytte, Kirsten Schröder @schroder_kirsten, Kristel Laurits @kristelaurits, Kristine Mandsberg @kristinemandsberg, Leila Guinnefollau @leila_guinnefollau, Leise Dich Abrahamsen @leisedichabrahamsen, Lena Medvedeva @nezhno.ceramics, Lene Bodker @lene.bodker, Lisa Hartwig Ericson @leceramics, Louise Gaarmann @louise_gaarmann_, Malene Bach @malene_bach, Meyer-Lavigne @meyerlavigne, Omhu Studio @omhu.studio, OWL @owl_____, Paula Atelier @paula.atelier, Ruby Atelier @rubyatelier_, Sara Martinsen @frk_vinthermartinsen, Sara Saur & Anne M. Stahl @sarasaur & @annemstahl, Séché Studio @linneackblaehr & @laura.bilde, Stine Juul Studio

@stinejuulstudio, Stine Leth @stinelethdk, Stine Regild @stineregild, Studio Vipaaon @studio.vipaaon, Ursula Nistrup @ursulanistrup, Thora Finnsdottir @thoraprojects, Tina Hvid @tinahvid.dk, Vic Wright courtesy of BearSpace @vic_wright_studio, Rikke Stenholt @stenholtglas, Pil Precht-Storm @prechtstorm, Thora Finnsdottir @thoraprojects, @blinkenberg, August Sandgren @augustsandgrendk, Thrane Keramik @thrane_keramik, Rikke Hostrup @rikkehostrup, Rún Studio @runstudio.dk, Aske Hagenbøl Hansen @askehagenboel, T. Bork @t_b_o_r_k, Carla Freschi @bycarlafreschi, Moemoe Studios @moemoe studios, Trinne Maria Andersen @ceramicsandwood, Michael B. Chang @michaelchang.dk, Caroline Jónasdóttir @carolinejonsdottirstudio, Valerie objects @valerie_objects, Camilla Goth Glad @milla_glad, Astrid Marie Christiansen @astridmariec, Stine Juul @stinejuulstudio, Malene Bach @malene_bach, Made By Chrillesen @bychrillesen, Trine Bond @claybybond, Transparent @transpa.rent, Casa Cubista @casacubista, Mark Ebert Løvendahl @markeberts.

Thank you

Aiayu @aiayu, Alessi @alessi_official, Bornholms Kildevand @bornholms_kildevand, Egersund Weinerberger @egersund_wienerberger, Grape @grape.dk, Phanta @phanta_enterprises, Mismo Bags @official_mismo, Angulus @angulus_official, Adax @adaxbag, Bella Balou @bellabalou_, Rue de Tokyo @ruedetokyo, By Stær @bystær, Galleri Benoni @galleribenoni



Muuto Showrooms

Explore our Muuto showrooms across the world



Join Us

Sign up to our newsletter and follow us on social media to stay in the loop on our latest designs, case stories, tools, project references and much more.

professionals.muuto.com/newsletter-sign-up
instagram.com/muutodesign
pinterest.com/muuto
facebook.com/muuto
linkedin.com/company/muuto

Muuto Head Office
Østergade 36-38
DK-1100 Copenhagen,
Denmark

For more information
visit professionals.muuto.com

more



This catalog is printed on eco-friendly,
high-quality paper in Denmark by
Narayana Press.

Designers

Aiayu
Aleksiej Iskos
Anderssen & Voll
Andreas Bergsaker
Andreas Engesvik
Atelier BLI19
Benjamin Hubert
Big-Game
Broberg & Ridderstråle
CARA \ DAVIDE
Cecilie Manz
Claesson Koivisto Rune
David Geckeler
Dimitri Bähler
Earnest Studio
Form Us With Love
Hallgeir Homstvedt
Iskos-Berlin
Jamie Wolfond
Jens Fager
Johan Van Hengel
John Tree
Julien De Smedt
Lars Tornøe
Louise Campbell
Margrethe Odgaard
Mattias Ståhlbom
Mika Tolvanen
MSDS Studio
Normal Studio
Rhys Cooper
Sam Hecht & Kim Colin
Studio Kaksikko
Studiopepe
Sylvain Willenz
Søren Rose Studio
TAF Studio
Thomas Bentzen
Tina Ratzler
Tom Chung
WhatsWhat

