

FIL ROUGE 5th ELEMENT OXI
UP SCHERMI PIEGO CHIUDO
SEGUO SHARE CUBO PRONTO
CONTENITORI UNIVERSALI
JERA ENOSI E.O.S. IULIO ELITE
DELTA I-MEET NICE POINT PAUSA
CONVIVIO FUNGO SEGNO ICARO
REGOLO KYOTO PODIO LEAD
JERA SCENA NEO CHAIR TRAMA
ATHENA FORMEN GALASSIA
STAR SISTEMA CAST CIAK PRIMA
RASSEGNA ESSAI HELLÒ OSCAR
F01 F02 F03 F04 VEDETTE FICTION
TROUPE ZOOM SUPEROTTO
PROVINO F01 BENCH F03 BENCH
REGIA MOVIE TRUKA FESTIVAL
JETSET JERA22 TREND SET22
DOMUS DRIVE IN DIVO FLAGS
TRAILER WORKLAND

LAS[®]

Indice
Contents
Index

operativi - operative - operatives

Fil Rouge
5th Element
Oxi
Up

Schermi Universali
universal screens - écrans universels

tavoli multifunzione - multipurpose tables - tables multifonction

Piego
Chiudo
Seguo

smart

Share
Cubo
Pronto

contenitori - storage units - rangement

Contenitori universali

direzionali - executive - direction

Jera
Enosi
E.O.S.
Iulio
Elite
Delta

meeting

I-Meet

reception

Nice
Point

tavoli break & coffee - break & coffee tables - break & basses tables

Pausa T
Pausa P
Convivio
Fungo
Seguo coffee
Fungo coffee
Segno
Icaro
Regolo
Kyoto
Podio

010

012
022
040
058
064

078

080
084
088

094

096
102
108

114

116

128

130
140
150
156
164
176

184

186

194

196
204

212

214
215
216
217
218
219
220
221
222
224
225

sedute direzionali - executive chairs - fauteuil de direction

Lead
Jera
Scena
NeoChair
Trama
Athena
Formen
Galassia

sedute operative - operative chairs - sièges de travail

Star
Sistema
Cast
Ciak
Prima
Rassegna
Essai
Hellò
Oscar

multiuso - for all - polyvalent

F01
F02
F03
F04
Vedette
Fiction
Troupe
Zoom
Superotto
Provino

attesa & riunione - waiting & meeting - attente & réunion

F01 Bench
F03 Bench
Regia
Movie

lounge

Truka
Festival
Jetset
Jera 22
Trend
Set 22
Domus
Drive In

smart office

Divo
Flags
Trailer
Workland

finiture - finishes - finitions

230

232
236
240
244
248
252
256
260

264

266
270
274
278
282
286
290
294
298

304

306
308
310
312
314
316
318
320
322
324

326

328
330
332
334

336

338
340
342
344
346
348
350
352

354

356
360
364
366

370

About us



Il Gruppo LAS è una delle realtà industriali italiane più importanti nel settore del mobile per ufficio che unisce le competenze di tre unità produttive: mobili, sedute e pareti.

Un gruppo animato dalla volontà di un miglioramento continuo e da una ambiziosa visione aziendale spiccatamente internazionale.

Un partner forte per progetti di grande valore.

LAS Group is one of the leading office furniture manufacturers in Italy.

The group combines the skills and experience of three business and production units: furniture, chairs and partition walls.

A group driven by and oriented towards continuous improvement and open to an ambitious and strongly international business vision.

A strong partner for high standard projects.

Le Groupe LAS est l'une des plus grandes entreprises industrielles italiennes dans le secteur du mobilier de bureau, qui combine les compétences de trois unités de production: meubles, sièges et cloisons.

Un groupe animé par la volonté d'amélioration continue et une vision ambitieuse d'une entreprise tournée vers l'international.

Un partenaire fort pour mener des projets de grande valeur.

**Arredi, sedute
e pareti**
*Furniture, chairs
and partitions*
*Meubles, sièges
et cloisons*

Il Gruppo LAS produce in 5 unità operative, tutte in Italia, con superficie complessiva di 121.000 metri quadri, 250 dipendenti, 5.000 colli/giorno, 1.200 spedizioni al mese. Ha consolidato un marchio ormai presente in 76 paesi nel mondo. Spazi organizzati ed efficienti, potenza produttiva, diffusione commerciale e precisione logistica.



LAS Group can count on 5 production units, all in Italy, with a total surface of 121.000 sqm, 250 employees, 5.000 items shipped every day, 1.200 shipments per month. A consolidated brand known in 76 countries all over the world. Organised and efficient spaces, high production capacity, sales network and accurate logistics.

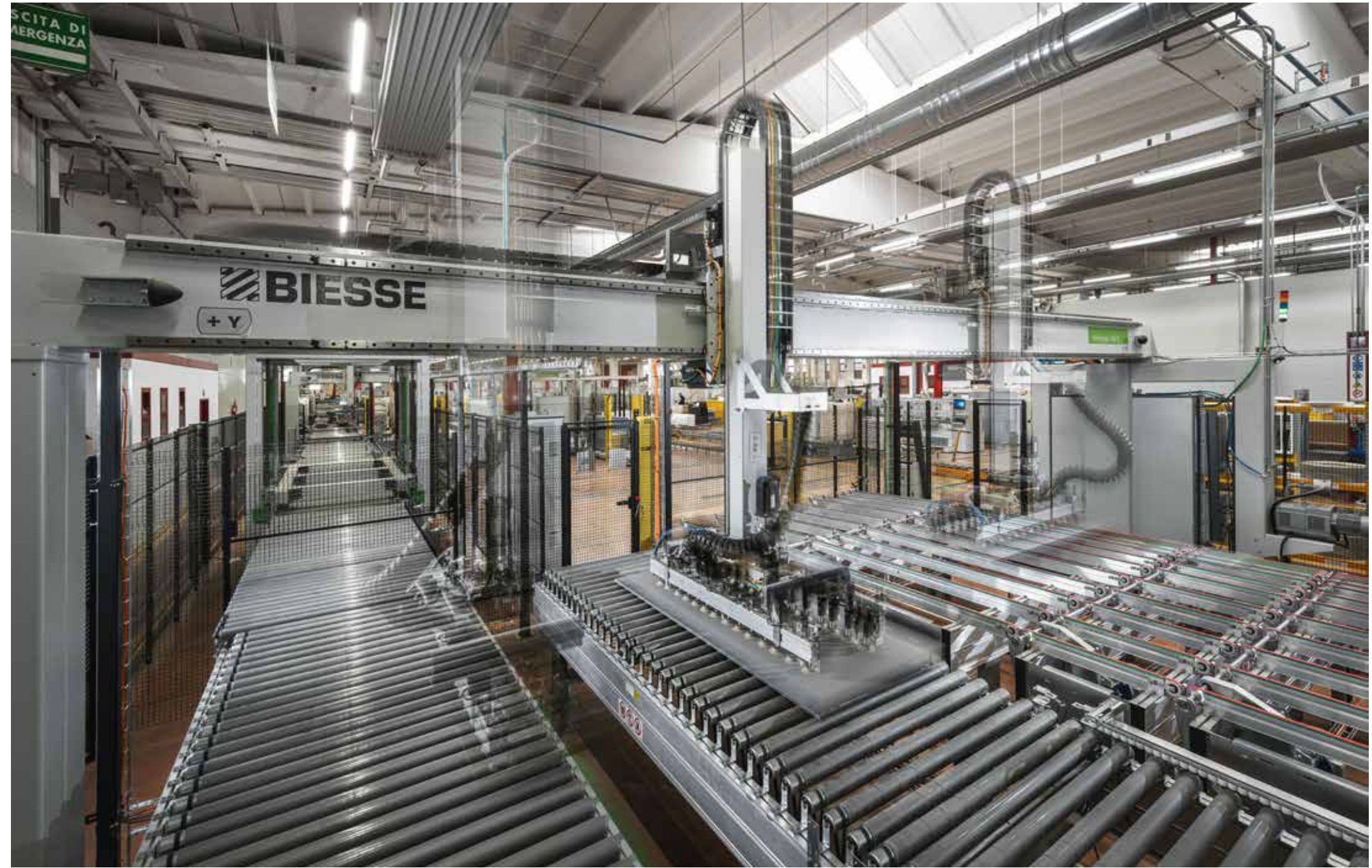

←
L'uomo al centro di ogni attività produttiva e gestionale. Attenzione ed esperienza interagiscono con la più moderna tecnologia.
Man is at the core of all production and management activities. Attention and experience interact with the most modern technologies.
L'homme est le protagoniste de l'activité de production et de gestion. L'attention et l'expérience interagissent avec la technologie la plus moderne.



La production du Groupe LAS a lieu dans 5 unités opérationnelles, toutes situées en Italie, avec une surface totale de 121.000 mètres carrés et 250 employés qui gèrent 5.000 colis par jour et 1.200 envois par mois. Aujourd'hui, la marque est présente dans 76 pays du monde. Espaces organisés et efficaces, puissance productive, diffusion commerciale et précision logistique.



→
La mano esperta
dell'uomo modella,
perfeziona e completa
ogni elemento.
Human hands that
shape, bring to
perfection and finish
each and every
element.
La main experte de
l'homme modèle,
perfectionne et
complète chaque
élément.



**Ogni prodotto è concepito
come massima espressione
di un processo industriale
perfettamente organizzato,
supportato dall'esperienza e
dalla manualità di operatori
attenti.**

Each product is designed
and manufactured as the
maximum expression of a
perfectly organised industrial
process, supported by the
experience and manual skills
of dedicated operators.

Chaque produit est
conçu comme expression
maximale d'un processus
industriel parfaitement
organisé, soutenu par
l'expertise et les habilités
manuelles d'opérateurs
attentionnés.

→
Un moderno processo
industriale integrato
da esperienza e
competenza.
A modern industrial
process integrated
with experience and
know-how.
Un processus
industriel moderne
qui s'intègre avec
l'expérience et le
savoir faire.

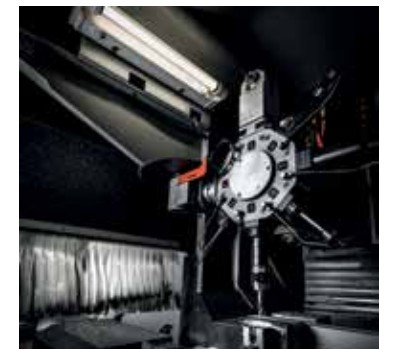

FIL ROUGE 5th ELEMENT OXI
UP SCHERMI PIEGO CHIUDO
SEGUO SHARE CUBO PRONTO
CONTENITORI UNIVERSALI
JERA ENOSI E.O.S. IULIO
ELITE DELTA I-MEET NICE POINT
PAUSA CONVIVIO FUNGO
SEGNO ICARO REGOLO KYOTO
PODIO LEAD JERA SCENA NEO
CHAIR TRAMA ATHENA FORMEN
GALASSIA STAR SISTEMA CAST
CIAK PRIMA RASSEGNA ESSAI
HELLÒ OSCAR F01 F02 F03 F04
VEDETTE FICTION TROUPE
ZOOM SUPEROTTO PROVINO
F01 BENCH F03 BENCH REGIA
MOVIE TRUKA FESTIVAL JETSET
JERA22 TREND SET22 DOMUS
DRIVE IN DIVO FLAGS TRAILER
WORKLAND

Fil Rouge

967 Arch - CSR Las Mobili





Scrivanie dall'impiego trasversale per uffici direzionali, operativi e sale riunioni. Il telaio perimetrale in alluminio, il piano incassato a filo, gli spigoli arrotondati definiscono un nuovo stile.

Versatile desks for executive and operational offices and meeting rooms. The aluminium frame, the flush-mounted top and the rounded edges define a new style.

Bureaux avec fonction transversale pour environnements exécutifs et opérationnels et salles de réunion. Le cadre périmétral en aluminium, le plateau à fleur, les bords arrondis définissent un nouveau style.

cod. 643



→
Il bordo rosso evidenzia il piano scorrevole di accesso al vano di cablaggio.
The red border outlines the sliding panel that gives access to the wiring compartment.
Le contour rouge met en évidence le plateau coulissant d'accès au compartiment de câblage.



cod. 649



cod. 68

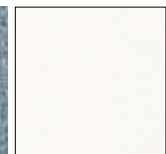

cod. BI 02



→
Mobile di servizio su ruote, con ante e maniglia in tinta.

Service unit on wheels, with doors and matching handles.

Meuble de service sur roues, avec portes et poignée en couleur.



Il contenimento è affidato a volumi rigorosi e compatti che fanno da contraltare alle forme morbide delle scrivanie. Una dialettica formale che caratterizza tutta la collezione.

Storage is provided by rigorous and compact volumes that counterbalance the desks soft shapes. A formal dialogue that characterises the entire collection.

Le rangement est organisé en volumes rigoureux et compacts qui contrastent avec les formes douces des bureaux. Une dialectique formelle qui caractérise toute la collection.



cod. 03

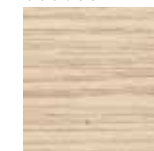



←
Le maniglie sono in tinta con l'anta per non alterare le superfici dei contenitori.
The handles and doors are in matching colours not to interrupt the storage surface aesthetics.
Les poignées sont de la même couleur que la porte pour ne pas altérer les surfaces des rangements.



cod.NR 03



cod.68

La riunione avviene su tavoli quadrati o rettangolari con top access centrale.
La scelta estetica varia dal monocolore alla variazione tra piano e struttura.

Meetings are held around square or rectangular tables, with central top access.
Aesthetic choices vary from one-colour configurations to top-and-frame combinations.

La réunion se tient autour de tables carrées ou rectangulaires avec accès central par le haut.
Le choix esthétique exploite le mono-couleur aussi bien que la variation entre le plateau et la structure.

cod.SG01

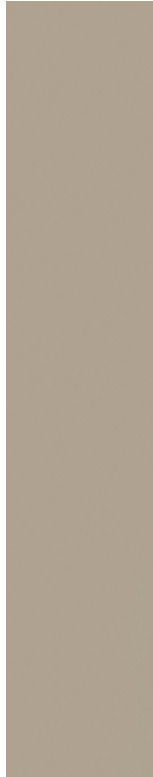

cod.44



Le grandi ante scorrevoli permettono una completa visione dell'interno.

The big sliding doors allow a complete view of the inside.

Les grandes portes coulissantes permettent une vue complète de l'intérieur.

cod.03



→
Elementi strutturali in colore bianco e piano in finitura rovere.
White structural elements and oak finished worktop.
Éléments structurels en blanc et plateau en finition chêne.



Inquadra il QrCode e scopri le finiture disponibili

Scan the QrCode and discover the available finishes

Scannez le QR Code e découvrez les finitions disponibles



Scrivanie direzionali Executive desks | Bureaux de direction

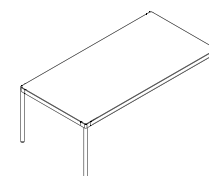

L 200,7 / 220,7 / 240,7
P 100,7
H 72,9

Scrivanie operative Operative desks | Bureaux operatifs

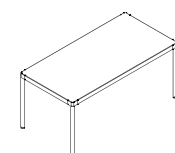

L 120,7 / 140,7 / 160,7 / 180,7
P 80,7
H 72,9

Bench Bench | Bench

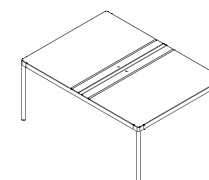

L 120,7 / 140,7 / 160,7 / 180,7
P 165,9
H 72,9

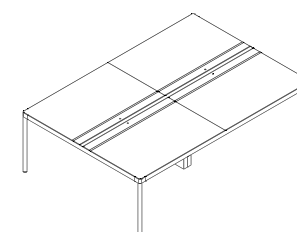

L 240,7 / 280,7 / 320,7 / 360,7
P 165,9
H 72,9

Tavoli riunione Meeting tables | Tables de réunion

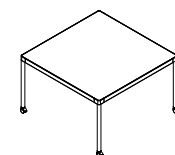

L 120,7
P 120,7
H 72,9

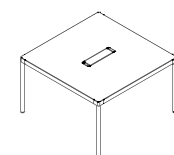

LxP 120,7 x 120,7
LxP 160,7 x 160,7
H 72,9

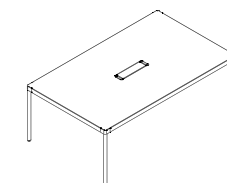

L 200,7
P 120,7
H 72,9

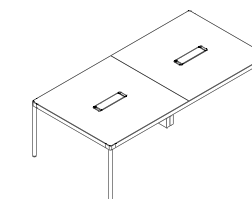

L 240,7
P 120,7
H 72,9

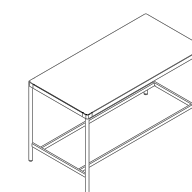

L 180,7
P 90,7
H 105

Cassettiere e mobili Pedestals and cabinets | Caissons et meubles

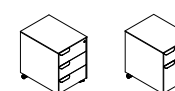

L 41,7
P 55,5
H 58,1



L 67,4
P 55,5
H 58,1

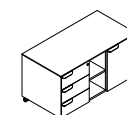

L 107,2
P 55,5
H 58,1

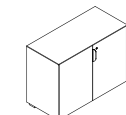

L 100
P 46,8
H1 72,9 / H2 121

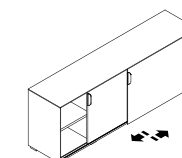
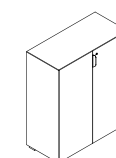

L 200
P 46,8
H1 72,9 / H2 121

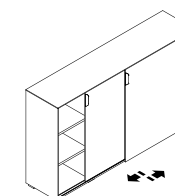

5th Element

SI Design - CSR Las Mobili





Postazioni operative a struttura condivisa completamente attrezzabili, ideali per soddisfare le esigenze di lavoro di spazi moderni e performanti. I pannelli frontali in feltro stampato definiscono le aree di lavoro e creano un ottimale comfort acustico, locale e ambientale.

Operational workstations with shared layout, ready to receive accessories and ideal to meet the needs for modern and performing work space. Front panels in printed felt outline the working areas and create optimal acoustic comfort, locally and in the whole environment.

Postes de travail avec structure partagée, entièrement équipables, parfaits pour répondre aux besoins de travailler dans des espaces modernes et performants. Les panneaux frontaux en feutre imprimé définissent les zones de travail et créent un confort acoustique, local et environnemental optimal.



← Pannelli frontali in feltro stampato con funzione acustica e di separazione.
Front panels in printed felt with acoustic and separation functions.
Panneaux frontaux en feutre imprimé avec fonction acoustique et de séparation.

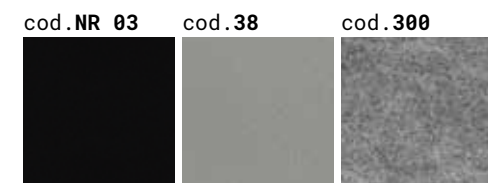

→
 Scrivanie con
 struttura in appoggio
 sui contenitori di
 servizio.
 Desks with frame
 resting on storage
 units.
 Banc avec structure en
 appui sur les meubles
 de service.



↓
 Gamba regolabile in
 altezza e riferimenti
 di misurazione.
 Adjustable leg height
 and measure references.
 Pieds à hauteur réglable
 avec références de
 mesure.

cod. 38



Postazioni ad altezza regolabile. Soluzioni che rispettano le diversità antropometriche e consentono la selezione dell'altezza dei piani in base alle esigenze più personali. Dotazioni studiate per scrivanie singole o bench che, con semplicità, migliorano il comfort e l'efficienza in ufficio.

Workstations at adjustable height. Solutions that respect anthropometric diversity and allow to select the worktop height depending on personal needs. Equipment designed for single desks or single benches to improve, in a simple way, comfort and efficiency at work.

Postes à hauteur réglable. Solutions qui respectent la diversité anthropométrique et permettent de choisir la hauteur des plateaux en fonction des exigences les plus personnelles. Équipements étudiés pour bureaux simples ou bancs simples qui, avec simplicité, augmentent le confort et l'efficacité dans l'environnement de travail.



cod. BI 02

cod. 68



I mobili di servizio assolvono perfettamente alla funzione strutturale, creando interessanti giochi di piani e volumi. Oltre al perfetto contenimento, è assicurato l'adeguato cablaggio di ogni postazione.

The service furniture perfectly meets its structural function, creating interesting games of surfaces and volumes. In addition to perfect storage, this collection ensures adequate wiring of each workstation.

Les meubles de service remplissent parfaitement leur fonction structurale et créent des jeux intéressants entre les surfaces et les volumes. Le rangement impeccable permet aussi le câblage approprié pour chaque poste.

cod. 400



→ Bench con pannello divisorio in feltro stampato in lunghezza inferiore al piano.
 Double bench with printed felt partition, shorter than the worktop.
 Double banc avec écran de séparation en feutre imprimé en longueur inférieure à celle du plateau.





cod. 03



Quando la riunione operativa è veloce e consumata tra le postazioni, l'esigenza di tavoli alti e protetti diventa una priorità.

During fast operational meetings held between workstations, the need for high and protected tables becomes a priority.

Pour les réunions opérationnelles et rapides, des tables hauts et protégés deviennent prioritaires.



→ Tavolo Team con pannelli acustici per le riunioni in piedi o su sgabelli.

Team table with acoustic panels to hold meetings, standing or sitting on stools.

Table Team avec panneaux acoustiques pour des réunions debout ou sur tabourets.

La gamba a cavalletto è l'archetipo della gamba del tavolo da lavoro. La collezione si arricchisce di una variante stilistica che si integra con ogni contenitore e accessorio.

Trestle legs are the iconic legs of work benches. This collection is enriched by a stylistic variation which integrates with storage units and accessories.

Le pied à tréteau est l'archétype du pied des tables de travail. La collection s'enrichit d'une variation de style qui s'intègre avec chaque rangement et accessoire.

cod. 59



→
La gamba metallica è in semi appoggio sul contenitore di servizio.
Metal legs are partly resting on the service storage unit.
Le pieds en métal est partiellement appuyé sur le meuble de service.





cod.63



←
 Il cablaggio della postazione è assicurato da comodi top access a ribalta.
 The workstation wiring is ensured by convenient flap-door top access traps.
 Le câblage de cette poste est assuré par le système rabattable d'accès par le dessus.

Le postazioni a bench doppio poggiano sui contenitori di servizio, utili all'archiviazione e al passaggio cavi.

Double-bench workstations rest on service storage units, that provide filing and wiring space.

Le postes à double banc sont en appui sur les meubles de service, utiles pour le classement et le passage des câbles.



cod.BI 02





La scrivania direzionale viene interpretata in modo moderno, mantenendo logiche estetiche e funzionali coerenti con la versione operativa.

Executive desks are interpreted in a modern way, maintaining aesthetic and functional logics, consistent with the operational version.

Le bureau de direction est interprété de manière moderne, en maintenant des logiques esthétiques et fonctionnelles cohérentes avec la version opérationnelle.



Inquadra il QrCode e scopri le finiture disponibili

Scan the QrCode and discover the available finishes

Scannez le QR Code e découvrez les finitions disponibles



Scrivanie direzionali Executive desks | Bureaux de direction

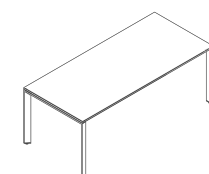

L 180 / 200 / 220
P 90
H 72,8

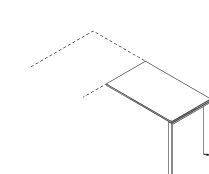
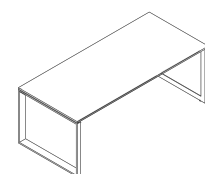

L 80 / 100
P 60
H 72,8

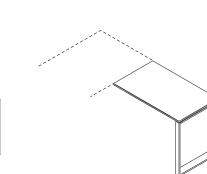

Scrivanie operative Operative desks | Bureaux operatifs

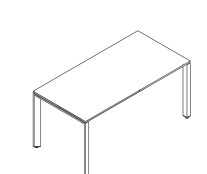

L 120 / 140 / 160 / 180
P 70 / 80
H 72,8

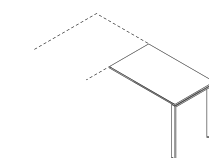
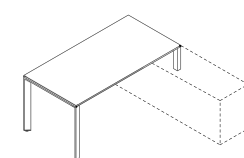
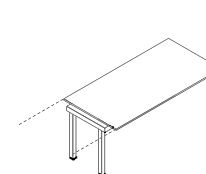

L 80 / 100
P 60
H 72,8

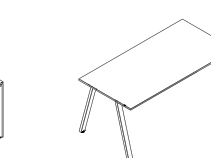

L 120 / 140 / 160 / 180
P 80
H 72,8

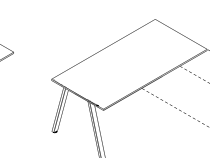
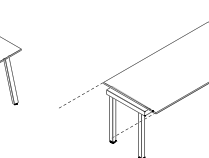

L 80 / 100
P 60
H 72,8

Bench Bench | Bench

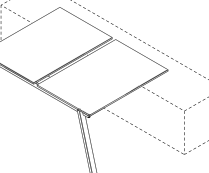
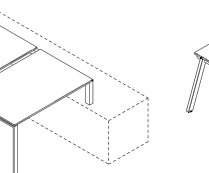
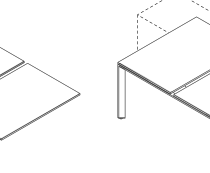
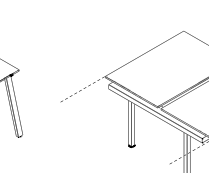
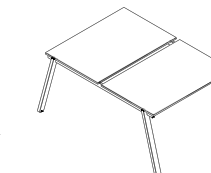
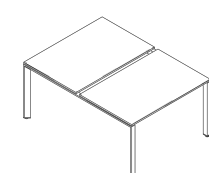

L 120 / 140 / 160 / 180
P 165,2
H 72,8

Tavoli riunione Meeting tables | Tables de réunion

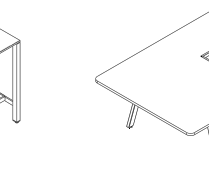
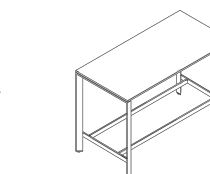
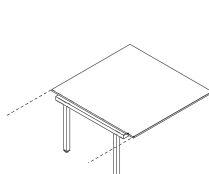
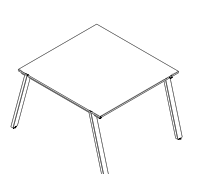
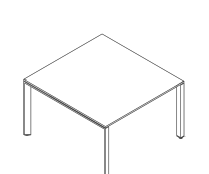

LxP 120 x 125,2 / 160 x 125,2
LxP 160 x 165,2
H 72,8

L 160 / 180
P 80
H 105

L 220
P 125,2
H 72,8

Mobili di servizio e porta-cpu Service units and cpu-holder | Meubles de service et support UC

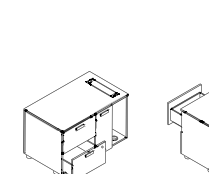

L 100
P 60
H 61,5

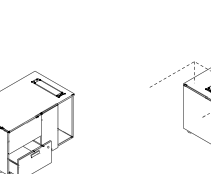

L 140
P 60
H 61,5

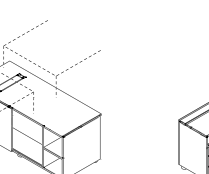

L 165
P 42
H 61,5

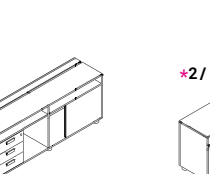

*2/
L 87,3
P 42
H 61,5

* configurazioni possibili | possible configurations | possibles configurations





↑
 Semplicità e solidità strutturale leggibili nell'unione tra piano e gamba.
 Simplicity and structural strength expressed in the junction between the worktop and the legs.
 Simplicité et solidité structurelle visibles dans la jonction entre le plateau et le pied.

cod. 03



Oxi si caratterizza per la gamba a ponte sobria e sempre attuale. Con le sue soluzioni geometriche e tecniche soddisfa qualsiasi esigenza funzionale e di layout, inserendosi perfettamente in ogni ambiente grazie anche alle numerose finiture e agli accessori.

Oxi features sober and elegant bridge legs. Thanks to its geometric and technical solutions it can meet any functional and layout needs, fitting perfectly into any environment with its many finishes and accessories.

Oxi se caractérise pour la jambe à pont, sobre et toujours actuelle. Avec ses solutions géométriques et techniques, il satisfait toutes les exigences fonctionnelles et de configuration, s'intégrant parfaitement dans n'importe quel environnement grâce aux nombreuses finitions et accessoires.

→
 La sobrietà delle forme consente un perfetto abbinamento con tutti i contenitori a catalogo.
 Sober shapes create a perfect match with all the storage options included in the catalogue. La sobriété des formes permet une correspondance parfaite avec tous les rangements du catalogue.



Postazioni articolate in aggregazioni complesse. I piani sagomati sono valorizzati dalle gambe, minimali e moderne. I piccoli schermi consentono una separazione discreta. I contenitori introducono in modo nuovo il metallo e il colore.

Diversified layouts for complex aggregations. Shaped worktops are highlighted by their minimal and modern legs. Low partition screens provide unobtrusive separation. Storage units introduce metal and colour with a new approach.

Postes de travail recherchées et complexes. Les plateaux en forme sont valorisés par les pieds, minimaux et modernes. Les petits écrans offrent une séparation discrète. Les rangements introduisent le métal et la couleur d'une nouvelle façon.

cod. CP 01



cod. 03



Le postazioni di lavoro, semplici o con piano sagomato, si integrano con contenitori di varia tipologia e dimensione e soddisfano le più diverse esigenze estetiche e funzionali, creando effetti compositivi sempre piacevoli.

The workstations, simple or with shaped top, are integrated with storage units of different dimensions to meet any aesthetic and functional needs, creating pleasant effects.

Les postes de travail, simples ou avec plateau en forme, s'intègrent avec rangements de différentes typologies pour répondre aux exigences esthétiques et fonctionnelles les plus diverses, tout en créant des compositions agréables.

← Gli abbinamenti si moltiplicano, le finiture legno, colori pieni e tinte pastello.

Multiple combinations with wood finishes, plain colours and pastel shades.

Les combinaisons se multiplient : finitions bois, teintes unies et tons pastel.



Scrivanie integrate con i contenitori Comby. Soluzioni progettate per ottenere superfici ampie e spazi di stoccaggio comodi e capienti. Isole funzionali che suddividono lo spazio creando postazioni di lavoro autonome ispirate a criteri fortemente operativi.

Integration of desks and Comby storage units. These solutions are designed to provide large surfaces and convenient storage room. Functional islands that divide spaces creating autonomous workstations, strongly inspired to operation.

Bureaux intégrés avec les rangements Comby. Solutions conçues pour obtenir des grandes surfaces et espaces de rangement amples et confortables. Îles fonctionnelles qui divisent l'espace, en créant des postes de travail autonomes inspiré par des critères fortement opérationnels.

cod. 38



Schienali dotati di rivestimenti fonoassorbenti, perfettamente attrezzabili con accessori porta cancelleria. Soluzioni studiate per migliorare l'operatività, soddisfare il gusto e migliorare l'acustica dell'intero spazio di lavoro.

Side panels are finished with sound-absorption materials and can receive accessories to hold stationery and small objects. Ideal solutions that improve functionality, meet aesthetics needs and increase acoustic isolation in the entire work space.

Dossiers avec revêtement insonorisant, qui peuvent être équipés avec accessoires porte papeterie. Solutions étudiées pour faciliter les opérations, satisfaire le goût et améliorer l'acoustique de l'ensemble de l'espace de travail.

cod. 68



cod. VR 01

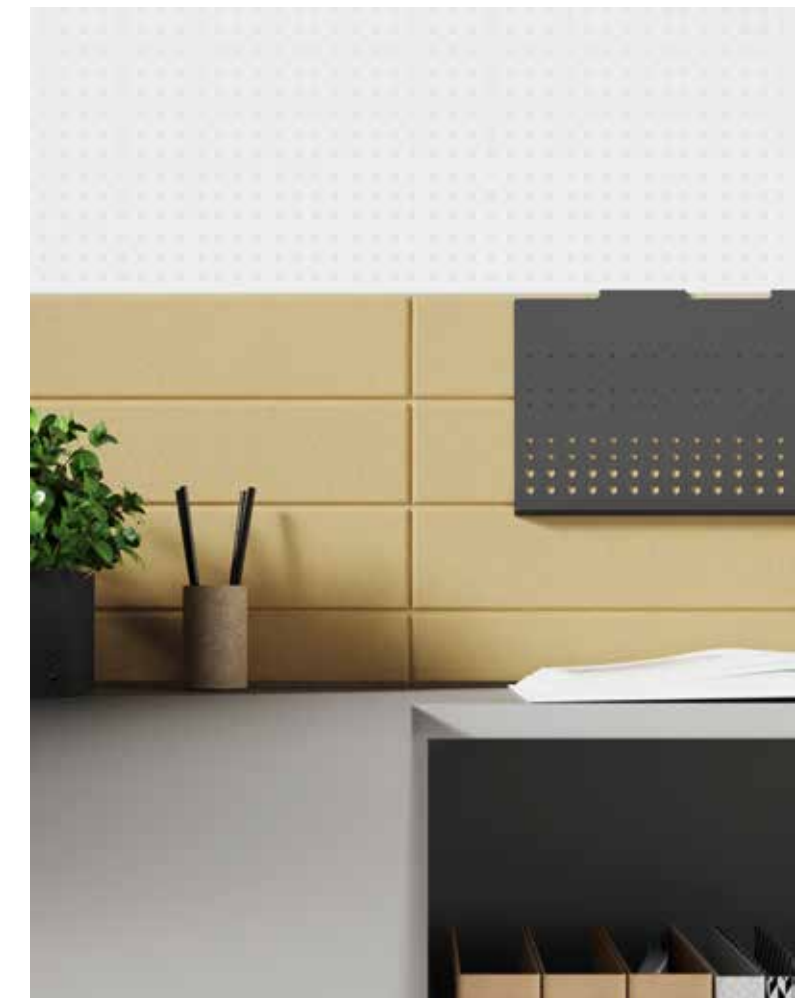
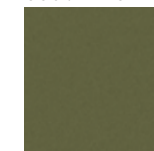



←
Tavolo riunioni
rettangolare in
versione interamente
pannellata.
Fully-panelled
rectangular meeting
table.
Tables de réunion
rectangulaire en
version avec
panneaux.

cod. 38



↓
Tavolo riunioni
rettangolare con gambe
metalliche a T.
Rectangular meeting
table with T-shaped
metal legs.
Tables de réunion
rectangulaire avec
pieds en T en métal.

cod. 03

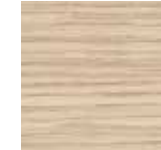

→
Cipria e Bianco creano
insieme un effetto
delicato e nuovo per
l'ufficio.

Cipria and Bianco
create together a
delicate effect, new
to the office.

Cipria et Bianco
créent, ensemble,
un nouvel effet de
délicatesse pour le
bureau.



cod. CP 01



cod. 609

↑
I contenitori
accolgono portaoggetti
metallici microforati
modulari.

Storage units are
fitted with modular
and micro-perforated
metal trays.

Les rangements
peuvent être équipés
avec porte-objets
modulaires en métal
micro-perforé.

**Le scrivanie, i contenitori
ed accessori creano
insieme composizioni
articolate e sempre nuove.
Ogni elemento con la sua
forma diventa parte di un
allestimento complesso e
stimolante.
Il colore bianco si pone
come sfondo su cui inserire
colori e forme diverse.**

Desks, storage units and
accessories together create
diversified and ever-new
configurations.
The shape of each element
becomes part of a more
complex and stimulating
layout.
The white background
invites to add colours and
shapes.

Les bureaux, les rangements
et les accessoires créent
ensemble des compositions
articulées et toujours
nouvelles. Chaque élément
s'intègre avec sa forme
dans un décor complexe
et stimulant. La couleur
blanche crée le fond sur
lequel insérer couleurs et
formes différentes.



La collezione permette molteplici abbinamenti di finiture, sia nelle scrivanie sia nei contenitori e crea gradevoli effetti cromatici.

This collection allows endless finishing combinations of desks and storage units to create pleasant colour effects.

La collection permet plusieurs combinaisons de finitions, dans les bureaux aussi bien que dans les rangements, en créant des agréables effets chromatiques.



Gli smart office cabinets presentano le innovative ante metalliche microforate pensate per vivacizzare l'allestimento ed introdurre colori di tendenza. L'alternanza dei materiali contribuisce a creare ambientazioni accattivanti che stimolano l'operatività.

Smart office cabinets are fitted with innovative micro-perforated metal doors, conceived to cheer up the combination with trendy colours. Alternating materials contribute to create attractive environments that encourage activity.

Les « smart cabinets » sont caractérisé par les modernes portes en métal micro-perforé, conçues pour animer le décor et introduire des couleurs tendance. La combinaison des matériaux contribue à créer des environnements charmants qui stimulent l'activité.

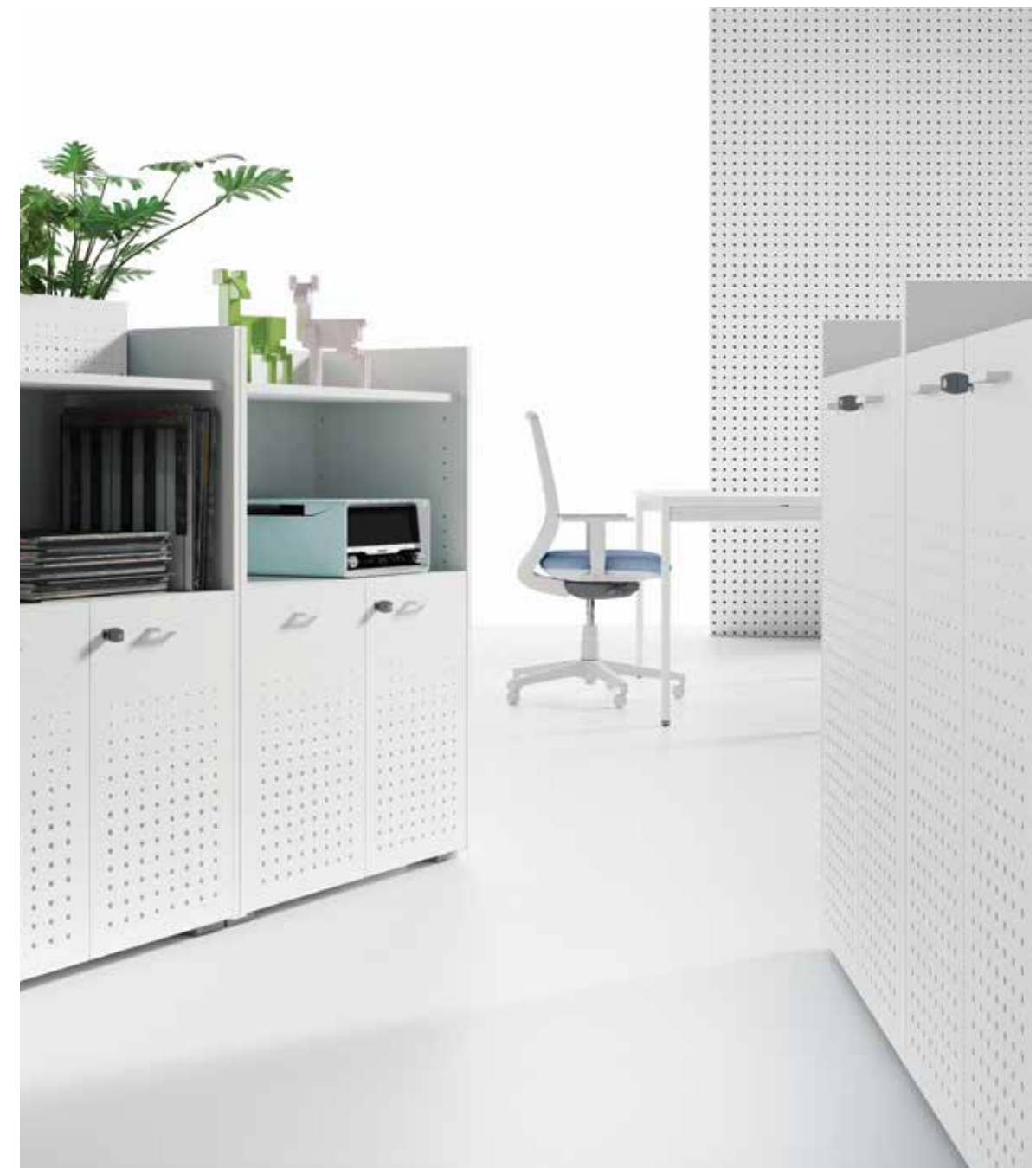

Semplici scrivanie attrezzate con contenitori a giorno o con ante metalliche a contrasto di colore. Composizioni sobrie e funzionali progettate per ottimizzare lo spazio e creare ordine ed efficienza.

Essential desks with matching storage modules, open or with metal doors in contrasting colours. Sober and functional combinations designed to optimise space and create order and efficiency.

Des simples bureaux équipés avec rangements ouverts ou avec portes en métal contraste de couleurs. Compositions sobres et fonctionnels, conçues pour optimiser l'espace et créer ordre et efficacité.

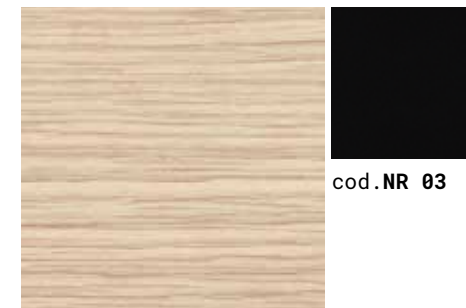

cod. 03

cod. NR 03

→
Le gambe metalliche a T, riducendo gli ingombri, favoriscono l'operatività.

T-shaped metal legs reduce the overall dimensions and facilitate operation.

Les pieds en métal en forme de T réduisent l'encombrement et sont plus fonctionnels.



Inquadra il QrCode e scopri le finiture disponibili

Scan the QrCode and discover the available finishes

Scannez le QR Code e découvrez les finitions disponibles



Scrivanie operative Operative desks | Bureaux operatifs

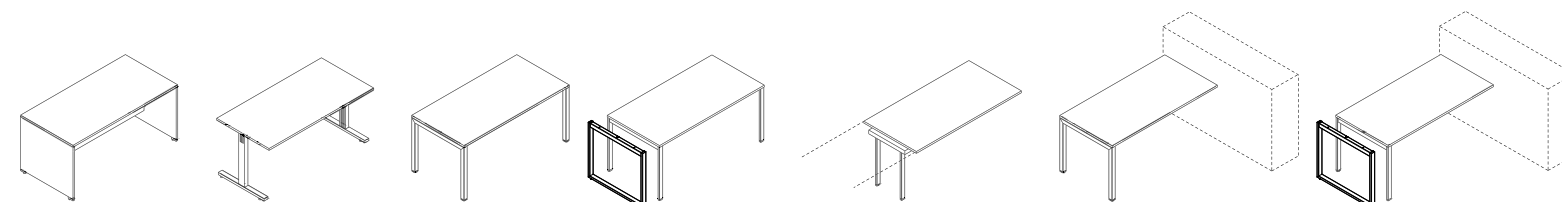

L 80 / 100 / 120 / 140 / 160 / 180
P 70 / 80
H 73,6

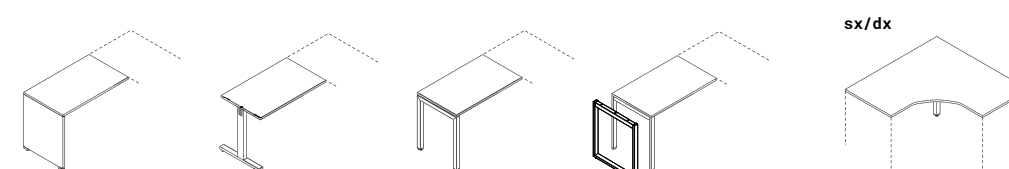

L 80 / 100
P 60
H 73,6

L 140 x 140
P 70
H 73,6

Bench Bench | Bench

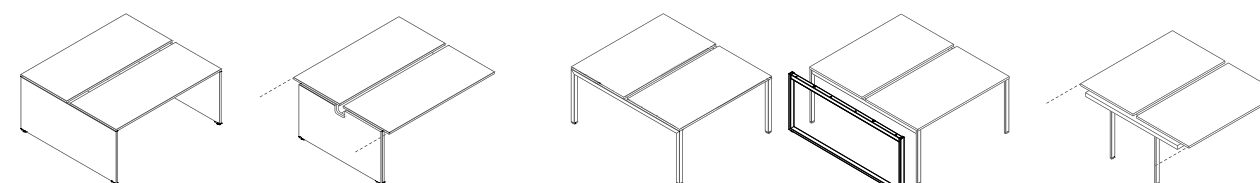

L 120 / 140 / 160 / 180
P 145,2
H 73,6

L 120 / 140 / 160 / 180
P 145,2 / 165,2
H 73,6

Tavoli riunione Meeting tables | Tables de réunion

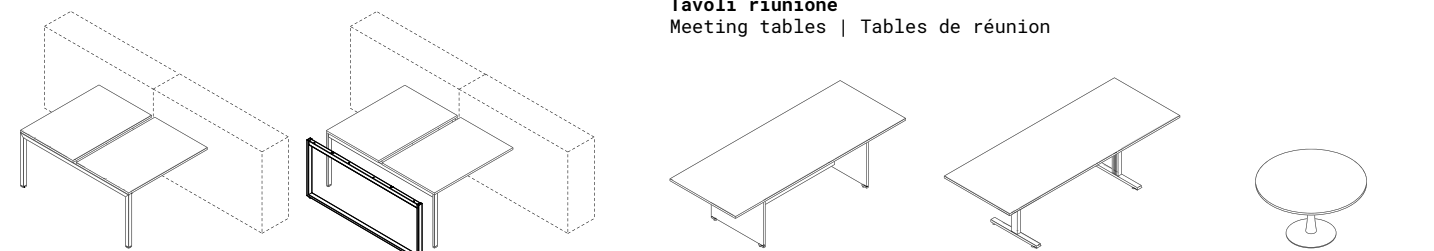

L 210 / 260
P 100
H 73,6

Ø 80 / 100 / 120
H 71,8

Comby Comby | Comby

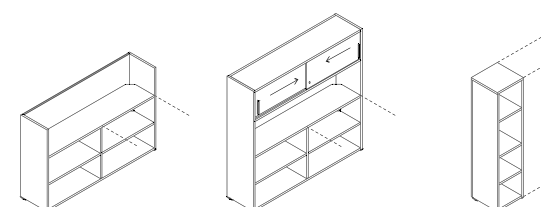

L 165
P 40
H1 109,3 / H2 160

L 40
P 40
H 160





Il bench si impone per la sua struttura compatta e leggera. La regolazione differenziata dei piani e il pannello divisorio fisso consentono una reale indipendenza tra postazioni di lavoro.

This bench stands out for its compact and light structure. The possibility to adjust the worktops and the partition screen allow total independence between workstations.

Le banc s'impose avec sa structure compacte et légère. Le réglage différencié des plateaux et l'écran fixe permettent une vraie indépendance entre les postes de travail.



←
Il tastierino elettronico permette la corretta regolazione e memorizzazione.
The electronic keypad allows precise adjustments and position storage.
Le clavier électronique permet le réglage correct et la mémorisation des positions.



Inquadra il QrCode e scopri le finiture disponibili

Scan the QrCode and discover the available finishes

Scannez le QR Code e découvrez les finitions disponibles



Scrivania con altezza regolabile

Desks with adjustable height | Bureaux avec hauteur réglable

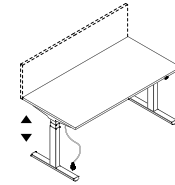

L 140 / 160 / 180
P 80
H 65▼ 130▲

Bench con altezza regolabile

Bench with adjustable height | Bench avec hauteur réglable

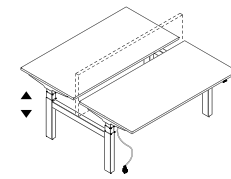

L 160 / 180
P 168,8
H 65▼ 130▲

Pannello frontale per bench

Front panel for bench | Panneau frontal pour bench

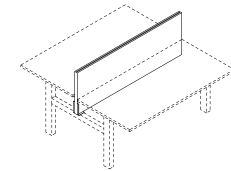

L 160 / 180
P 4
H 56

For/
Fil Rouge
5th Element
Oxi
Up
Seguo



cod. 643



cod. 642

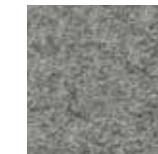

Schermo divisorio in legno con profilo superiore per aggancio accessori porta cancelleria. L'impiego di accessori fonoassorbenti con cuciture o tasche permette una significativa correzione acustica nella postazione.

Wooden partition screen with upper profile for hang stationery accessories. The use of sound-absorbing accessories with seams or pockets provides significant improvements in sound absorption at the workstation.

Écran en bois avec profil supérieur pour l'accrochage d'accessoires porte-papeterie. L'utilisation d'accessoires insonorisant avec coutures ou poches permet une correction acoustique importante au poste de travail.

cod. 609





cod. 595



cod. 598



**Schermo divisorio in legno
dotato di rivestimento
imbottito in tessuto a fasce
orizzontali.
Il profilo superiore consente
l'aggancio degli accessori
porta cancelleria a catalogo.**

Wooden partition screen
fitted with horizontal
upholstered fabric bands.
The upper profile allows the
attachment of any stationery
accessory included in the
catalogue.

Écran en bois avec
revêtement en tissu
rembourré à bandes
horizontales. Le profil
supérieur permet de fixer
les accessoires porte-
papeterie inclus dans le
catalogue.



For/
Fil Rouge
5th Element
Oxi
Up
Seguo

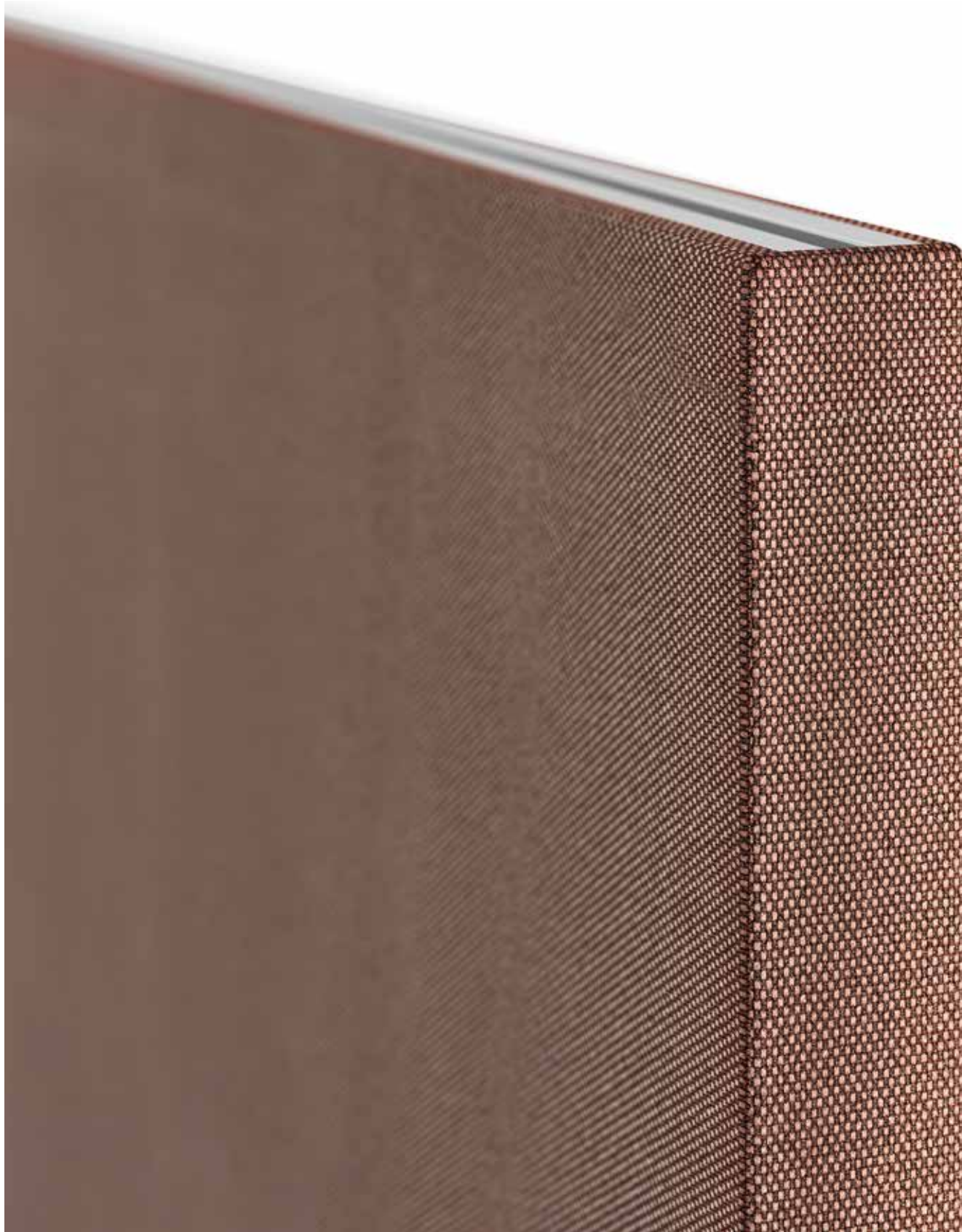

Schermo divisorio in legno rivestito in tessuto. Un sistema di separazione il cui valore è materico, estetico e funzionale grazie al profilo superiore di aggancio per accessori.

Wooden or fabric-finished partition screen. A separation system with high value in its materials, aesthetics and functionality thanks to its upper profile to hang accessories.

Écrans en bois revêtu en tissu. Un système de séparation dont la valeur est matérielle, esthétique et fonctionnelle, grâce au profil supérieur pour l'accrochage des accessoires.



cod. 750

cod. 605



For/
Fil Rouge
5th Element
Oxi
Up
Seguo

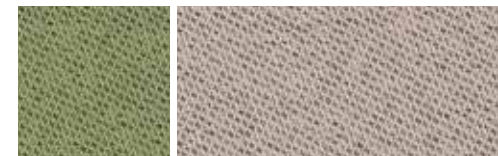

cod. 679

cod. 677

Un'idea compositiva che appare come somma di due schermi dai bordi arrotondati. I materiali impiegati rendono lo schermo fortemente fonoassorbente e quindi determinante in uffici in cui il comfort acustico è decisivo.

A compositional idea that appears as the sum of two panels with rounded edges. The selected materials increase the screen sound absorption and do make a difference in offices where acoustic comfort is crucial.

Une idée de composition qui apparait comme la somme de deux panneaux aux bords arrondis. Les matériaux utilisés augmentent l'insonorisation des panneaux ce qui fait la différence pour les bureaux où le confort acoustique est essentiel.



cod. 683



For/
Fil Rouge
5th Element
Oxi
Up
Seguo



cod. 604

cod. 595



Schermi stampati con tessuto integrato, compatti e altamente fonoassorbenti. La pulizia delle linee è rafforzata dai fissaggi a scomparsa.

Printed panels with integrated fabric, compact and highly sound absorbing. Neat outlines also thanks to the hidden fixtures.

Panneaux imprimés avec tissu intégré, compacts et fortement insonorisant. La définition des lignes est renforcée par les éléments de fixation cachés.

cod. 616



S05

SI design - CSR Las Mobili

For/
Fil Rouge
5th Element
Oxi
Up
Seguo



cod. 305



Schermi in feltro stampato, singoli o doppi, proposti in 4 colori.

Printed felt panels, single or double, available in 4 colours.

Panneaux en feutre imprimé, simples ou doubles, proposés en 4 couleurs.

cod. 300

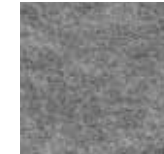

cod. 400



Inquadra il QrCode e scopri le finiture disponibili

Scan the QrCode and discover the available finishes

Scannez le QR Code e découvrez les finitions disponibles

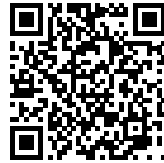

S1 - S2

Schermi frontali | Front panels | Panneaux frontaux

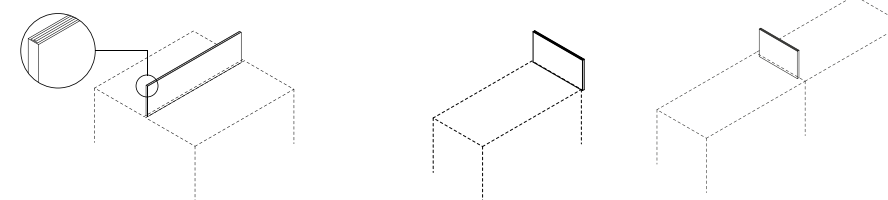

L 100 / 120 / 140 / 160 / 180
P 2,5
H 38,2

L 60 / 70 / 80
P 2,5
H 38,2

L 70
P 2,5
H 35,7

S3

Schermi frontali | Front panels | Panneaux frontaux

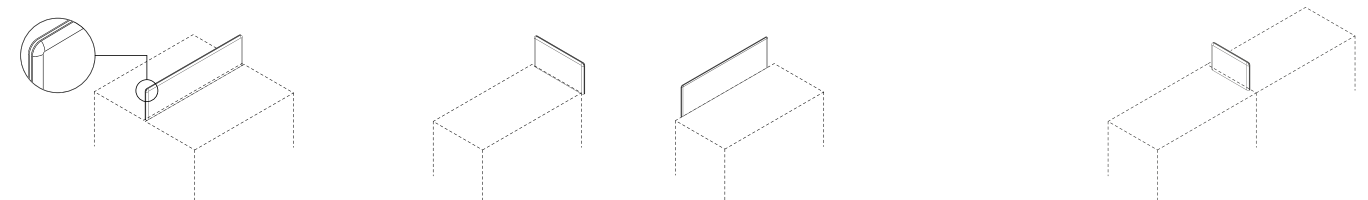

L 100 / 120 / 140 / 160 / 180
P 3,8
H 38,2

L 60 / 70 / 80
P 3,8
H 38,2

L 105,6 / 125,6 / 145,6 / 165,6
P 3,8
H 44

L 70
P 3,8
H 35,7

S4

Schermi frontali | Front panels | Panneaux frontaux

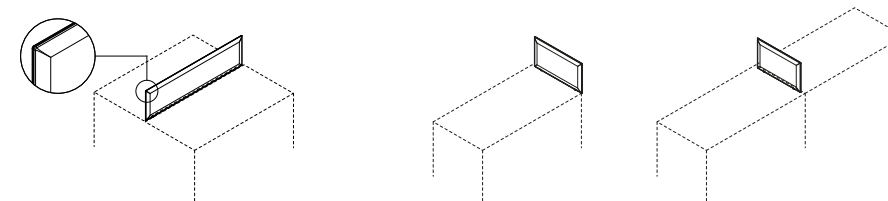

L 96 / 116 / 136 / 156 / 176
P 3
H 38,2

L 56 / 66 / 76
P 3
H 38,2

L 66
P 3
H 35,7

S5

Schermi frontali | Front panels | Panneaux frontaux

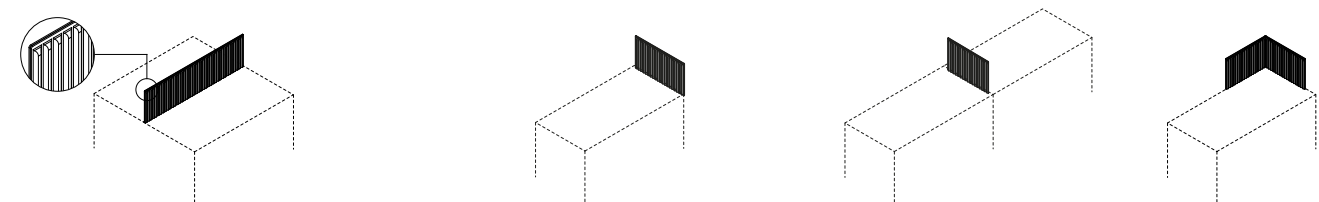

L 97,2 / 117,2 / 137,2 / 157,2 / 177,2
P 2,4
H 38,2

L 57,2 / 67,2 / 77,2
P 2,4
H 38,2

L 67,2
P 2,4
H 35,7

L 58,8
P 2,4
H 38,2

Schermi-schiena frontali

Front-modesty panels | Front-modesty panels

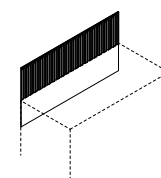

L 57,2 / 67,2 / 77,2 / 97,2 / 117,2 / 137,2 / 157,2 / 177,2
P 2,4
H 38,2 - 72

tavoli multifunzione
multipurpose tables
tables multifonction

FIL ROUGE 5th ELEMENT OXI
UP SCHERMI **PIEGO CHIUDO**
SEGUO SHARE CUBO PRONTO
CONTENITORI UNIVERSALI
JERA ENOSI E.O.S. IULIO
ELITE DELTA I-MEET NICE POINT
PAUSA CONVIVIO FUNGO
SEGNO ICARO REGOLO KYOTO
PODIO LEAD JERA SCENA NEO
CHAIR TRAMA ATHENA FORMEN
GALASSIA STAR SISTEMA CAST
CIAK PRIMA RASSEGNA ESSAI
HELLÒ OSCAR F01 F02 F03 F04
VEDETTE FICTION TROUPE
ZOOM SUPEROTTO PROVINO
F01 BENCH F03 BENCH REGIA
MOVIE TRUKA FESTIVAL JETSET
JERA22 TREND SET22 DOMUS
DRIVE IN DIVO FLAGS TRAILER
WORKLAND





Tavoli in varie finiture a libro, con piano ribaltabile o con gambe pieghevoli, pensati per ambienti polifunzionali in cui la riunione, la formazione o il lavoro di gruppo richiedono configurazioni facilmente modificabili e uno stoccaggio compatto e agevole.

Folding tables in various finishes, with folding top or folding legs, designed for multi-purpose environments where meetings, training or teamwork require easily modifiable configurations and compact and easy storage.

Tables avec différentes finitions pliants, plateau rabattable ou pieds pliants, conçus pour les environnements multi-fonction où les réunions, la formation ou le travail en groupe qui nécessitent des configurations facilement modifiables et un rangement compact et simple.



cod. 03

cod. 68



→ Tavoli ribaltabili con ruote con fermo a stoccaggio laterale.
Folding tables with castors and brake, for side storage.
Tables rabattables avec roues et blocage à rangement latérale.







←
Tre funzionalità
essenziali: gambe
pieghevoli, piani
ribaltabili e ruote
con fermo per cambiare
posizione e consentire
uno stoccaggio
agevole.

Three essential
functions: folding
legs, folding tops and
castors with brakes to
allow position changes
and easy storage.

Trois fonctions
essentielles :
pieds pliants,
plateaux rabattables
et roues avec blocage
pour le déplacement
et pour faciliter le
rangement.



cod.68



cod.NR 03

**Un sistema solido
caratterizzato da una
struttura in acciaio
stampato in due finiture.**

**Un système solide
caractérisé par une structure
en acier imprimé en deux
finitions.**

A solid system characterised
by a moulded steel frame in
two finishes.



Seguo



Il sistema di regolazione dell'altezza del piano consente di effettuare riunioni seduti o in piedi. La postura è variabile, garantendo un effettivo benessere fisico. Il meccanismo manuale consente, inoltre, una collocazione libera e indipendente dall'energia elettrica.

The worktop height-adjustment system allows you to hold your meeting seated or standing. The user posture is non static, ensuring higher physical wellness. The manual mechanism makes you free and not dependant on electric power.

Le système de réglage de la hauteur du plateau permet de faire des réunions assises ou debout. La posture est variable, garantissant un meilleur bien-être physique. Le mécanisme manuel permet également de choisir une position libre et indépendante de l'électricité.



← Tavolo riunioni in colore nero e con piano quadrato da 120 cm.

Black meeting tables with 120-cm square worktop.

Table de réunion en noir avec plateau carré de 120 cm.



cod. 59





cod. 59

La mobilità, l'elevazione e la facilità di rangement sono delle esigenze fondamentali per la flessibilità degli spazi. Il meccanismo d'elevazione manuale, senza motore e indipendente dall'elettricità, permette una totale libertà di posizionamento della tavola di riunione e della tavola dei relatori.

Mobilità, elevazione e facilità di stoccaggio sono requisiti irrinunciabili per spazi flessibili. Il meccanismo ad elevazione manuale, senza motore e indipendente da punti di prese elettriche, permette totale libertà di posizionamento dal tavolo riunioni a quello relatore.

Flexibility, elevation and ease of storage are essential in flexible spaces. The manual elevation mechanism, without motor and independent from electrical power sockets, gives total freedom in choosing the layout of meeting tables and speakers' tables.

→
Tavolo relatore con basamento con ruote e piano ribaltabile.
Speakers' table with base on castors and folding top.
Table de l'orateur avec base sur roues et plateau rabattable.



Inquadra il QrCode e scopri le finiture disponibili

Scan the QrCode and discover the available finishes

Scannez le QR Code e découvrez les finitions disponibles

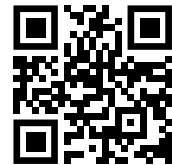

Piego



Chiudo

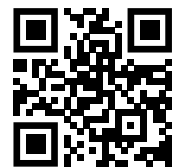

Seguo

Piego
Tavoli | Tables | Tables

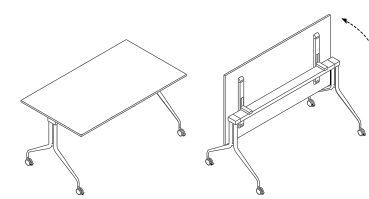

L 140 / 160 / 180
P 80
H 72,8

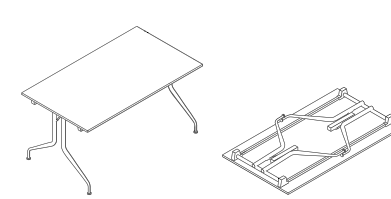

L 140 / 160 / 180
P 80
H 72,8

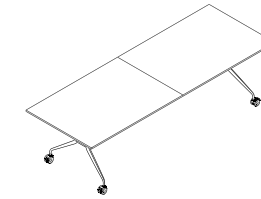

L 200 / 240
P 100
H 72,8

Chiudo
Tavoli | Tables | Tables

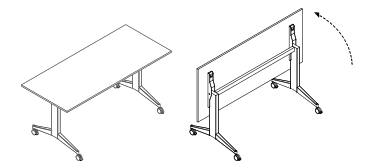

L 140 / 160 / 180
P 70
H 73,5

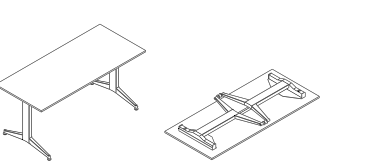

L 140 / 160 / 180
P 70
H 73,5

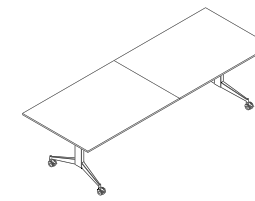

L 280 / 320
P 100
H 73,5

Seguo
Tavoli | Tables | Tables

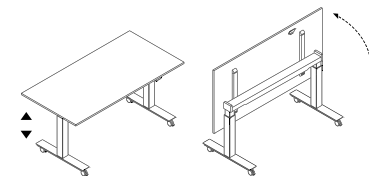

L 140 / 160 / 180
P 80
H 71,8▼ 111,8▲

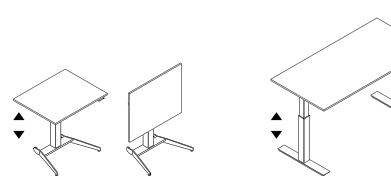

L 80
P 65
H 71,8▼ 109,8▲

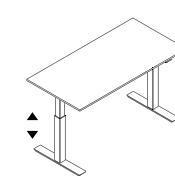

L 160 / 180
P 80
H 67,8▼ 117,8▲

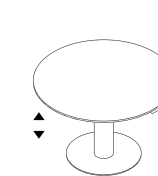

Ø 150
H 67,8▼ 117,8▲

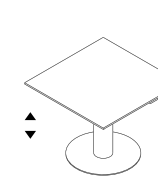

L 120
P 120
H 67,8▼ 117,8▲

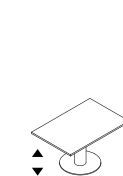

L 90
P 60
H 47,5▼ 73,5▲

FIL ROUGE 5th ELEMENT OXI
UP SCHERMI PIEGO CHIUDO
SEGUO **SHARE CUBO PRONTO**
CONTENITORI UNIVERSALI
JERA ENOSI E.O.S. IULIO
ELITE DELTA I-MEET NICE POINT
PAUSA CONVIVIO FUNGO
SEGNO ICARO REGOLO KYOTO
PODIO LEAD JERA SCENA NEO
CHAIR TRAMA ATHENA FORMEN
GALASSIA STAR SISTEMA CAST
CIAK PRIMA RASSEGNA ESSAI
HELLÒ OSCAR F01 F02 F03 F04
VEDETTE FICTION TROUPE
ZOOM SUPEROTTO PROVINO
F01 BENCH F03 BENCH REGIA
MOVIE TRUKA FESTIVAL JETSET
JERA22 TREND SET22 DOMUS
DRIVE IN DIVO FLAGS TRAILER
WORKLAND



Le soluzioni Share sono ideali per arredare open space creando zone differenziate e flessibili. Possono integrarsi, anche singolarmente, in uffici già arredati o in uffici tradizionali, grazie ad un design essenziale ed estremamente funzionale.

Share solutions are ideal for furnishing open spaces by creating differentiated and flexible zones. Thanks to their simple and extremely functional design, they can also be integrated individually into already furnished offices or traditional workspaces.

Les solutions Share sont parfaites pour meubler des open spaces et créer des zones individualisées et souples. Grâce à un design essentiel et extrêmement fonctionnel, elles peuvent s'intégrer, également dans des bureaux déjà meublés ou dans des bureaux traditionnels.

cod. C05

cod. 44

cod. Bi 02



cod. 68

cod. Nr 03

cod. 46

cod. 684



Inquadra il QrCode e scopri le finiture disponibili

Scan the QrCode and discover the available finishes

Scannez le QR Code e découvrez les finitions disponibles



Tavoli
Tables | Tables

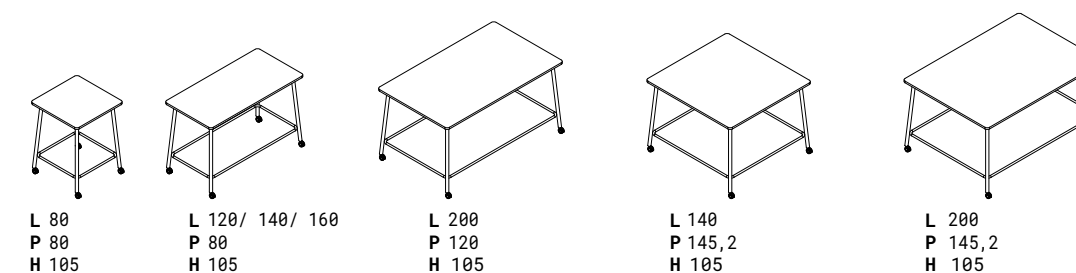
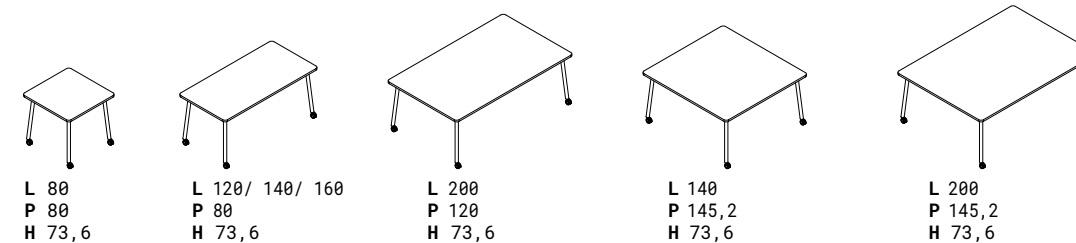

Media Station

Lavagne
Whiteboard | Tableaux

Divisori fonoassorbenti
Sound-proofing dividing panels | Cloison acoustiques

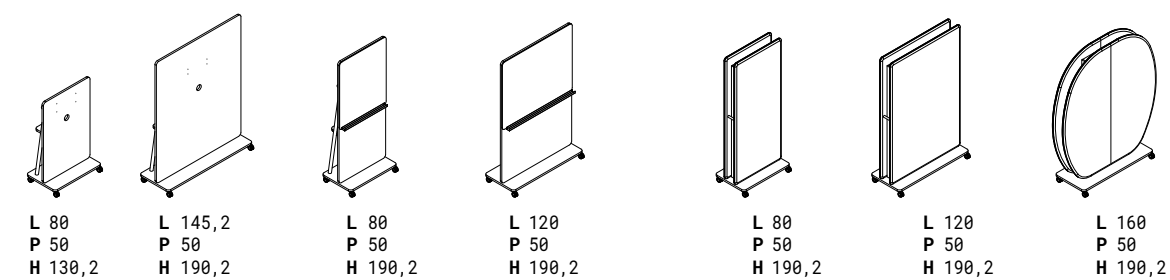

Librerie
Bookshelves | Bibliothèques

Appendiabiti
Stand clothes-hanger | Cintre

Fioriere
Planter box | Bac a fleurs

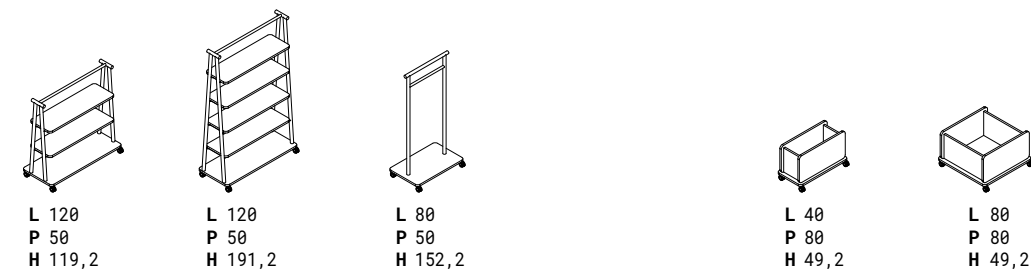

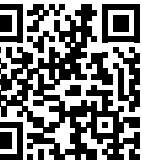

Una libreria leggera, semplice, essenziale che assume unicità e personalità grazie ai colori, coordinati e combinabili, della sua struttura metallica e dei suoi contenitori e ripiani in legno.

A light, simple bookcase that takes on uniqueness and personality thanks to the combinable colour tones of its metal structure and its cases and shelves.

Une bibliothèque légère, simple, essentielle d'une grande singularité et personnalité grâce aux couleurs, coordonnées et combinables, de sa structure métallique et de ses boîtes et étagères en bois.

cod. Sg 01 cod. 46 cod. Bi 02 cod. Cp 01

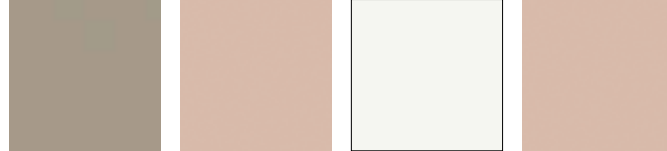

cod. 39



cod. 20



cod. 59



cod. NR 03



Inquadra il QrCode e scopri le finiture disponibili

Scan the QrCode and discover the available finishes

Scannez le QR Code e découvrez les finitions disponibles

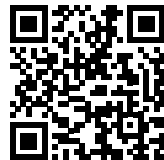

Montanti Uprights | Montants

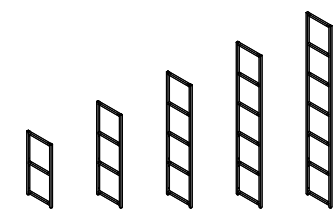

L 2,5
P 36,6
H 82,1/120,5/158,9/197,3/235,7

Pannello strutturale Structural panel | Panneau structurel



L 80
P 36,2
H 2,5

Mobili bassi e top di finitura Low cabinets and finish top | Meubles bas et top de finition

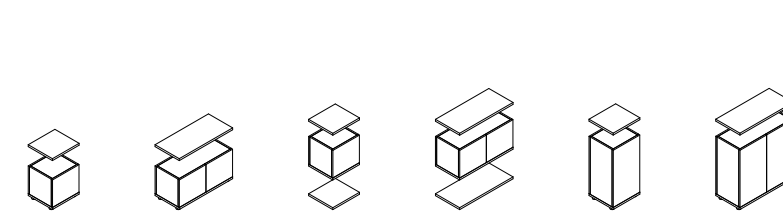

L 40 P 36,2 H 43,6
L 80 P 36,2 H 43,6
L 40 P 36,2 H 82
L 80 P 36,2 H 82
L 40 P 36,2 H 82
L 80 P 36,2 H 82

Lavagne Whiteboard | Tableaux

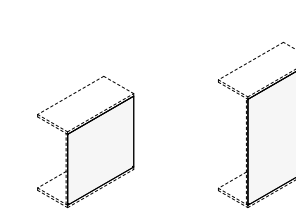

L 40/80 P 0,1 H 74
L 40/80 P 0,1 H 112,4

Elementi di supporto scrivanie Desk support elements | Éléments de support de bureau

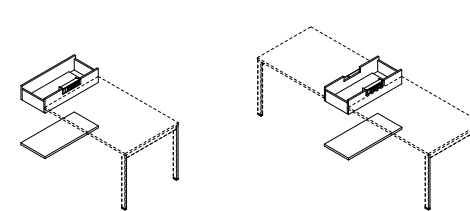

L 79,7 P 36 H 18
L 79,7 P 36 H 18

Scrivanie Desks | Bureaux

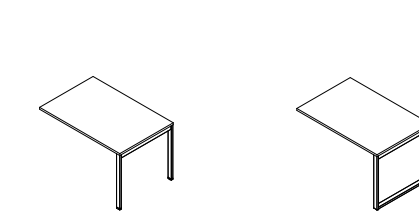

L 100/120/140/160/180 P 80 H 73,6
L 100/120/140/160/180 P 80 H 73,6

Nicchie, mensole e fianco estetico Niches, shelves and aesthetic panel | Meubles bas et top de finition

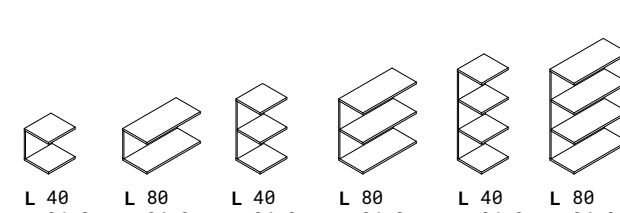

L 40 P 36,2 H 40,9
L 80 P 36,2 H 40,9
L 40 P 36,2 H 79,3
L 80 P 36,2 H 79,3
L 40 P 36,2 H 117,7
L 80 P 36,2 H 117,7

Mensole Shelves | Etageres

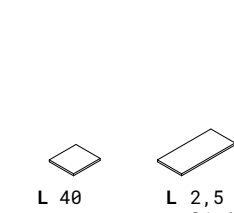

L 2,5 P 31,5 H 35,7
L 40 P 36,2 H 2,5
L 2,5 P 31,6 H 35,8

Lockers

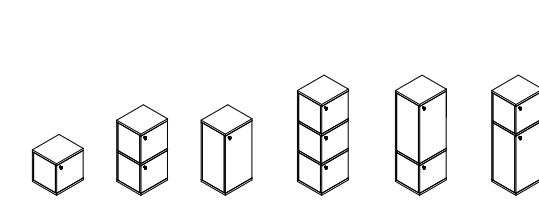

L 40 P 36,2 H 40,9
L 40 P 36,2 H 79,3
L 40 P 36,2 H 79,3
L 40 P 36,2 H 117,7
L 40 P 36,2 H 117,7
L 40 P 36,2 H 117,7

Accessori Accessories | Accessoires

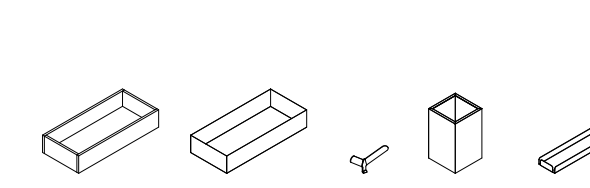

L 40/80 P 36 H 15
L 40/80 P 36 H 15
L 23 P 6 H 16
L 20 P 20 H 32/50
L 20 P 6 H 2





La semplicità formale di Pronto viene attutita dai cromatismi dei pannelli esterni, disponibili in vari e accattivanti colori e finiture, e dei rivestimenti interni in tessuto. La cabina prevede la possibilità di avere il lato opposto a quello della porta anch'esso in vetro. Il sistema costruttivo garantisce un buon isolamento acustico dall'esterno e dall'interno.

The formal simplicity of Pronto is softened by the colour schemes of the outer panels, available in a variety of attractive tones and finishes, and the inner upholstery. There is also the option of having the side opposite the cabin door also be in glass. The construction system ensures good sound insulation from inside and outside.

La simplicité formelle de Pronto est atténuée par les chromatismes des panneaux externes, disponibles dans différentes couleurs et finitions captivantes et des revêtements internes en tissu. La cabine prévoit la possibilité d'avoir le côté opposé à celui de la porte en verre lui aussi. Le système de construction garantit une bonne isolation sonore de l'extérieur et de l'intérieur.

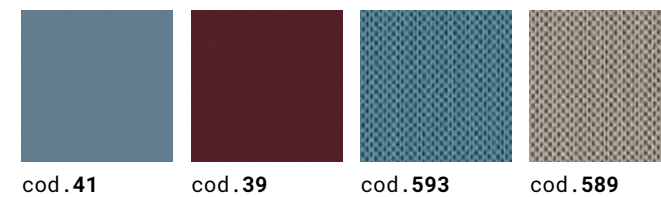

cod. 41

cod. 39

cod. 593

cod. 589

Inquadra il QrCode e scopri le finiture disponibili

Scan the QrCode and discover the available finishes

Scannez le QR Code e découvrez les finitions disponibles

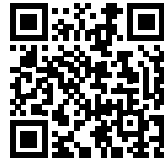

Phone booths

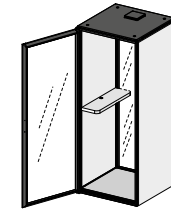

L 97
P 97
H 235,3

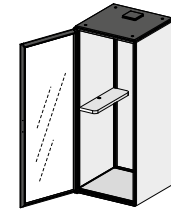

L 97
P 97
H 235,3

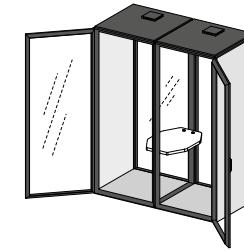

L 190
P 97
H 235,3

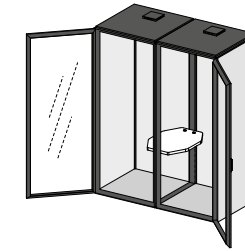

L 190
P 97
H 235,3

FIL ROUGE 5th ELEMENT OXI
UP SCHERMI PIEGO CHIUDO
SEGUO SHARE CUBO PRONTO

CONTENITORI UNIVERSALI

JERA ENOSI E.O.S. IULIO
ELITE DELTA I-MEET NICE POINT
PAUSA CONVIVIO FUNGO
SEGNO ICARO REGOLO KYOTO
PODIO LEAD JERA SCENA NEO
CHAIR TRAMA ATHENA FORMEN
GALASSIA STAR SISTEMA CAST
CIAK PRIMA RASSEGNA ESSAI
HELLÒ OSCAR F01 F02 F03 F04
VEDETTE FICTION TROUPE
ZOOM SUPEROTTO PROVINO
F01 BENCH F03 BENCH REGIA
MOVIE TRUKA FESTIVAL JETSET
JERA22 TREND SET22 DOMUS
DRIVE IN DIVO FLAGS TRAILER
WORKLAND

Contenitori Universali

CSR Las Mobili
Smart cabinets Paolo Pampanoni



Elementi studiati per conservare piccoli oggetti di uso corrente, in continuo movimento nello spazio operativo fino a diventare vere e proprie sedute. Cassettiere in numerose varianti funzionali ed estetiche cui spetta il ruolo di caratterizzare l'intera postazione.

Elements designed for storing small objects of everyday use, constantly being moved throughout the working area and ready to become handy seats. Drawers in different functional and aesthetic options, to characterise the entire workstation.

Éléments conçus pour ranger de petits objets d'usage quotidien, en mouvement continu dans toute la zone de travail pour devenir de véritables chaises. Tiroirs dans de nombreuses variantes fonctionnelles et esthétiques dont le rôle est de caractériser l'ensemble du poste de travail.

cod. 68

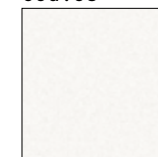

cod. 03

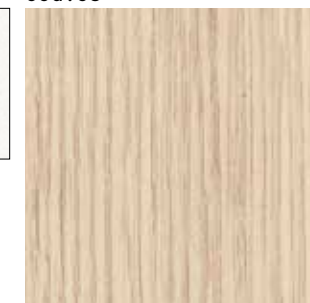

I contenitori Smart nascono dalla volontà di attrezzare le postazioni in modo libero e funzionale rispettando le più varie esigenze del cliente. La stretta modularità e la variabilità tipologica consentono di ottenere composizioni articolate e complete.

Smart storage units are the response to the need for freely and functionally equipped workstations that can meet any need. The high modularity and the many typologies allow the creation of complex and complete layouts.

Les rangements « Smart » sont le résultat de la volonté d'équiper les postes de travail de manière libre et fonctionnelle en respectant les besoins les plus divers des clients. La précision de la modularité et la variabilité des typologies permettent d'obtenir des compositions articulées et complètes.

cod. 07



cod. 68



cod. 38



cod. NR 03





cod.CP 01



cod.NR 03



Contenitori in cui si alternano vani a giorno e ante in metallo microforate, elementi adeguati ad ogni ambiente, operativo o direzionale.

Storage units that alternate open shelves and cabinets with micro-perforated metal doors that can suit any environment, operational or executive.

Rangements qui alternent les compartiments ouverts et les portes en métal micro-perforées, éléments adaptés à n'importe quel environnement, opérationnel ou exécutif.



Il telaio in colore nero e la piccola maniglia a ponte evidenziano le alternanze delle ante vetrate e di quelle in legno, secondo schemi compositivi pensati per elevare il livello estetico del contenitore. La cornice, netta e decisa, valorizza ogni elemento dando un carattere nuovo.

Le cadre noir et la petite poignée à pont soulignent l'alternance des portes en verre et en bois, selon des schémas de composition conçus pour augmenter le niveau esthétique du rangement. Les lignes claires et décisives mettent en valeur chaque élément en lui donnant un nouveau caractère.

The black frame and the small bridge-shaped handle enhance the alternation of glass and wooden doors, following composition schemes designed to improve the storage unit aesthetic level. The clear and neat frame enhances each individual element giving it a new personality.

→
Basamento
metallico per
contenitori
bassi, medi e
alti.
Metal base for
low, medium-
height and high
containers.
Base en métal
pour meubles bas,
moyens et hauts.



storage units

rangement



cod. 68

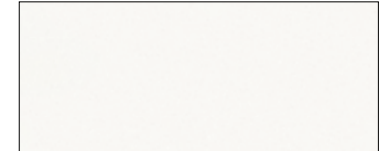

Librerie a spalla portante ideali per l'archiviazione massiva o per realizzare giochi di pieni e di vuoti in cui libri, riviste e oggetti si alternano scenograficamente. Contenuti estetici e culturali si avvicendano per arredare archivi, sale riunioni o spazi di rappresentanza.

Free-standing bookcases perfect for filing or to play with empty and full volumes where books magazines and objects alternate scenographically. Aesthetic and cultural content communicate to furnish filing rooms, meeting rooms or representative spaces.

Bibliothèques autoportées idéales pour un archivage important ou pour créer des jeux de pleins et de vides où les livres, les magazines et les objets s'alternent scénographiquement. Les contenus esthétiques et culturels communiquent pour meubler des archives, des salles de réunion ou des espaces représentatifs.

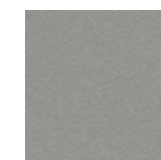

cod. 38

→
Bussolotti a
giorno o con
ante proposti in
quattro finiture.
Open square
shelves or with
doors available
in four finishes.
Étagères ouvertes
ou avec portes
disponibles en
quatre finitions.



Lockers



L'ufficio agile si struttura per accogliere un'operatività dinamica e in continua comunicazione tra esterno e interno. I contenitori guardaroba, in cui conservare effetti personali o capi d'abbigliamento, si integrano pienamente nello spazio operativo.

The agile office is organised to welcome dynamic operations in constant communication between the outside and inside environments. Wardrobe containers for the storage of personal belongings or clothing are fully integrated into the operational space.

Le bureau agile est structuré pour permettre des opérations dynamiques avec communication continue entre l'extérieur et l'intérieur. Les rangements armoire, dans lesquels ranger les effets personnels ou les vêtements, sont entièrement intégrés dans l'espace opérationnel.



← Anta con serratura elettronica, scheda master e chiave di sicurezza.

Doors with electronic lock, master card and safety key.

Porte avec serrure électronique, carte master et clé de sécurité.



Inquadra il QrCode e scopri le finiture disponibili

Scan the QrCode and discover the available finishes

Scannez le QR Code e découvrez les finitions disponibles



Mobili su ruote

Cabinets on wheels | Caissons sur roule

*3/



L 42,1
P 55,2
H 57,3



L 65
P 55
H 47



L 65
P 55
H 62



L 67,7
P 55,1
H 56,8

Mobili di servizio su piedini

Service units on feet | Porte-photocopieur et meubles de service

sx/dx

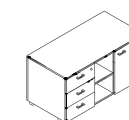

L 120
P 52,5
H 61,5

sx/dx

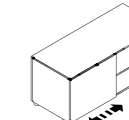

L 140
P 60
H 61,5

Mobili

Cabinets | Meubles

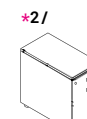

L 42
P 80
H1 71 / H2 109,3

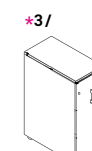

L 45
P 80
H1 71 / H2 109,3

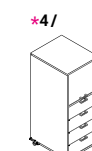

L 45
P 53,2
H 113,6

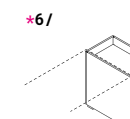

L 41,8
P 70 / 80
H 71,1



L 70
P 41,7
H1 71,1 / H2 109,3

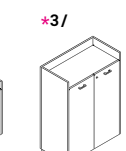

L 70
P 41,7
H1 71,1 / H2 109,3

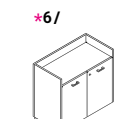

L 80
P 41,7
H1 71,1 / H2 109,3

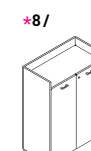

L 80
P 41,7
H1 71,1 / H2 109,3

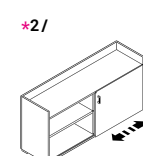

L 145 / 165
P 41,7
H1 71,1 / H2 109,3

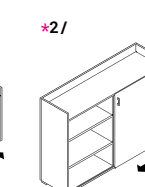

L 145 / 165
P 41,7
H1 71,1 / H2 109,3

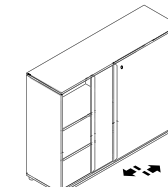

L 180,5
P 49,1
H1 121,6 / H2 198,5

Contenitori

Cabinets | Meubles

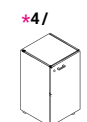

L 45
P 46,3
H1 81,5 / H2 119,8 / H3 158,3 / H4 196,7 / H5 235 / H6 260

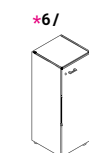

L 45
P 46,3
H1 81,5 / H2 119,8 / H3 158,3 / H4 196,7 / H5 235 / H6 260



L 45
P 46,3
H1 81,5 / H2 119,8 / H3 158,3 / H4 196,7 / H5 235 / H6 260

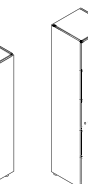

L 45
P 46,3
H1 81,5 / H2 119,8 / H3 158,3 / H4 196,7 / H5 235 / H6 260



L 45
P 46,3
H1 81,5 / H2 119,8 / H3 158,3 / H4 196,7 / H5 235 / H6 260



L 45
P 46,3
H1 81,5 / H2 119,8 / H3 158,3 / H4 196,7 / H5 235 / H6 260

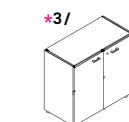

L 90
P 46,3
H1 81,5 / H2 119,8 / H3 158,3 / H4 196,7 / H5 235 / H6 260

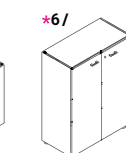

L 90
P 46,3
H1 81,5 / H2 119,8 / H3 158,3 / H4 196,7 / H5 235 / H6 260

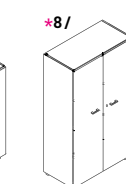

L 90
P 46,3
H1 81,5 / H2 119,8 / H3 158,3 / H4 196,7 / H5 235 / H6 260

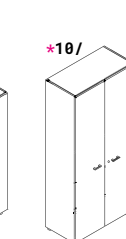

L 90
P 46,3
H1 81,5 / H2 119,8 / H3 158,3 / H4 196,7 / H5 235 / H6 260

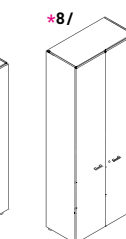

L 90
P 46,3
H1 81,5 / H2 119,8 / H3 158,3 / H4 196,7 / H5 235 / H6 260

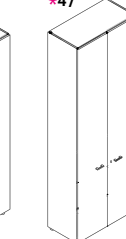

L 90
P 46,3
H1 81,5 / H2 119,8 / H3 158,3 / H4 196,7 / H5 235 / H6 260

Lockers

Lockers | Lockers



L 45
P 44,5
H1 43 / H2 81,5 / H3 119,8 / H4 158,3

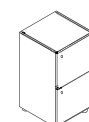

L 45
P 44,5
H1 43 / H2 81,5 / H3 119,8 / H4 158,3

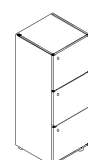

L 45
P 44,5
H1 43 / H2 81,5 / H3 119,8 / H4 158,3

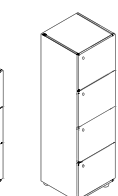

L 45
P 44,5
H1 43 / H2 81,5 / H3 119,8 / H4 158,3

* configurazioni possibili | possible configurations | possibles configurations

FIL ROUGE 5th ELEMENT OXI
UP SCHERMI PIEGO CHIUDO
SEGUO SHARE CUBO PRONTO
CONTENITORI UNIVERSALI
JERA ENOSI E.O.S. IULIO
ELITE DELTA I-MEET NICE POINT
PAUSA CONVIVIO FUNGO
SEGNO ICARO REGOLO KYOTO
PODIO LEAD JERA SCENA NEO
CHAIR TRAMA ATHENA FORMEN
GALASSIA STAR SISTEMA CAST
CIAK PRIMA RASSEGNA ESSAI
HELLÒ OSCAR F01 F02 F03 F04
VEDETTE FICTION TROUPE
ZOOM SUPEROTTO PROVINO
F01 BENCH F03 BENCH REGIA
MOVIE TRUKA FESTIVAL JETSET
JERA22 TREND SET22 DOMUS
DRIVE IN DIVO FLAGS TRAILER
WORKLAND



Legno e pelle caratterizzano in modo diverso i pannelli strutturali da quelli delle superfici di lavoro. Un effetto estetico e tattile prezioso e ricercato.

Wood and leather characterise the structural elements, creating a clear distinction from the working surfaces. An aesthetic and tactile effect, precious and sophisticated.

Le bois et le cuir caractérisent les panneaux structuraux différemment de ceux qui composent les surfaces de travail. Un effet esthétique et tactile précieux et sophistiqué.



↑
Superfici orizzontali per il lavoro e verticali per lo stoccaggio.
Horizontal surfaces for work and vertical volumes that provide storage space.
Surface horizontales pour le travail et verticales pour le rangement.



←
Un incastro perfetto tra piano e gamba, tra materiali diversi.
A perfect integration of leg and worktop, between different materials.
Une combinaison parfaite entre les pieds et le plateau, entre matériaux différents.

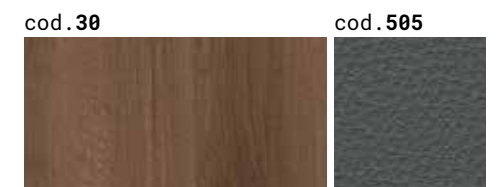



←
L'elettificazione avviene attraverso un funzionale modulo di cablaggio.
Electric connections run through a functional wiring module.
L'électrification est prévue avec un module de câblage fonctionnel.

Un elegante connessione tra fianco e piano, un avvicendamento attentamente studiato per esaltare le variazioni di finitura, le differenze tattili tra legno e pelle.

Une connexion élégante entre le côté et le plateau, un combinaison soigneusement étudiée pour souligner les finitions, les différences tactiles entre le bois et le cuir.

An elegant connection between the side and the top, a careful combination designed to intensify tactile differences in wood and leather finishes.



I contenitori a parete introducono un modo nuovo di prevedere lo stoccaggio di documenti o oggetti personali, creando un'interessante alternanza di vuoti e pieni.

Wall cabinets introduce a new way of providing for the storage of documents or personal belongings and create an interesting alternation of empty and full volumes.

Les rangements à parois introduisent une nouvelle approche au stockage de documents ou d'objets personnels, créant une alternance intéressante de vide et de plein.



cod . 52



cod . 44





I mobili totem esaltano la collezione fondata sul valore delle grandi superfici e sulla loro essenzialità. Il pannello verticale, con la sua semplicità e purezza, nasconde il contenuto. Le linee verticali di strip led esaltano il gioco volumetrico dei totem in cui i pannelli frontali coprono interamente i moduli di contenimento. La luce esalta la tridimensionalità e migliora la fruibilità.

Totem units enhance the collection and its large surfaces and essential lines. The vertical panel, simple and neat, hides its content. The vertical LED strips amplify the totem volumes where the front panels completely cover the storage modules. Light itself emphasises three-dimension volumes and improves usability.

Les meubles totem enrichissent la collection basée sur la valeur des grandes surfaces et de leur essentialisme. Le panneau vertical, avec sa simplicité et sa pureté, cache le contenu. Les bandes de LED verticales soulignent le jeu des volumes des totems où les panneaux antérieurs couvrent complètement les modules de rangement. La lumière augmente le jeu tridimensionnel et facilite l'utilisation.



cod. 44



cod. 504



Le tonalità chiare e calde affermano la logica di modernità che ha ispirato il progetto. Ambienti austeri e istituzionali mutano, imponendosi per la loro modernità e raffinatezza.

Warm and light shades express the modern logical approach that has inspired this design. Austere and institutional settings are changing and impose their sense of modernity and elegance.

Les nuances claires et chaudes communiquent la logique de modernité qui a inspiré le projet. Les atmosphères austères et institutionnelles changent, s'imposant avec leur modernité et leur élégance.

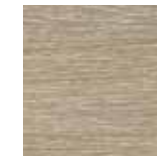

cod. 12

Una composizione articolata in cui spessori, superfici e materiali dialogano con grande equilibrio. Le forme innovative esprimono una reale evoluzione della postazione direzionale.

An articulated composition where thicknesses, surfaces and materials interact with great balance. These innovative shapes are a sign of true evolution in executive workstations.

Une composition articulée dans laquelle épaisseurs, surfaces et matériaux interagissent avec un grand équilibre. Ces nouvelles formes expriment une vraie évolution des postes de direction.



direzionali

executive

direction



→ Il tavolo da caffè riduce le proporzioni del grande tavolo riunioni.

The coffee table scales down the proportions of the large meeting table.

La table basse réduit les proportions de la grande table de réunion.

Inquadra il QrCode e scopri le finiture disponibili

Scan the QrCode and discover the available finishes

Scannez le QR Code e découvrez les finitions disponibles

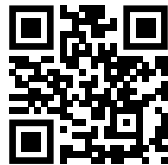

Scrivanie direzionali Executive desks | Bureaux de direction

sx/dx

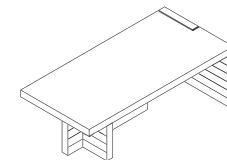

L 185 / 210 / 240
P 105
H 76

sx/dx

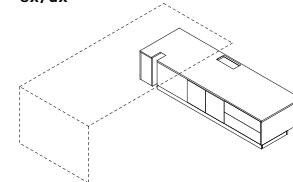

L 198
P 60
H 76

sx/dx

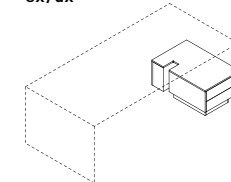

L 90
P 60
H 44

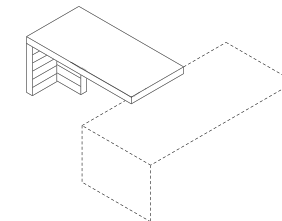

L 160
P 80
H 76

Tavoli da salotto e riunione Coffee and meeting tables | Tables de salon et de réunion

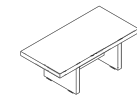

LxP 80 x 80
LxP 120 x 60
H 40

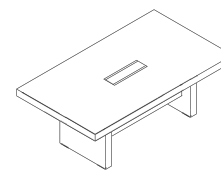

LxP 210 x 120
LxP 280 x 120
H 76

Contenitori totem Totem cabinets | Meubles Totem

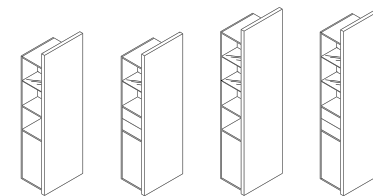

L 70
P 48,5
H1 223,4 / H2 261,8

Mobili sospesi e spalla verticale Suspended cabinets and vertical panel | Meubles suspendus et panneau vertical

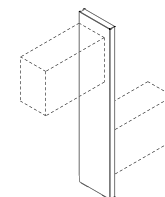

L 50
P 9
H 220



L 45
P 40
H 62,7

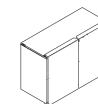

L 90
P 40
H 62,7





Una postazione integrata in cui la scrivania poggia stabilmente sul contenitore di servizio.

An integrated workstation where the desk rests firmly on the service unit.

Un poste de travail intégré où le bureau repose de manière stable sur le meuble de service.

cod. 56



cod. 68

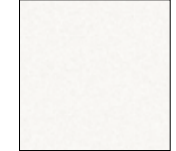

cod. 37



Enosi si impone per le sue forme moderne, sempre attuali e perfettamente abbinabili in ambienti classici e moderni. La scelta del bianco integrale crea luminosità e leggerezza.

Enosi stands out for its modern shapes, always trendy and perfectly combinable in classic and modern environments. Total white creates brightness and lightness.

Enosi s'impose avec ses formes modernes, toujours actuelles et parfaitement combinables dans des environnements classiques et modernes. Le choix du blanc intégral donne luminosité et légèreté.

→
Piano in finitura
Noce Pacific e
struttura con gambe
cromo.
Worktop in Pacific
Walnut finish and
frame with chrome
legs.
Plateau en finition
noyer Pacific et
structure avec pieds
chromés.





cod. 37



cod. BI 02



La sala riunioni unisce perfettamente al rigore formale dei piani e dei contenitori la morbidezza delle gambe e dei piedini. L'unione degli opposti crea un'atmosfera unica.

The meeting room perfectly integrates the formal rigour of tops and storage units with the softness of the legs and the feet. The union of opposites creates a unique atmosphere.

La salle de réunion combine parfaitement la rigueur formelle des plateaux et des rangements avec la douceur des jambes et des pieds. La rencontre des contraires crée une atmosphère unique.

→ Elemento centrale di risalita cavi con pannelli removibili.
Central cable route element with movable panels.
Élément central de remontée de câbles avec panneaux amovibles.





Il piano in vetro temperato evolve ulteriormente l'estetica della scrivania. La lucentezza della superficie si abbina correttamente sia con la gamba cromo che con la versione verniciata.

The tempered glass top marks a further evolution in the aesthetics of the desk. The surface brightness perfectly matches with both chrome-finished and painted legs.

Le plateau en verre trempé communique l'évolution esthétique du bureau. La luminosité de la surface s'harmonise bien avec le pied chromé et avec la version peinte.



direzionali

executive

direction



Enosi arricchisce ogni sala riunioni ponendosi come punto di riferimento formale dell'ambiente con semplicità e leggerezza. Un oggetto di elevato design per spazi di grande valore.

Enosi adds value to every meeting room by becoming a formal reference point for the environment, with simplicity and lightness. A high-design object for high-value spaces.

Enosi enrichit la salle de réunion en se proposant comme un point de référence formel de l'environnement, avec simplicité et légèreté. Un objet de haut design pour des espaces de grande valeur.

→ Tavolo circolare con diametro 120 cm.
Circular table with a diameter of 120 cm.
Table circulaire avec diamètre de 120 cm.



cod. CR 01



cod. 78

Inquadra il QrCode e scopri le finiture disponibili

Scan the QrCode and discover the available finishes

Scannez le QR Code e découvrez les finitions disponibles

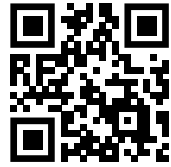

Scrivanie direzionali Executive desks | Bureaux de direction

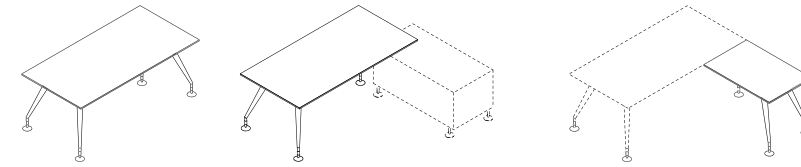

L 180 / 200 / 220
P 90
H 74

L 100
P 65
H 74

Tavoli riunione Meeting tables | Tables de réunion

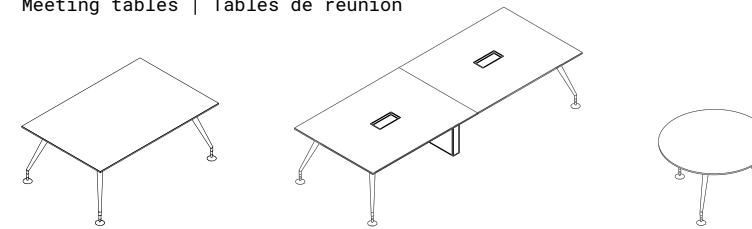

L 200
P 120
H 74

L 280 / 320 / 380
P 120
H 74

Ø 120
H 74

Cassettiere e mobili di servizio Pedestals and service units | Caissons et meubles de service

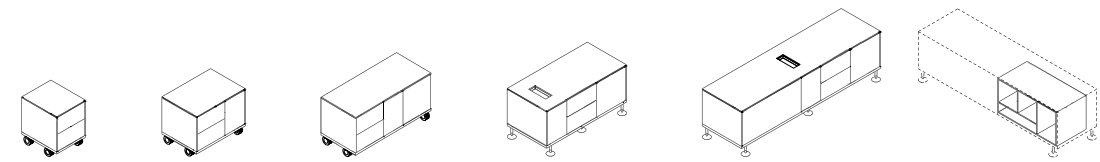

L 44,2
P 53,1
H 59,7

L 75
P 53,1
H 59,7

L 116
P 53,1
H 59,7

L 122,5
P 60
H 59,7

L 212,3
P 60
H 59,7

vista posteriore /
back view / vue de dos

Elementi componibili Modular units | Meubles modulaires

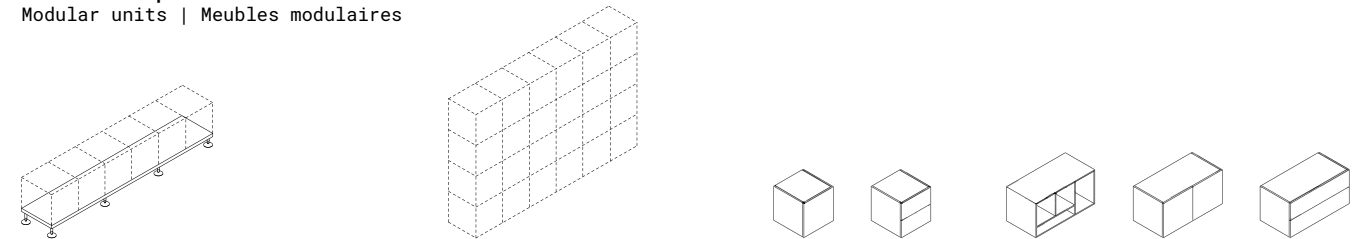

L 92,7 / 182,6 / 227,5 / 272,4
P 46,8
H 14

P 46,8
H 45 / 90 / 135 / 180

L 45
P 46,3
H 45

L 90
P 46,3
H 45





La collezione evolve con l'abbinamento di materiali diversi, legno e vetro, in un gioco di superfici lucide e di forme materiche. Il piano diventa elemento di grande distinzione.

This collection evolves through the combination of different materials, wood and glass, in a game of shiny surfaces and material volumes. The top becomes an element of great distinction.

La collection évolue avec l'association de différents matériaux, bois et verre, dans un jeu de surfaces polies et de formes matérielles. Le plateau devient un élément de grande distinction.



→ Tavolo riunioni quadrato con basamento centrale.
Square meeting table with central base.
Table de réunion carré avec base centrale.

cod. 13



Il tavolo riunioni si ispira alle linee estetiche della scrivania direzionale, sintetizzandone i tratti. Il piano mantiene la cifra perimetrale nero.

The meeting table is inspired by the executive desk aesthetic lines that highlight its features. The worktop maintains its distinctive line thanks to its black perimeter profile.

La table de réunion s'inspire aux lignes esthétiques du bureau de direction, reprenant ses caractéristiques. Le plateau maintient le trait distinctif du profil périmétrique noir.



Inquadra il QrCode e scopri le finiture disponibili

Scan the QrCode and discover the available finishes

Scannez le QR Code e découvrez les finitions disponibles

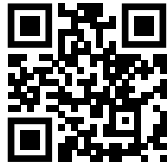

Scrivanie direzionali Executive desks | Bureaux de direction

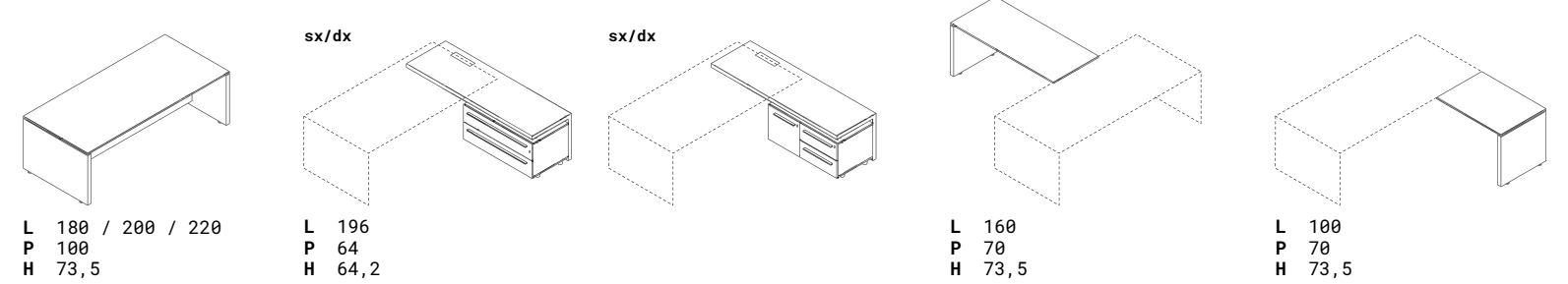

Tavoli riunione Meeting tables | Tables de réunion

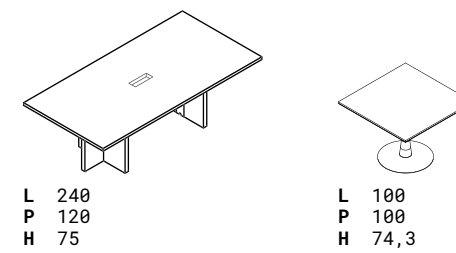

Cassettiere e mobili di servizio Pedestals and service units | Caissons et meubles de service

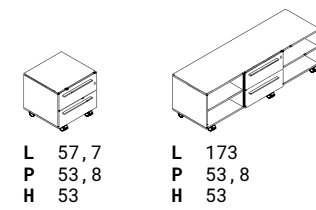

Mobili monolitici Monolith cabinets | Meubles monolithes

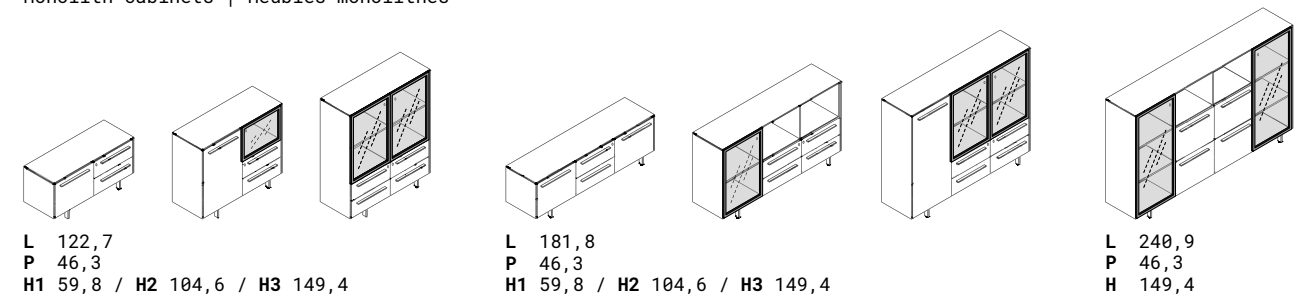



Una collezione in cui alluminio e legno dialogano fino a raggiungere il corretto equilibrio stilistico che soddisfa un pubblico dalle preferenze funzionali più diverse.

In this collection aluminium and wood interact to reach the right stylistic balance and satisfy users with the most diverse functional preferences.

Une collection où l'aluminium et le bois interagissent jusqu'à atteindre le correct équilibre stylistique pour satisfaire les préférences fonctionnelles les plus diverses.

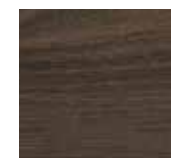

cod. 52



cod. IG 01



Le gambe mantengono la continuità visiva col piano grazie alla decorazione in finitura legno sulla faccia esterna alleggerita, internamente, dall'alluminio inox grey.

The legs maintain visual continuity with the worktop through the wood decoration on the external face, internally lightened by inox grey aluminium.

Les pieds montrent une continuité visuelle avec le plateau grâce à la décoration finition bois sur la face externe, où l'aluminium inox grey donne légèreté à l'ensemble.



← Il modesty panel completa la scrivania senza alterarne l'immagine complessiva.
The modesty panel completes the desk without altering the overall image.
L'écran « modesty panel » complète le bureau sans altérer son image globale.



← Giunzione tra piano e gamba evidenziata da profilo in alluminio.

The junction between the worktop and the legs is highlighted by an aluminium profile.

La jonction entre le plateau et le pied est mise en évidence par le profilé en aluminium.



→ Eleganza e modernità grazie all'abbinamento tra legno e alluminio.

The combination of wood and aluminium adds elegance and modernity.

Élégance et modernité grâce à la combinaison du bois et de l'aluminium.





L'ufficio direzionale si completa attraverso la postazione di lavoro e il tavolo riunioni. Un abbinamento estetico e funzionale che comunica efficienza ed eleganza.

A complete executive office: workstation and meeting table. An aesthetic and functional combination that communicates efficiency and elegance.

Le bureau de direction est complété par le poste de travail et la table de réunion. Une composition esthétique et fonctionnelle qui communique efficacité et élégance.

→
Tavolo tondo per piccole sale riunioni o all'interno dell'ufficio.
Round table for small meeting rooms or in the office.
Table ronde pour les salles de réunion plus petites ou à l'intérieur du bureau.

cod. IG 01 cod. 12

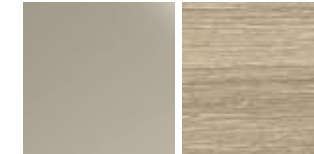

Inquadra il QrCode e scopri le finiture disponibili

Scan the QrCode and discover the available finishes

Scannez le QR Code e découvrez les finitions disponibles



Scrivanie direzionali Executive desks | Bureaux de direction

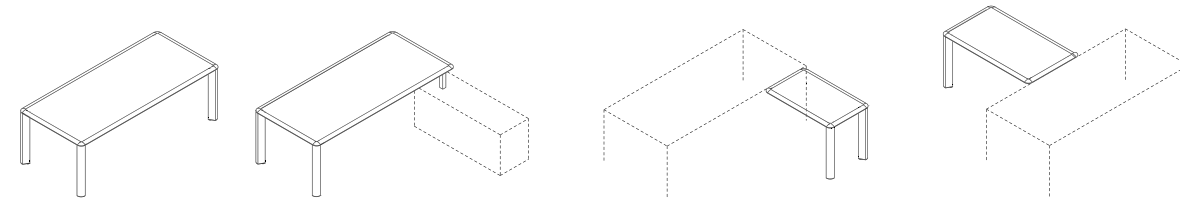

LxP 180 x 90
LxP 200 x 100 / 218 x 100
H 75

L 100
P 62,5
H 75

L 140
P 80
H 75

Tavoli riunione Meeting tables | Tables de réunion

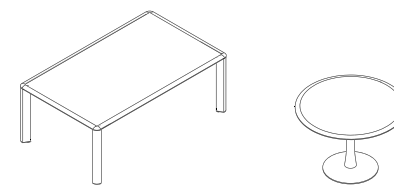

L 200 / 260
P 120
H 75

Ø 120
H 71,8

Cassettiere e mobili di servizio Pedestals and service units | Caissons et meubles de service

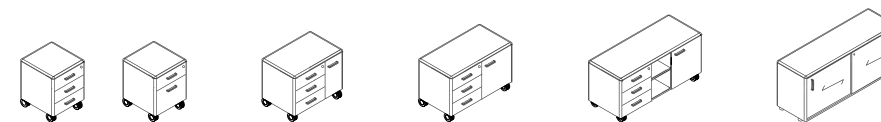

L 48,6
P 51,3
H 60

L 73,7
P 51,3
H 60

L 93,7
P 51,3
H 60

L 124,6
P 51,3
H 60

L 140,3
P 45,3
H 61,4

Elementi componibili Modular units | Meubles modulaires

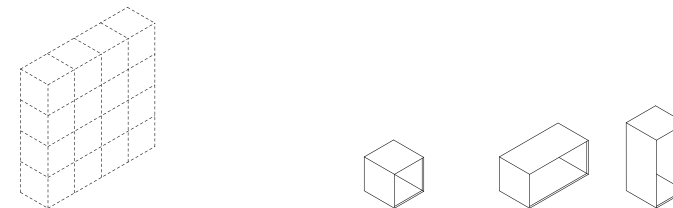

LxP 138,6 x 47,9
LxP 183,6 x 47,9
H1 90 / H2 135 / H3 180

L 45
P 46,3
H 45

L 90
P 46,3
H 45





cod. 64

La connessione a 45 gradi, tra piano e gamba, conferisce carattere e stile al prodotto. È la sintesi ideale tra pulizia formale e perfetta tecnica costruttiva.

La jonction à 45 degrés entre le plateau et le pied augment le caractère et le style de l'ensemble du bureau. C'est la synthèse idéale entre la propreté formelle et une technique de construction parfaite.

The 45-degree junction between top and legs gives character and style to the entire desk. This is the ideal synthesis between formal definition and impeccable construction technique.



← Vani porta oggetti nella scrivania e vani a giorno nei contenitori.
Storage compartments in the desk and open shelves in the units.
Compartiments porte-objets dans le bureau et rangements ouverts dans les meubles.



↑ Un modulo di cablaggio sotto piano discreto e funzionale.
A discreet and functional wiring module installed under the top.
Module de câblage sous le plateau, discret et fonctionnel.



cod. 27



Il tavolo riunioni richiama le linee della scrivania, sintetizzandone i tratti. La forma delle gambe pannellate consente un'ottimale fruizione da parte dei capo tavola.

This meeting table is inspired by the executive desk aesthetic lines that highlight its features. The shape of panelled legs allows optimal use of all available seats.

La table de réunion s'inspire aux lignes du bureau de direction, en résumant ses caractéristiques. La forme des pieds à panneaux permet une utilisation optimale des places en tête de table.



→ Tavolo riunioni quadrato con gamba pannellata centrale in colore nero.
Square meeting tables with black central panelled leg.
Table de réunion carrée avec pied central à panneaux de couleur noire.



Elite ESSENZA

La collezione aumenta il suo valore grazie all'impiego di due rivestimenti in tranciato di legno per piani ed ante.

L'aspetto tattile diventa fattore discriminante di scelta, il calore e la matericità diventano elementi caratterizzanti che superano ogni considerazione estetica.

This collection features the added value of two veneer finishes for doors and tops. The surface tactile feel becomes crucial in choosing this collection, heat and texture become characterising elements that go beyond any aesthetic consideration.

La collezione augmente sa valeur grâce à l'utilisation de deux revêtements en placage de bois pour les plateaux et les portes. L'aspect tactile devient un facteur de choix discriminant, la chaleur et les textures deviennent des éléments caractéristiques qui vont au-delà de toute considération esthétique.

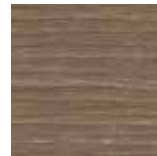

cod. 26

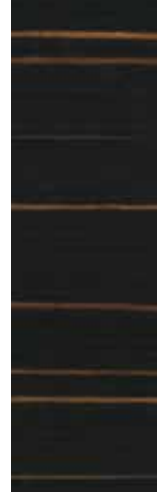

cod. 25



←
Tavolo riunioni con
modulo di cablaggio
centrale.
Meeting table with
central module for
wiring.
Table de réunion avec
module de câblage
central.



Inquadra il QrCode e scopri le finiture disponibili

Scan the QrCode and discover the available finishes

Scannez le QR Code e découvrez les finitions disponibles

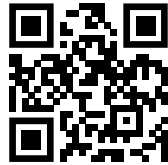

Scrivanie direzionali Executive desks | Bureaux de direction

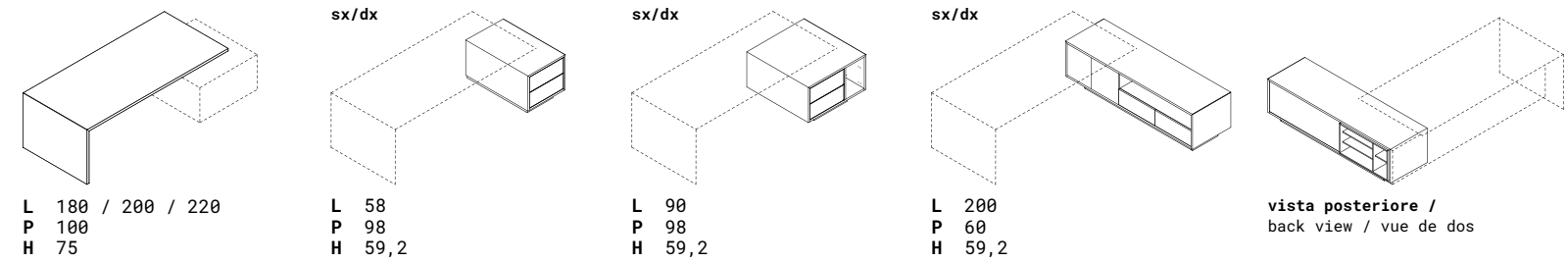

Tavoli da salotto e riunione Coffee and meeting tables | Tables de salon et de réunion

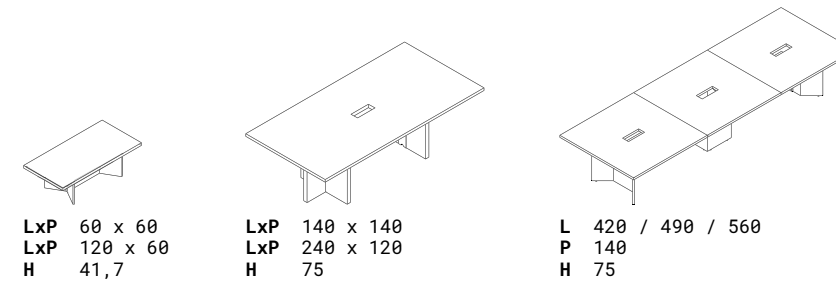

Pensili e monoliti Suspended elements and monoliths cabinets | Elements suspendus et meubles monolithiques

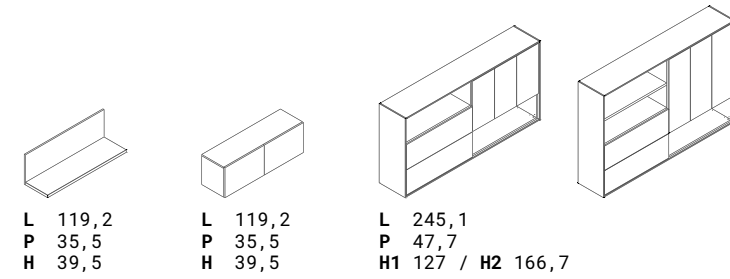





**Il contenitore a parete
esprime lo stesso
avvicendamento di vuoti
e di pieni che caratterizza
l'intera collezione.
Un filo conduttore stilistico
riconoscibile.**

The wall storage unit
features the same alternation
of empty and full volumes
that characterises the
entire collection.
A recognisable stylistic
thread.

Le rangement mural exprime
la même alternance de vides
et de pleins qui caractérise
toute la collection.
Un trait d'union stylistique
reconnaisable.

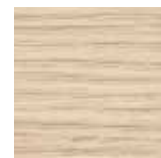

cod. 03



← Passacavi opzionale
per un funzionale
cablaggio dalla gamba
pannellata.

Optional cable guide
for functional
wiring, through the
panelled leg.

Passe-câble en option
pour un câblage
fonctionnel à partir
du pied à panneaux.



cod.68



cod.07

→
Il sottile
taglio
verticale
caratterizza
la gamba
pannellata.
The panelled
legs feature
a thin vertical
groove.
La coupe
verticale
étroite
caractérise
le pied à
panneaux.



Delta si distingue per piccoli dettagli. La giunzione tra piano e fianco, un'unione senza contatto visibile, valorizza lo spessore dei pannelli e li rende leggibili.

Delta is characterised by many small details. The junction between top and side panels, with no visible contact, enhances the panels thickness and highlights the design.

Delta se reconnaît dans ses petits détails. La jonction entre le dessus et le côté, une jonction sans contact visible, met en évidence l'épaisseur des panneaux et souligne leur visibilité.



Inquadra il QrCode e scopri le finiture disponibili

Scan the QrCode and discover the available finishes

Scannez le QR Code e découvrez les finitions disponibles



Scrivanie direzionali Executive desks | Bureaux de direction

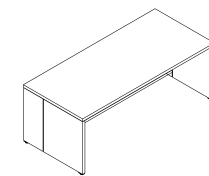

L 180 / 200
P 90
H 75

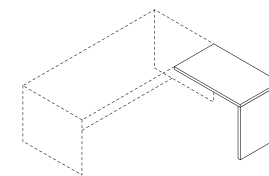

L 100
P 60
H 75

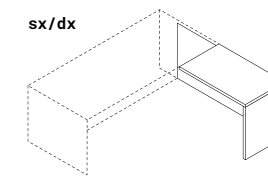

sx/dx

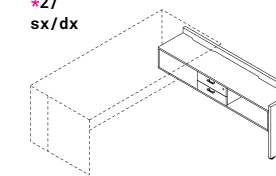

*2/
sx/dx

L 120
P 42
H 75

Tavoli riunione Meeting tables | Tables de réunion

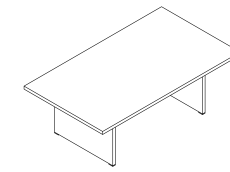

L 210 / 260
P 120
H 75

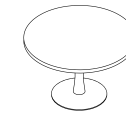

Ø 120
H 72,8

Mobili Cabinets | Meubles

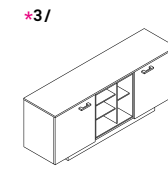

*3/
L 179,5
P 46,9
H 72,6

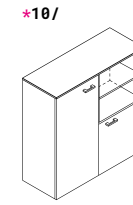

*10/

L 120,4
P 46,9
H 123,6

FIL ROUGE 5th ELEMENT OXI
UP SCHERMI PIEGO CHIUDO
SEGUO SHARE CUBO PRONTO
CONTENITORI UNIVERSALI
JERA ENOSI E.O.S. IULIO
ELITE DELTA **I-MEET** NICE POINT
PAUSA CONVIVIO FUNGO
SEGNO ICARO REGOLO KYOTO
PODIO LEAD JERA SCENA NEO
CHAIR TRAMA ATHENA FORMEN
GALASSIA STAR SISTEMA CAST
CIAK PRIMA RASSEGNA ESSAI
HELLÒ OSCAR F01 F02 F03 F04
VEDETTE FICTION TROUPE
ZOOM SUPEROTTO PROVINO
F01 BENCH F03 BENCH REGIA
MOVIE TRUKA FESTIVAL JETSET
JERA22 TREND SET22 DOMUS
DRIVE IN DIVO FLAGS TRAILER
WORKLAND





cod. 30



Tavoli riunioni in vari formati, variamente aggregabili fino alle grandi composizioni. La riduzione degli appoggi e la sezione snella delle gambe conferiscono grande leggerezza e stabilità ad ogni composizione, permettendo un perfetto utilizzo su ogni lato.

Meeting tables in different formats that can be combined in a number of ways up to large compositions. The reduction of supporting elements and the slender legs add lightness and stability to each composition, allowing perfect use on all sides.

Tables de réunion dans formats différents, qui peuvent être combinées pour obtenir de grandes compositions. La réduction des appuis et la section élancée des pieds donne une grande légèreté et stabilité aux compositions, pour une utilisation parfaite sur tous les côtés.



←
Tavolo riunioni in formato quadrato con top access centrale.
Square meeting table with central top access.
Table de réunion carré avec top access central.

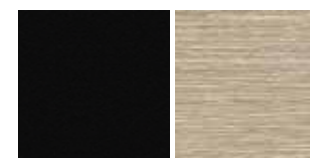

cod. NR 03 cod. 12





←
L'angolo smussato
mantiene lo stesso
allineamento della
gamba.
Bevelled corners
maintain the
alignment with the
legs.
Le coin arrondi
maintient le même
alignement du pied.

→
Tavolo riunioni
quadrato con
modulo tecnico
centrale.
Square meeting
table with
technical
central module.
Table de réunion
carré avec
module technique
central.



cod. 10

I piani di lavoro in cristallo retro laccato conferiscono grande eleganza al tavolo riunioni e si pongono in contrapposizione col modulo tecnologico centrale in legno. Un ulteriore livello di pregio di materiali ed abbinamenti per un meeting moderno ed elegante.

Back-lacquered glass worktops give great elegance to the meeting table and create contrast with the wood of the central technical module. An additional level of quality in materials and combinations, for modern and elegant meetings.

Les plans de travail en verre rétro-laqué donnent une grande élégance à la table de réunion et contrastent avec le module technologique central en bois. Un ultérieur niveau de prestige dans les matériels et les combinaisons pour des rencontres modernes et élégants.

Inquadra il QrCode e scopri le finiture disponibili

Scan the QrCode and discover the available finishes

Scannez le QR Code e découvrez les finitions disponibles

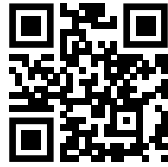

Tavoli riunione
Meeting tables | Tables de réunion

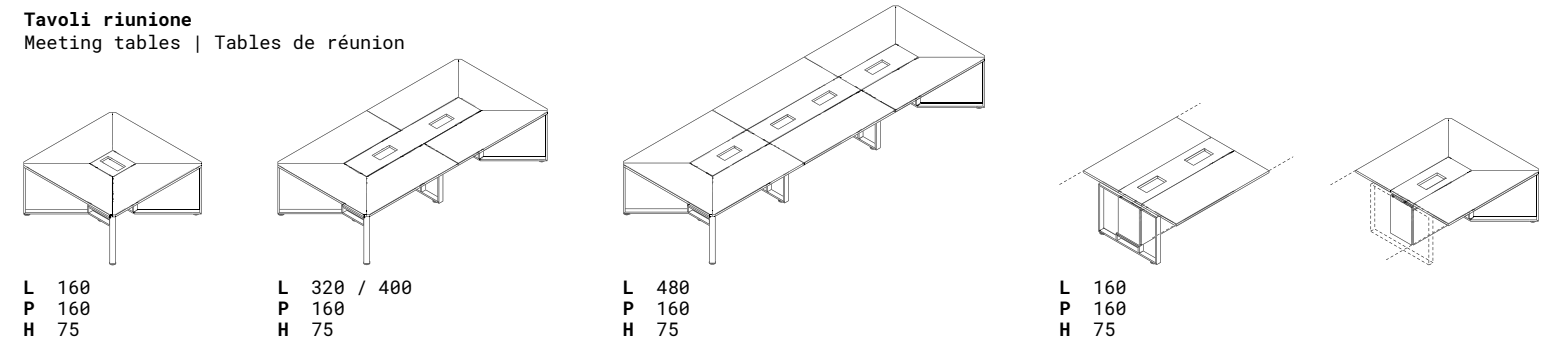

L 160
P 160
H 75

L 320 / 400
P 160
H 75

L 480
P 160
H 75

L 160
P 160
H 75

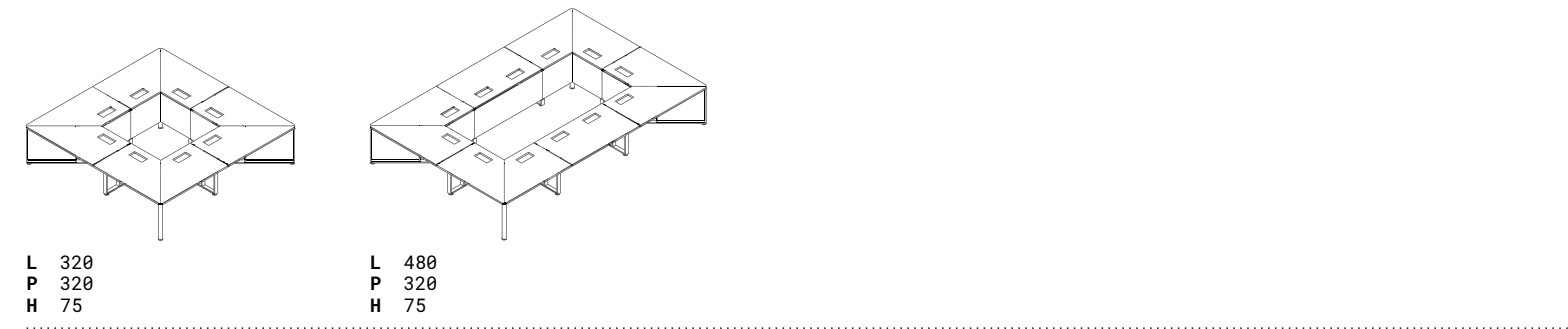

L 320
P 320
H 75

L 480
P 320
H 75

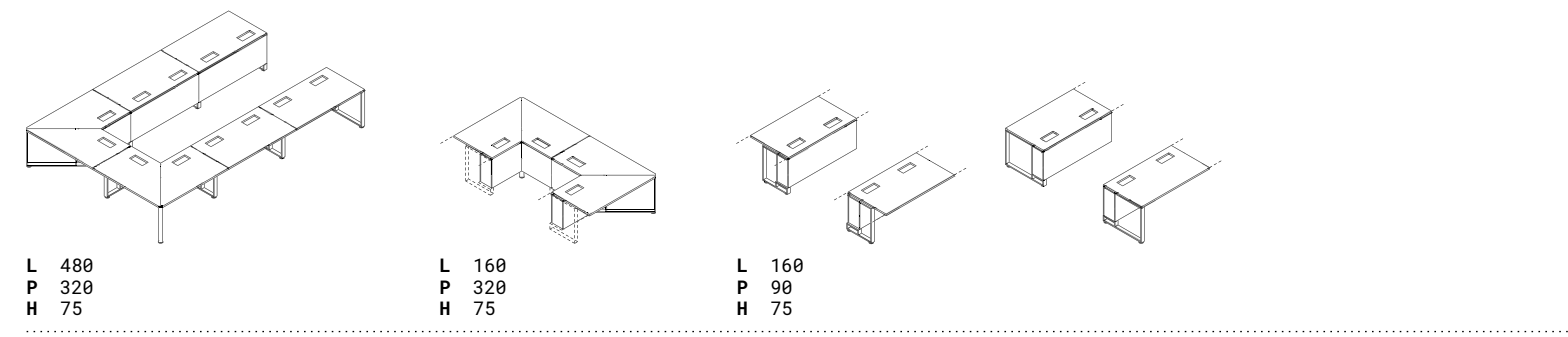

L 480
P 320
H 75

L 160
P 320
H 75

L 160
P 90
H 75

Complementi di arredo
Accessories | Meubles de rangements

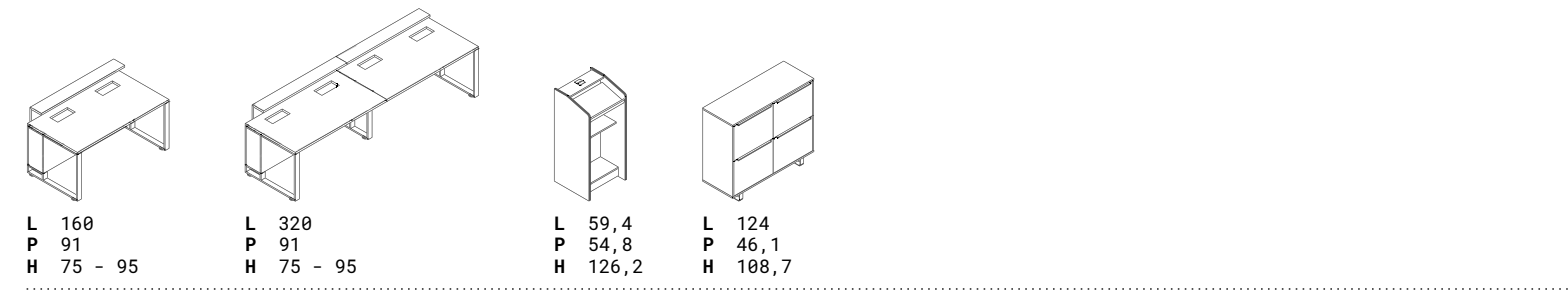

L 160
P 91
H 75 - 95

L 320
P 91
H 75 - 95

L 59,4
P 54,8
H 126,2

L 124
P 46,1
H 108,7

FIL ROUGE 5th ELEMENT OXI
UP SCHERMI PIEGO CHIUDO
SEGUO SHARE CUBO PRONTO
CONTENITORI UNIVERSALI
JERA ENOSI E.O.S. IULIO
ELITE DELTA I-MEET **NICE POINT**
PAUSA CONVIVIO FUNGO
SEGNO ICARO REGOLO KYOTO
PODIO LEAD JERA SCENA NEO
CHAIR TRAMA ATHENA FORMEN
GALASSIA STAR SISTEMA CAST
CIAK PRIMA RASSEGNA ESSAI
HELLÒ OSCAR F01 F02 F03 F04
VEDETTE FICTION TROUPE
ZOOM SUPEROTTO PROVINO
F01 BENCH F03 BENCH REGIA
MOVIE TRUKA FESTIVAL JETSET
JERA22 TREND SET22 DOMUS
DRIVE IN DIVO FLAGS TRAILER
WORKLAND





→
 Modulo frontale a
 fasce orizzontali
 e mensola in legno.
 Front module with
 horizontal bands
 and wooden shelf.
 Module frontal
 à bandes
 horizontales et
 étagère en bois.



cod. 12

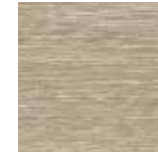

↑
 Contenitori Storage a
 cassetto estraibile
 per l'intensa
 operatività.
 Storage containers with
 removable drawer for
 high-pace activity.
 Rangements Storage à
 tiroir extractible pour
 une activité dynamique.

**Nice è una collezione
 reception ben strutturata
 e ricca di componenti ed
 accessori che consente di
 progettare composizioni
 di grande complessità e
 di forte impatto scenico.**

Nice is a well structure
 reception system enriched
 by many components
 and accessories that can
 be combined to design
 compositions of great
 complexity and strong
 visual impact.

Nice est une collection
 de comptoirs d'accueil
 bien structurée et riche en
 composants et accessoires
 qui permettent de concevoir
 compositions d'une grande
 complexité à fort impact
 visuel.



L'articolazione delle altezze definisce le differenti funzioni della reception: operatività, ricevimento in piedi, conversazione o accoglienza di ospiti diversamente abili. Nice soddisfa ogni esigenza senza mai perdere la sua eleganza.

Different heights to define the various functions of the reception counter: operation, standing reception, conversation or welcoming of guests with disabilities. Nice meets all needs without ever losing its elegance.

L'articulation des hauteurs trace les différentes fonctions de l'accueil : opérations, accueil debout, conversation ou accueil de personnes en situation de handicap. Nice satisfait toutes les exigences tout en gardant son élégance sans jamais la perdre.



cod.30

→ Fianco terminale con profilo in alluminio cromo satinato.
End side panel edged with satin chrome-finished aluminium profile.
Côté terminal avec bord profilé en aluminium chromé satiné.



Inquadra il QrCode e scopri le finiture disponibili

Scan the QrCode and discover the available finishes

Scannez le QR Code e découvrez les finitions disponibles

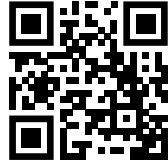

Moduli
Modules | Modules

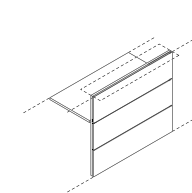

L 80 / 120 / 180
P 70,1
H 106,5

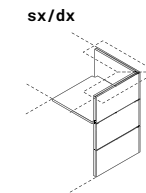

L 70,1
P 70,1
H 106,5

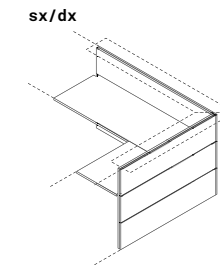

L 185,1
P 150,1
H 106,5

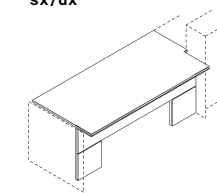

L 190
P 90
H 73,5

sx/dx

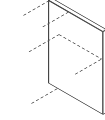

L 83,7
P 5
H 110,3

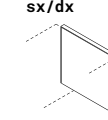

L 83,7
P 5
H 74,3

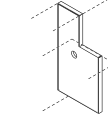

L 59,8
P 5
H 110,3

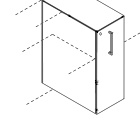

L 41,6
P 83,7
H 110,3

Mensole
Shelves | Etageres

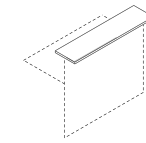

L 80 / 120 / 180
P 30
H1 2,5 / H2 1,2

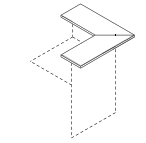

L 82 - 82
P 30
H1 2,5 / H2 1,2

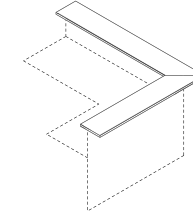

L 162 - 197
P 30
H1 2,5 / H2 1,2

Point

SI Design - CSR Las Mobili



Point è una reception ispirata a criteri di rigore formale che si articola in moduli variamente aggregabili tra loro. La semplicità compositiva e lo stile minimale generano infinite composizioni, con forme e dimensioni differenti, adattabili in ogni contesto.

The Point reception desk is inspired to formal rigour criteria declined in versatile modules that can be combined together. The simplicity in the composition and its minimal style generate infinite combinations, with different shapes and sizes, that can be adapted to any context.

cod. 03



Point est un comptoir inspiré aux critères de rigueur formelle articulés dans de modules qui peuvent être différemment combinés. La simplicité de la composition et son style minimaliste permettent de créer des compositions infinies, avec différentes formes et tailles, adaptables dans tous les contextes.

→ Fianco strutturale che chiude lateralmente ogni modulo.
Side structural element the literally closes each module.
Côté structurel qui ferme chaque module latéralement.





I moduli più semplici e di dimensioni ridotte garantiscono le stesse dotazioni e funzionalità delle composizioni più articolate. I piani di lavoro, differenti per ospiti ed operatori, si distinguono chiaramente per l'altezza da terra.

The simplest and the smallest modules provide the same features and functionality as the most complex compositions. Different worktops for guests and operators, clearly distinguishable by their height.

Les modules les plus simples et les plus petits offrent les mêmes caractéristiques et fonctionnalités de compositions les plus articulées. Les plans de travail, différents pour les visiteurs et les opérateurs, se distinguent clairement par leur hauteur par rapport au sol.



cod. 38

→ Piano di ricevimento per ospiti disabili.
Reception worktop for disabled guests.
Plan d'accueil pour personnes à mobilité réduite.



cod. 63

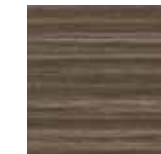



L'effetto cromatico e materico delle mensole metalliche valorizza il bancone di ricevimento evolvendo la linearità originaria del progetto.

The chromatic and material effect of metal shelves adds value to the reception counter through the evolution of the original linearity of this project.

L'effet chromatique et des matériaux des étagères en métal valorise le comptoir d'accueil en soulignant l'évolution de la linéarité originale du projet.



cod.VR 02



→
Mensole lineari in acciaio verniciato in nove colori.
Linear shelves in painted steel, available in nine colours.
Étagères linéaires en acier peint en neuf couleurs.

→
Il ridotto spessore della lamiera enfatizza il pannello strutturale in legno.
The reduced thickness of the metal sheet highlights the structural wooden panel.
L'épaisseur réduite de la tôle souligne le panneau structural en bois.



cod.68



cod.CP 01

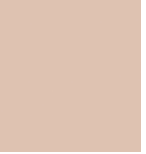

Inquadra il QrCode e scopri le finiture disponibili

Scan the QrCode and discover the available finishes

Scannez le QR Code e découvrez les finitions disponibles

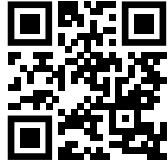

Reception Reception | Réception

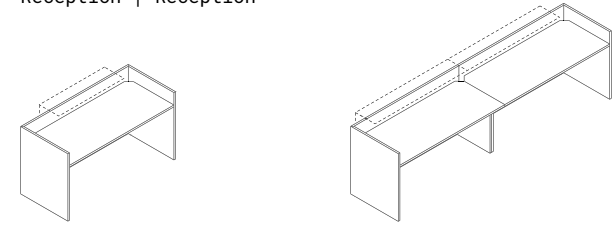

L 125 / 145 / 165 / 185
P 72,5
H 105

L 245 / 285 / 325 / 365
P 72,5
H 105

Moduli Modules | Modules

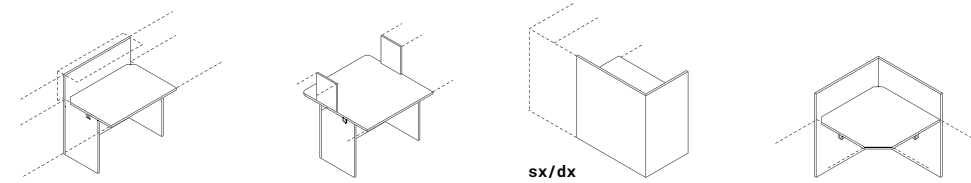

L 100
P 72,5
H 105

L 100
P 100
H 105

sx/dx
L 102,5
P 62,5
H 105

L 92,5
P 92,5
H 105



sx/dx
L 122,5 / 142,5 / 162,5 / 182,5
P 72,5
H 105

sx/dx
L 122,5
P 122,5
H 105

Mensole Shelves | Etageres

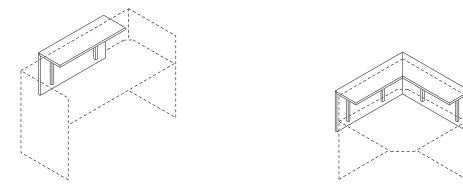

L 100 / 120 / 140 / 160
P 30
H 50

L 97,5 - 97,5
P 30
H 50

Cattedre Conference desks | Bureaux conference

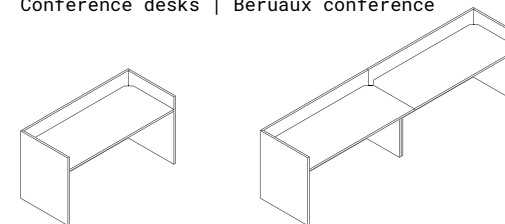

L 165
P 72,5
H 90

L 325
P 72,5
H 90

tavoli break & coffee
break & coffee tables
break & basses tables

FIL ROUGE 5th ELEMENT OXI
UP SCHERMI PIEGO CHIUDO
SEGUO SHARE CUBO PRONTO
CONTENITORI UNIVERSALI
JERA ENOSI E.O.S. IULIO
ELITE DELTA I-MEET NICE POINT
PAUSA CONVIVIO FUNGO
SEGNO ICARO REGOLO KYOTO
PODIO LEAD JERA SCENA NEO
CHAIR TRAMA ATHENA FORMEN
GALASSIA STAR SISTEMA CAST
CIAK PRIMA RASSEGNA ESSAI
HELLÒ OSCAR F01 F02 F03 F04
VEDETTE FICTION TROUPE
ZOOM SUPEROTTO PROVINO
F01 BENCH F03 BENCH REGIA
MOVIE TRUKA FESTIVAL JETSET
JERA22 TREND SET22 DOMUS
DRIVE IN DIVO FLAGS TRAILER
WORKLAND

Pausa T

CSR Las Mobili

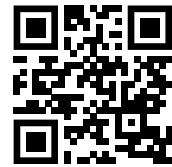

Tavolo break alto con piano rettangolare in legno o vetro e struttura metallica a gambe perimetrali e barre poggiapiedi.

High break table with rectangular top in wood or glass and metal structure with external legs and footrest bars.

Table break haute avec plateau rectangulaire en bois ou en verre et structure en métal avec pieds périmétraux et barres repose-pieds.



Pausa P

CSR Las Mobili



Tavolo break alto con piano rettangolare e struttura pannellata in legno e barre poggiapiedi in tubo di acciaio inox.

High break table with rectangular top, wooden panelled structure and footrest bars in stainless steel tube.

Table break haute avec plateau rectangulaire et structure à panneaux en bois et barres repose-pieds en tube d'acier inoxydable.

cod. 03



Convivio

CSR Las Mobili



Tavolo break o da pranzo con piano rettangolare in legno e struttura metallica a gambe perimetrali. La semplicità morfologica e le caratteristiche dei materiali lo rendono particolarmente adatto all'allestimento di spazi mensa ad elevata frequentazione.

Break or dining table with rectangular wooden top and metal frame with external legs. Its morphological simplicity and the material characteristics make it particularly suitable for busy canteen spaces.

Table break ou pour cantine, avec plateau en bois rectangulaire et structure en métal avec pieds périmétraux. La simplicité morphologique et les caractéristiques des matériaux le rendent idéal pour l'aménagement des cantines à haute fréquentation.



Fungo

CSR Las Mobili



Tavoli a basamento centrale con piani rettangolari e quadrati in due altezze, break e pranzo. I piani, con i bordi arrotondati e rivestimento in 3D Foil, sono comodi e facilmente pulibili. Il basamento annulla gli ingombri perimetrali favorendo l'uso perimetrale.

Tables with central base, rectangular and square tops available in two heights, for break areas and canteens. Round-edged tops and 3D Foil coating make them comfortable and easy to clean. The central base frees the table perimeter for a better use of space.

Tables avec base centrales et plateaux rectangulaires et carrés en deux hauteurs, pour le break et la cantine. Les plateaux, grâce aux bords arrondis et au revêtement 3D Foil, sont confortables et faciles à nettoyer. La base élimine l'encombrement du périmètre favorisant l'utilisation de toutes les places disponibles.



Seguo coffee



Negli smart office le aree operative o riunioni si caratterizzano per gli imbottiti acustici in cui il tavolo varia l'altezza del piano a seconda dalla specifica funzione.

In smart offices, operational or meeting areas feature acoustic upholstery and tables of different heights to suit their specific functions.

Dans les bureaux intelligents, les zones opérationnelles ou de réunion sont caractérisées par des éléments rembourrés acoustiques, où la table varie la hauteur du plateau selon la fonction choisie.

cod. 51



Fungo coffee

CSR Las Mobili



Il tavolo di servizio diventa capiente e comodo grazie ai due formati di piano, quadrato e rettangolare, che permettono un utilizzo completo come elemento di supporto per la pausa informale o come tavolo da lavoro in aree per riunioni agili.

A service table that becomes spacious and comfortable thanks to its two top formats, square and rectangular, which optimise its usability as a support element for an informal break or as a work table for agile meetings.

La table de service devient confortable et spacieuse grâce aux deux formats du plateau, carré et rectangulaire, qui permettent une utilisation complète comme élément de support pour une pause informelle ou comme table de travail dans les zones de réunions agiles.



Segno

CSR Las Mobili

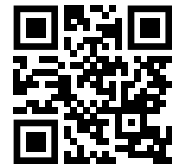

La struttura metallica a tubolari perimetrali definisce l'archetipo del tavolo che, in versione break, è valorizzato dalla grande proposta di finiture e colori.

The metal structure with perimeter tubular elements defines the table archetype which, in its break version, is enhanced by the wide range of finishes and colours.

La structure en métal avec ses tubes périmétraux dessine l'archétype de la table qui, dans la version break, acquiert valeur grâce à la riche gamme de finitions et de couleurs.



Icaro

CSR Las Mobili

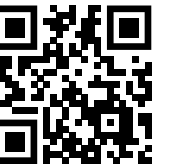

Un elemento con struttura e piano interamente in legno. Gli effetti estetici di nobilitato e 3D Foil caratterizzano i piani enfatizzando i colori pieni e le essenze. La struttura in nobilitato è in finitura o a contrasto, creando un gradevole risultato materico.

Element with all wood structure and top. The aesthetic effects of melamine and 3D Foil characterise these tops, enhancing both their colours and wood finishes. The melamine-finished structure has a matching or contrasting finish, to create a pleasant material result.

Un élément avec structure et plateau complètement en bois. Les effets esthétiques du mélaminé et de la feuille 3D caractérisent les plateaux et soulignent les couleurs pleines et les essences. La structure en mélaminé est en finition ou en contraste, pour donner un résultat agréable.

cod. 38

cod. 59

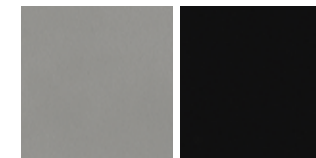

Regolo

CSR Las Mobili

Una struttura lineare totalmente esterna al piano proposta in 2 altezze, leggera e moderna. Accoglie piani in melaminico, 3D foil e vetro creando effetti cromatici inaspettati. La doppia altezza permette di soddisfare esigenze funzionali e compositive diverse e personali.

A linear structure totally external to the tabletop proposed in 2 heights, light and modern. It accommodates melamine tops, 3D foil and glass, creating unexpected colour effects. The double height allows different functional and compositional requirements to be met.

Une structure linéaire totalement indépendante du plateau proposé en 2 hauteurs, légère et moderne. Elle s'adapte aux plateaux en mélamine, en feuille métallique 3D et en verre créant des effets chromatiques inattendus. Sa double hauteur permet de répondre à des exigences fonctionnelles et compositionnelles différentes et personnalisées.

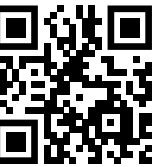

cod. 44



cod. 56



cod. 82



cod. 44



cod. 68

Kyoto

CSR Las Mobili

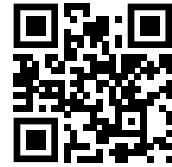

Una base a croce che si apre diventando supporto per il piano.
Una soluzione compositiva in tre altezze di struttura e tre dimensioni di piani.
Totalmente in metallo e disponibile nelle dieci colorazioni previste.

A cross-shaped base that opens to become a support for the tabletop.
A compositional solution in three heights for frames and three sizes for tabletop.
Entirely made of metal and available in ten colours.

Une base en forme de croix qui s'ouvre pour devenir un support pour le plateau.
Une solution composée en trois hauteurs de structure et trois tailles de plateau.
Entièrement en métal et disponible dans les dix coloris prévus.



Podio

CSR Las Mobili



Una struttura in lamiera sagomata, sottile e slanciata, nei dieci colori a catalogo.
L'astrazione stilistica di stili noti che porta alla creazione di piccoli tavoli di servizio dalle proporzioni nuove.

A slender, contoured sheet metal structure in ten catalogue colours.
The stylistic abstraction of familiar stylistic features leads to the creation of small service tables with new proportions.

Une structure en tôle profilée, fine et élancée, dans les dix couleurs du catalogue.
L'abstraction stylistique de styles connus qui conduit à la création de petites tables de service aux proportions nouvelles.



Inquadra il QrCode e scopri le finiture disponibili

Scan the QrCode and discover the available finishes

Scannez le QR Code e découvrez les finitions disponibles



Pausa T

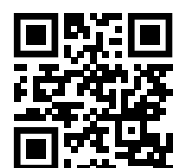

Pausa P



Convivio



Fungo



Seguo coffee



Fungo coffee



Segno



Icaro



Regolo



Kyoto



Podio

Tavoli break | Tables for break areas | Tables break

Pausa T

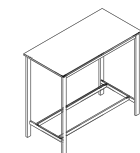

L 120
P 60
H 110

Pausa P

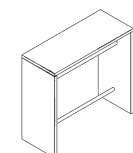

L 120
P 50
H 110

Convivio

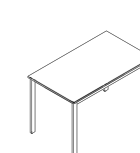

L 120
P 70
H 75

Fungo

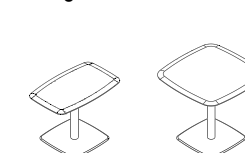

LxP 80 x 50
LxP 80 x 80
H1 60 / H2 73

Tavoli coffee | Coffee tables | Tables basses

Seguo coffee

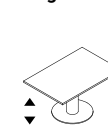

L 90
P 60
H 47,5 / 73,5

Fungo coffee

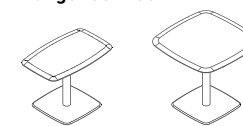

LxP 80 x 50
LxP 80 x 80
H 45

Segno

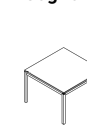

LxP 60 x 60
LxP 80 x 80
H 40

Icaro

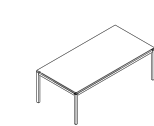

L 120
P 60
H 40

Icaro

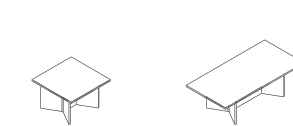

L 60 / 120
P 45,2
H 40

Regolo



L 53
P 53
H 32,6 / 46,3



L 60
P 60
H 32,6 / 46,3

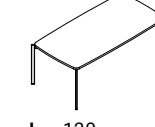

L 120
P 60
H 32,6 / 46,3

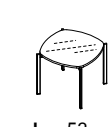

L 53
P 53
H 31,8 / 45,5

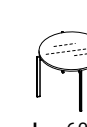

L 60
P 60
H 31,8 / 45,5

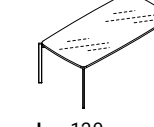

L 120
P 60
H 31,8 / 45,5

Kyoto



L 80
P 80
H 30,5



L 60
P 60
H 37,2



L 47
P 47
H 44,5



L 60
P 60
H 31,8



L 60
P 60
H 45,5



L 60
P 60
H 31



L 60
P 60
H 44,7



L 60
P 60
H 30,3



L 60
P 60
H 44

Podio



L 60
P 60
H 31,8



L 60
P 60
H 45,5



L 60
P 60
H 31



L 60
P 60
H 44,7



L 60
P 60
H 30,3



L 60
P 60
H 44

FIL ROUGE
5th ELEMENT OXI UP
SCHERMI PIEGO CHIUDO
SEGUO SHARE CUBO
PRONTO CONTENITORI
UNIVERSALI JERA
ENOSI E.O.S. IULIO ELITE
DELTA I-MEET NICE
POINT PAUSA CONVIVIO
FUNGO SEGNO ICARO
REGOLO KYOTO PODIO

LEAD JERA SCENA
NEO CHAIR TRAMA
ATHENA FORMEN
GALASSIA STAR
SISTEMA CAST CIAK
PRIMA RASSEGNA
ESSAI HELLO OSCAR
F01 F02 F03 F04 VEDETTA
FICTION TROUPE ZOOM
SUPEROTTO PROVINO
F01 BENCH F03 BENCH
REGIA MOVIE TRUKA
FESTIVAL JETSET
JERA22 TREND SET22
DOMUS DRIVE IN
DIVO FLAGS TRAILER
WORKLAND

sedute direzionali
executive chais
fauteuil de direction

FIL ROUGE 5th ELEMENT OXI
UP SCHERMI PIEGO CHIUDO
SEGUO SHARE CUBO PRONTO
CONTENITORI UNIVERSALI
JERA ENOSI E.O.S. IULIO
ELITE DELTA I-MEET NICE POINT
PAUSA CONVIVIO FUNGO
SEGNO ICARO REGOLO KYOTO
PODIO **LEAD JERA SCENA NEO**
CHAIR TRAMA ATHENA FORMEN
GALASSIA STAR SISTEMA CAST
CIAK PRIMA RASSEGNA ESSAI
HELLÒ OSCAR F01 F02 F03 F04
VEDETTE FICTION TROUPE
ZOOM SUPEROTTO PROVINO
F01 BENCH F03 BENCH REGIA
MOVIE TRUKA FESTIVAL JETSET
JERA22 TREND SET22 DOMUS
DRIVE IN DIVO FLAGS TRAILER
WORKLAND

Lead

Giacobone & Roj - Progetto CMR





cod.774



cod.773

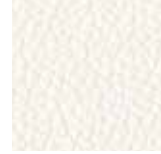

←
I braccioli imbottiti e completamente rivestiti esprimono comfort e grande qualità costruttiva.
Upholstered and finished armrests communicate comfort and high structural quality.
Les accoudoirs rembourrés et entièrement revêtus communiquent le confort et expriment l'excellente qualité de la construction.

Lead rappresenta, attraverso le sue forme e le proprie dotazioni, il ruolo di chi la utilizza e la funzione dell'ambiente in cui viene inserita, caratterizzandosi e caratterizzando in modo sempre diverso.

Through its forms and its equipment, Lead communicates the user's position and the function of the environment in which it is set, standing out and characterising it in an ever-new way.

Lead exprime, à travers ses formes et ses accessoires, le rôle de l'utilisateur et la fonction de l'environnement dans lequel il est inséré, en se proposant avec une caractérisation différente à chaque fois.



→
I braccioli in alluminio pressofuso alleggeriscono la poltrona conferendole stile e modernità.
The die-cast aluminium armrests lighten the armchair and give it a stylish and modern look.
Les accoudoirs en aluminium moulé sous pression donnent au fauteuil légèreté, style et modernité.







cod. 603



La comodità della poltrona è aumentata dal poggiatesta imbottito e dal cuscino, con rivestimento uniforme o differenziato. Stile e comfort sono perfettamente armonizzati.

The comfort of this chair is increased by the upholstered headrest and seat, with plain or matching patterns. Perfectly harmonised style and comfort.

Le confort du fauteuil est augmenté par l'appui-tête rembourré et par le coussin, avec sa couverture uniforme ou différenciée. Une harmonie parfaite de style et de confort.



cod. 777

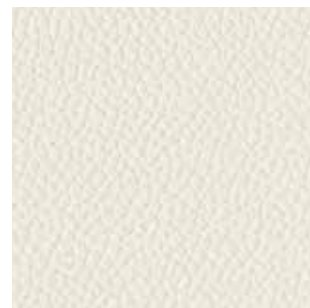

executive chairs



cod. 693



fauteuil de direction

sedute direzionali



Le poltroncine per gli ospiti sono proposte con due versioni di basi, a slitta e piramidale a quattro razze.

Les fauteuils visiteur sont proposés avec deux versions pour la base, à traineau et pyramidale à quatre rayons.

Guests' armchairs are available with cantilever frame or with four-wheel base.



→ Lo schienale è composto da cuscini orizzontali che rendono la postura confortevole e elegante.
The backrest comes with horizontal cushions that ensure a comfortable and elegant posture.
Le dossier a des coussins horizontaux qui rendent la posture confortable et élégante.



Una collezione direzionale completa che si compone di poltrona a schienale alto, medio e di sedute per ospiti.

A complete executive collection that includes armchairs with high or medium backrest and guests' seating.

Une collection de direction complète qui se compose d'un fauteuil à dossier haut ou moyen et de sièges pour les visiteurs.

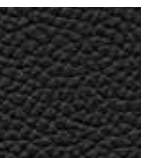

cod. 776

NeoChair

Giacobone & Roj - Progetto CMR



L'imbottitura è sobria e confortevole, caratterizzata unicamente dalle cuciture che disegnano lo schienale. Segni chiari e netti che conferiscono modernità e stile. I braccioli, regolabili o fissi ad anello, riescono a trasformare completamente la poltrona variandone il design, il livello di rappresentatività, la funzionalità.

The upholstery is simple yet comfortable, marked only by the seams lines on the backrest. Clear and neat signs that make it modern and stylish. The armrests, adjustable or fixed and ring-shaped, can completely transform the chair by improving its design as well as the function and position it represents.

Le rembourrage est sobre et confortable, caractérisé seulement par les coutures qui dessinent le dossier. Des lignes claires et nettes qui expriment modernité et style. Les accoudoirs, réglables ou fixés en forme d'anneau, peuvent complètement transformer le fauteuil en variant son design, son niveau de représentativité et sa fonctionnalité.

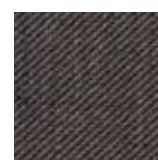

cod. 694

←
Le cuciture di seduta e schienale creano un piacevole effetto tridimensionale.

The stitching on the seat and the backrest creates a pleasant 3-D effect.

Les coutures de l'assise et du dossier créent un agréable effet tridimensionnel.

Un'accurata selezione di tessuti permette di ampliare le possibilità di rivestimento, superando le classiche in pelle. Ogni preferenza stilistica risulta perfettamente soddisfatta.

Une sélection précise et nouvelle de tissus permet d'élargir les possibilités de recouvrement, en surpassant le cuir classique. Chaque préférence stylistique est parfaitement satisfaite.

An accurate and innovative selection of fabrics expands the range of available coverings, going beyond classic leather chairs. Every stylistic preference can be perfectly satisfied.







cod. 957



Proposta in due altezze, può essere accessoriata con un bracciolo di design che affianca la struttura dello schienale.

Available in two heights, it can be accessorised with a designer armrest that flanks the backrest frame.

Disponible en deux hauteurs, elle peut être équipée d'un accoudoir design qui accompagne la structure du dossier.



Athena

CSR Las Mobili



La versione cantilever, dalla forma sinuosa e esile, mantiene perfettamente il carattere della poltrona completando in modo uniforme la collezione.

The cantilever version, with its neat curve lines, enhances the armchair personality and completes the collection with consistent and stylish combinations.

La version en cantilever, avec sa ligne souple e légère, maintient parfaitement le caractère du fauteuil, complétant la collection avec uniformité.



cod. 773

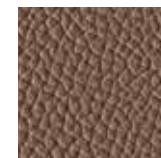

cod. 779







cod. 773



La morbidezza dell'imbottitura di seduta e schienale aumenta la comodità e caratterizza lo stile.

Soft upholstery for the seat and the backrest to increase comfort and enhance style.

La souplesse de l'embourrage de l'assise et du dossier augment le confort e caractérise le style.



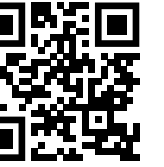

I braccioli caratterizzano in modo unico la poltrona, la soluzione fissa dalla forma arcuata conferisce grande modernità e stile.

Les accoudoirs caractérisent fortement le fauteuil, et la solution fixe avec sa forme arquée lui donnent grande modernité et style.

The armrests enhance the personality of this armchair, thanks to its arched shape which makes it modern and stylish.



cod. 695

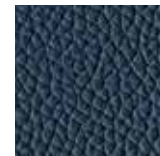

cod. 786

↑
Lo schienale schermo la seduta e definisce una visione posteriore nuova, slanciata e leggera.

The backrest dominates the seat and outlines a new backside perspective, slender and light.

Le dossier domine l'assise et définit une perspective arrière nouvelle, élégante et légère.



FIL ROUGE 5th ELEMENT OXI
UP SCHERMI PIEGO CHIUDO
SEGUO SHARE CUBO PRONTO
CONTENITORI UNIVERSALI
JERA ENOSI E.O.S. IULIO
ELITE DELTA I-MEET NICE POINT
PAUSA CONVIVIO FUNGO
SEGNO ICARO REGOLO KYOTO
PODIO LEAD JERA SCENA NEO
CHAIR TRAMA ATHENA FORMEN
GALASSIA **STAR SISTEMA CAST**
CIAK PRIMA RASSEGNA ESSAI
HELLÒ OSCAR F01 F02 F03 F04
VEDETTE FICTION TROUPE
ZOOM SUPEROTTO PROVINO
F01 BENCH F03 BENCH REGIA
MOVIE TRUKA FESTIVAL JETSET
JERA22 TREND SET22 DOMUS
DRIVE IN DIVO FLAGS TRAILER
WORKLAND



Il supporto lombare a regolazione manuale permette il completo contatto con lo schienale, adattando la seduta alle caratteristiche antropometriche dell'operatore in modo personale e variabile.

The manually adjustable lumbar support allows full contact with the backrest, adapting the seat to the operator's anthropometric characteristics in a personal and variable way.

Le support lombaire à réglage manuel permet un contact complet avec le dossier, en adaptant l'assise aux caractéristiques anthropométriques de l'opérateur de manière personnalisée et variable.



sedute operative

operative chairs

sièges de travail



La poltroncina cantilever garantisce una perfetta armonia stilistica con la versione operativa. Può essere collocata alla scrivania lato ospite o per allestire piccole sale riunioni.

Le fauteuil cantilever garantit une parfaite harmonie stylistique avec la version opérationnelle. Il peut être placé près du bureau côté invité ou utilisé pour aménager de petites salles de réunion.

The cantilever armchair guarantees perfect stylistic harmony with the operational version. It can be placed at the guest side desk or to set up small meeting rooms.



cod. C12

cod. E04



Bianco
White
Blanc

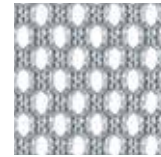

Grigio
Grey
Gris

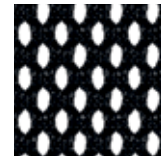

Nero
Black
Noir



Verde
Green
Vert



Blu
Blue
Bleu

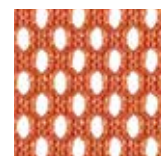

Arancio
Orange
Orange

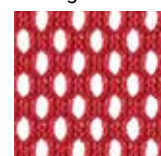

Rosso
Red
Rouge





←
La versione per ospiti su slitta è dotata di una struttura in tubo di acciaio cromato e schienale sagomato in rete o imbottito.

The cantilever version for visitors is fitted with a chrome finished steel tube frame and mesh or upholstered shaped backrest.

La version à traineau pour visiteurs a une structure en tuyau en acier chromé et dossier en maille ou rembourré.

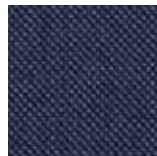

cod. 697



cod. 633



La poltroncina in rete si caratterizza per lo schienale ergonomico fortemente avvolgente. Una versione dal design raffinato destinata ad un pubblico che ricerca efficienza e comfort.

The mesh version is characterised by its fully enveloping ergonomic backrest. A sophisticated design to address an audience that seeks efficiency and comfort.

Cette chaise en maille se caractérise pour son dossier ergonomique très enveloppant. Une version de design raffiné, adressée au publique le plus exigeant qui recherche efficacité et confort.







←
Gli schienali offrono diverse combinazioni cromatiche di strutture e reti. Cast rete si pone come modello ideale per un pubblico giovane e dinamico.

Backrests are available in different colour combinations of the frames and mesh parts. Mesh-finished Cast makes the ideal chair for young and dynamic users.

Les dossiers permettent des différentes combinaisons chromatiques de structures et maille. Cast en maille se propose comme modèle idéal pour un public jeune et dynamique.



cod. 529



cod. 691

La versione con struttura bianca alleggerisce le forme e modifica completamente le proporzioni della seduta rendendola aperta ad ogni abbinamento cromatico.

The white frame version lightens shapes and completely changes the chair proportions making it open to any colour combination.

La version avec le châssis en blanc légèreté aux formes et modifie complètement les proportions de la chaise en permettant une grande variété de combinaisons de couleurs.







cod. 610

La seduta in rete si impone per rigore formale e comfort. Lo schienale è valorizzato dal supporto portante posteriore e dall'elemento per la presa superiore dal poggiatesta.

This mesh chair stands out for its formal line and for its comfort. The backrest is enhanced by its supporting element, by its shaped top and by its headrest.

Cette chaise en maille a le charme de la rigueur formelle et au même temps du confort. Le dossier est valorisé par le support porteur postérieur, par l'élément de prise supérieur et par l'appuie-tête.

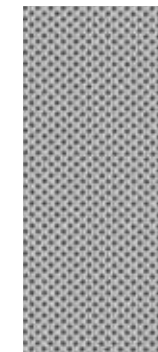

cod. 586



↑
Seduta a slitta con struttura in tubo di acciaio cromato e schienale imbottito.
Cantilever chair with chrome-finished steel tube frame and upholstered backrest.
Chaise à traineau avec structure en tuyau en acier chromé et dossier rembourré.



cod. 593



Ogni particolare esprime funzionalità e comfort: la rete, lo schienale ad altezza variabile, i braccioli regolabili e le meccaniche definiscono l'alto valore della seduta.

Every single detail improves functionality and comfort. Mesh, adjustable backrest height, adjustable armrests and mechanism: all these elements add value to the design of this chair.

Chaque détail exprime fonctionnalité et confort: la maille, le dossier à hauteur variable, les accoudoirs réglables, les mécanismes, définissent la valeur de cette chaise.



sedute operative

operative chairs

sièges de travail







cod. 595

Lo schienale in rete nera garantisce comfort e leggerezza. La poltroncina si smaterializza e assume un'immagine fortemente caratterizzata, tecnica e innovativa.

The black mesh backrest guarantees comfort and lightness. The armchair dematerializes and assumes a strongly characterized, technical and innovative image.

Le dossier en maille noire garantit confort et légèreté. La silhouette du fauteuil s'efface et offre une ligne purée, à la fois technique et innovante.

→ Il bracciolo regolabile in altezza contribuisce alla corretta postura.
The adjustable height of the armrest helps maintaining a correct posture.
L'accoudoir à hauteur réglable facilite une posture correcte.



284



sedute operative



operative chairs



sièges de travail

285





La seduta cantilever è proposta in due versioni di struttura, nera e cromo, che ampliano ulteriormente le possibilità di utilizzo e di abbinamento, rendendola ideale in ogni contesto.

The cantilever seat comes in two frame versions, black and chrome, which further expand the possibilities of use and combination, making it the perfect choice in any context.

L'assise cantilever est disponible en deux modèles de structure, noire et chrome, qui élargissent encore les possibilités d'utilisation et de combinaison, la rendant idéale pour tout type de contexte.



cod. I07







La continuità stilistica è essenziale per garantire un allestimento coerente e completo. Essai in versione cantilever con schienale in rete crea le condizioni del perfetto abbinamento.

Stylistic continuity is essential to ensure a consistent and complete design. Essai in cantilever version with a mesh backrest creates the conditions for the perfect match.

La coordination stylistique est essentielle pour garantir un aménagement homogène et complet. Essai en version cantilever avec dossier en maille crée les conditions de la parfaite combinaison.

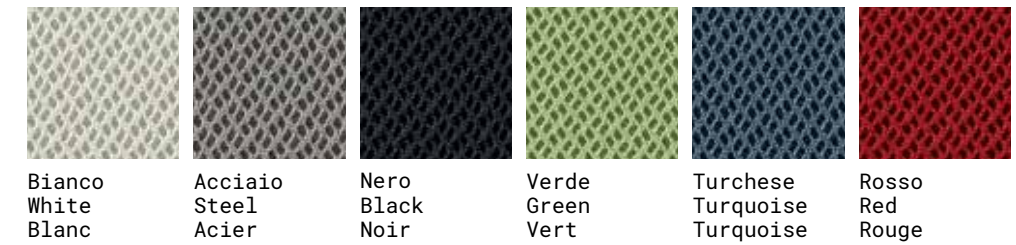

←
L'impiego del poggiatesta modifica completamente le proporzioni della poltroncina rendendola una moderna direzionale.

The use of the headrest completely changes the proportions of the armchair, transforming it into a modern executive chair.

L'utilisation de l'appui-tête modifie complètement les proportions du fauteuil, ce qui en fait un fauteuil de direction moderne.





Gli schienali in colore grigio, antracite e verde si prestano a perfetti abbinamenti con le reti nere, bianche e verdi e con i numerosi tessuti selezionati nel nuovo campionario.

Grey, green and anthracite backrests provide perfect matching with black, white and green mesh and with the wide range of fabrics selected for this new collection.

Les dossiers en gris, vert ou en anthracite, se prêtent à des combinaisons parfaites avec les mailles noires et vertes et les plusieurs tissus sélectionnés pour le nouveau catalogue.

cod. 587

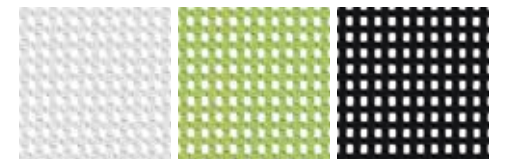

cod. 310 cod. 311 cod. 312

← Lo schienale in rete è proposto in tre varianti cromatiche.
The mesh backrest is available in three colours.
Le dossier en maille è proposé en trois différents couleurs.





cod. 504



←
Slitta con schienale
in plastica in due
colori, con e senza
rivestimento in
tessuto.

Cantilever chair with
plastic backrest in
two colours, with
and without fabric
finishing.

Traineau avec dossier
en plastique en deux
couleurs, sans ou avec
revêtement en tissu.



Oscar

Massimo Costaglia



cod. 745

Lo schienale con scocca in due colori accoglie reti nere e grigie.

The backrest with its two colour frame holds black and grey mesh finishing.

Le dossier avec châssis en deux couleurs reçoit la maille noire ou grise.

cod. 635



cod. 637



cod. 744



La ricca cartella rivestimenti, consente abbinamenti del tutto nuovi fino all'impiego della rete per schienale e seduta imbottita.

The rich palette of finishes allows new combinations which include mesh backrests and upholstered seats.

La grande variété des revêtements permet des combinaisons complètement neuves, comme dans le cas de l'utilisation de la maille pour le dossier et du rembourrage pour l'assise.

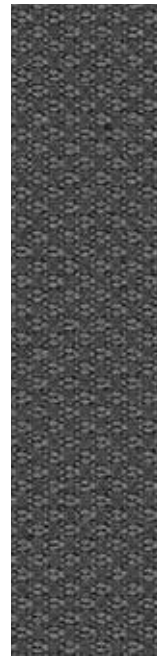

cod. 623



← La seduta su slitta mantiene i caratteri formali della poltroncina.
 The metal base frame version has the formal design of classic office chairs.
 La chaise avec traineau maintient les critères formels d'un fauteuil.



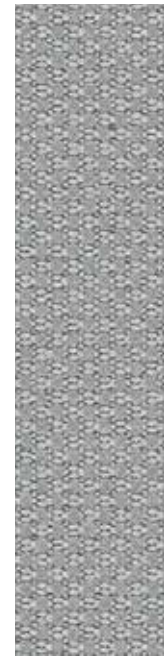

cod. 622



cod. 636



cod. 635



La versione interamente imbottita completa la collezione, potenziando la forza espressiva dei rivestimenti.

The fully upholstered version completes the collection and enhances the expressive power of the finishing.

La version complètement rembourré complète la collection, en augmentant la force expressive des revêtements.

multiuso
for all
polyvalent

FIL ROUGE 5th ELEMENT OXI
UP SCHERMI PIEGO CHIUDO
SEGUO SHARE CUBO PRONTO
CONTENITORI UNIVERSALI
JERA ENOSI E.O.S. IULIO
ELITE DELTA I-MEET NICE POINT
PAUSA CONVIVIO FUNGO
SEGNO ICARO REGOLO KYOTO
PODIO LEAD JERA SCENA NEO
CHAIR TRAMA ATHENA FORMEN
GALASSIA STAR SISTEMA CAST
CIAK PRIMA RASSEGNA ESSAI
HELLÒ OSCAR **F01 F02 F03 F04**
VEDETTE FICTION TROUPE
ZOOM SUPEROTTO PROVINO
F01 BENCH F03 BENCH REGIA
MOVIE TRUKA FESTIVAL JETSET
JERA22 TREND SET22 DOMUS
DRIVE IN DIVO FLAGS TRAILER
WORKLAND

F01



← Due versioni di basamento fisso, con gambe in tubo di acciaio e girevole su ruote.

Two versions for the fixed base with steel-tube legs or swivelling.

Deux versions de base fixe avec pieds en tuyau d'acier et pivotant sur roues.

cod. 636



cod. 693

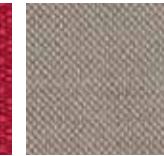

F02



I piccoli elementi di giunzione permettono l'installazione delle sedute in file continue, favorendo un impiego sicuro anche in spazi ad uso collettivo.

The small joining elements allow the installation of the seats in continuous rows, favouring a safe use even in collective spaces.

Les petits éléments de jonction permettent l'installation des sièges en rangées continues, favorisant une utilisation sûre même dans des espaces pour l'usage collectif.

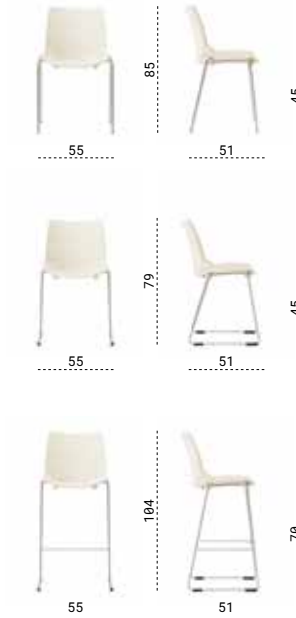

cod. 526



cod. 604



↑
La seduta si arricchisce con il cuscinetto imbottito nei rivestimenti a catalogo.

The seat is embellished by the upholstered cushion with all the finishes included in the catalogue.

La chaise s'enrichit avec le coussin rembourré avec les finitions du catalogue.



F03

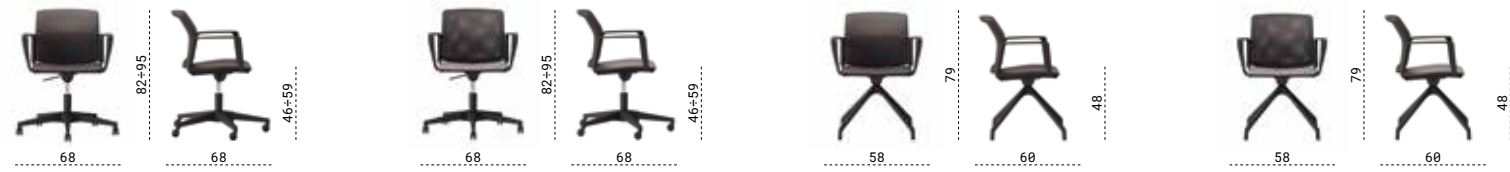

L'ampia dotazione di basi, a quattro gambe con e senza ruote, a slitta e girevoli con ruote, ampliano le possibilità di impiego incrementando le combinazioni estetiche e funzionali.

The wide range of available base models, with four legs, with or without wheels, with frame, swivelling wheels, expands the possible applications and increases aesthetic and functional combinations.

La riche gamme de bases, à quatre pieds, avec ou sans roues, avec des roues coulissantes et pivotantes, permet plusieurs possibilités d'utilisation, en augmentant les combinaisons esthétiques et fonctionnelles.



F04



La comodità della monoscocca si sposa perfettamente con i quattro tipi di basi, ampliando l'impiego della seduta. Il cuscino è l'elemento che introduce il colore, variando ad ogni abbinamento lo stile della sedia e dell'ambiente circostante.

La souplesse de la monocoque s'intègre parfaitement aux quatre types de base, permettant une utilisation variée de l'assise. Le coussin est l'élément qui introduit la couleur, en donnant une touche de style à la chaise et à l'environnement avec chaque combinaison.

The softness of this single-frame model perfectly fits the four types of base, making this chair suitable for a number of applications. The cushion adds colour as well as a stylish touch to the chair and the surrounding environment, thanks to the many possible combinations.

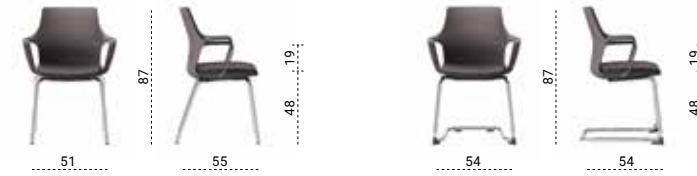

cod. 589



↑
Versione riunione con base a quattro gambe in tubo di acciaio cromato.

Meeting room version with four-leg base in chrome finished steel tube.

Version réunion avec base à quatre pieds en tuyau d'acier chromé.



Vedette

Scagnellato & Ferrarese



I quattro colori delle scocche ampliano le possibilità di abbinamento che variano ulteriormente, inserendo cuscini imbottiti nei rivestimenti a catalogo.

The four colours of the shell allow many combinations, and even more so with the upholstered cushions in all the finishes of the catalogue.

Les quatre couleurs des châssis permettent beaucoup de combinaisons avec les coussins rembourrés et leur revêtements du catalogue, qui donnent variété.

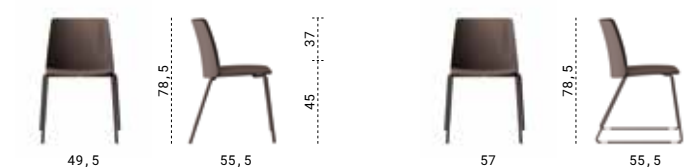

cod. 960

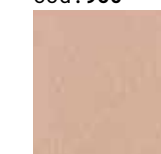

cod. 677

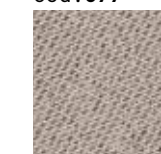

Fiction



Una famiglia completa di sedute destinate a spazi di conferenza e formazione, aperta anche ad aree di attesa e sale riunioni. Una monoscocca in polimero stampato, riccamente accessoriata, in cui il piccolo cuscino imbottito esalta l'estetica e migliora la comodità.

A complete family of seating solutions for conference and training spaces, also suitable for waiting areas and meeting rooms.

A moulded polymer monoshell, richly fitted, in which the small padded cushion enhances the aesthetic appeal and improves comfort.

Une gamme complète de sièges destinés à des espaces de conférence et de formation, également ouverts aux salles d'attente et aux salles de réunion. Une monocoque en polymère imprimé, largement équipée, dans laquelle le petit coussin rembourré rehausse l'esthétique et améliore le confort.



cod. C03



Troupe

Una collezione aperta ad infiniti impieghi: riunioni, visitatore, home office, break. Una multiuso effettiva, comoda e accattivante, che cambia le proprie linee estetiche e le proporzioni grazie alle possibilità di inserimento di basi diverse su ruote, fissa o su slitta.

A collection that lends itself to countless uses: meeting, visitor, home office, break. An effective, comfortable and eye-catching multi-purpose design, versatile in its aesthetic lines and proportions thanks to the possibility of inserting different bases: on wheels, fixed, or cantilever.

Une collection ouverte à des usages infinis: réunions, visiteur, télétravail, détente. Une polyvalence effective, confortable et attrayante, qui change ses lignes esthétiques et ses proportions grâce à la possibilité d'insérer différentes bases sur roulettes, fixes ou traîneaux.



cod. C08



cod. C04

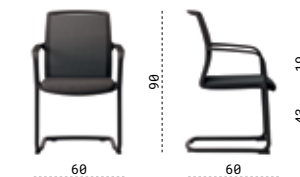

Zoom



cod. I08



Lavorare, connettersi e riunirsi ovunque in modo informale e dinamico, in ufficio o a casa, nella hall di un albergo o nell'area break della propria azienda. Aggregare o disaggregare, unire o separare, fissare o spostare. Contenuti e situazioni diverse che trovano in Zoom un elemento di reale sintesi.

Work, connect and meet anywhere in an informal and dynamic way, in the office or at home, in a hotel lobby or in your company's break area. Group or ungroup, join or separate, attach or move. Different contents and situations that can find a real synthesis in Zoom.

Travailler, se connecter et se réunir partout de manière informelle et dynamique, au bureau ou à la maison, dans le hall d'un hôtel ou dans la zone d'espace détente de votre entreprise. Agréger ou désagréger, fusionner ou séparer, fixer ou déplacer. Différents contenus et situations trouvant dans Zoom une véritable synthèse.



Superotto



Il basamento in versione filo di acciaio cromato e legno crea due importanti alternative estetiche, favorendo abbinamenti diversi. Lo sgabello varia completamente la sua immagine e le proporzioni complessive, rendendolo adatto ad ambienti di lavoro o ad aree per la pausa.

The chrome-finished steel wire and the matching with wood create an impressive effect and allow interesting combinations. This stool changes its image and overall proportions and becomes perfect for work or break areas.

La base en version en fil d'acier chromé et bois crée deux importantes alternatives esthétiques et favorisent des différentes combinaisons. Le tabouret change complètement son image et ses proportions, ce qui le rend idéal pour les aires de travail ou pour prendre une pause.



cod. 738

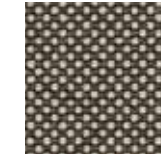

Provino

Scagnellato & Ferrarese



Elevazione, rotazione e oscillazione sono i movimenti della seduta che ne consentono un impiego sempre diverso all'interno di innovativi smart offices.

L'élevation, la rotation et l'oscillation sont les mouvements du siège qui permettent une utilisation en constante évolution dans les bureaux innovants.

Elevation, rotation and oscillation are the movements of the seat that allow for an ever-changing use within innovative smart offices.

cod. 958



attesa & riunione
waiting & meeting
attente & réunion

FIL ROUGE 5th ELEMENT OXI
UP SCHERMI PIEGO CHIUDO
SEGUO SHARE CUBO PRONTO
CONTENITORI UNIVERSALI
JERA ENOSI E.O.S. IULIO
ELITE DELTA I-MEET NICE POINT
PAUSA CONVIVIO FUNGO
SEGNO ICARO REGOLO KYOTO
PODIO LEAD JERA SCENA NEO
CHAIR TRAMA ATHENA FORMEN
GALASSIA STAR SISTEMA CAST
CIAK PRIMA RASSEGNA ESSAI
HELLÒ OSCAR F01 F02 F03 F04
VEDETTE FICTION TROUPE
ZOOM SUPEROTTO PROVINO
F01 BENCH F03 BENCH REGIA
MOVIE TRUKA FESTIVAL JETSET
JERA22 TREND SET22 DOMUS
DRIVE IN DIVO FLAGS TRAILER
WORKLAND

F01 Bench

Le sedute su barra
permettono di ottimizzare
lo spazio offrendo la
possibilità di allestire sale
d'attesa confortevoli e
accoglienti.

Les chaises sur barre
permettent d'optimiser
l'espace tout en donnant la
possibilité de créer des salles
d'attentes confortables et
accueillantes.



Bar-mounted seats optimise
space and create comfortable
and welcoming waiting areas.

cod. 611



328

attesa & riunione

waiting & meeting



attente & réunion

329

F03 Bench

La collezione persegue l'obiettivo di aumentare il numero dei posti a sedere e nel contempo di migliorare la comodità degli ospiti in attesa.

This collection aims at increasing the number of seats while improving the guests' comfort.

La collection a pour but d'augmenter le nombre des places et au même temps d'améliorer le confort des visiteurs en attente.



cod. 912



Regia

CSR Las Mobili

Le tre basi, in legno, in filo di acciaio e in alluminio a 4 razze, consentono alla poltroncina di rispondere ad esigenze estetiche e differenti destinazioni d'uso.

The three base options wood, steel wire and 4 spokes aluminium base, make this chair ideal to meet different aesthetic needs and functions.

Les trois bases, en bois, en fil d'acier et en aluminium à 4 rayons, permettent à cette chaise de répondre à besoins esthétiques et utilisations différentes.



cod. 652



cod. 649

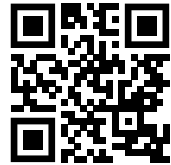

Movie

CSR Las Mobili

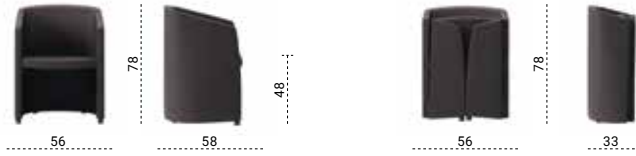

Le linee essenziali unite alla selezione di rivestimenti a catalogo fanno di Movie una perfetta collezione di imbottiti per la riunione.

These essential lines matched with the selection of available finishes turn Movie into a perfect collection of upholstered seats for meeting rooms.

Les lignes essentielles revêtues avec les finitions du catalogue font de Movie une collection parfaite d'éléments rembourrés pour les salles de réunion.



cod. 780

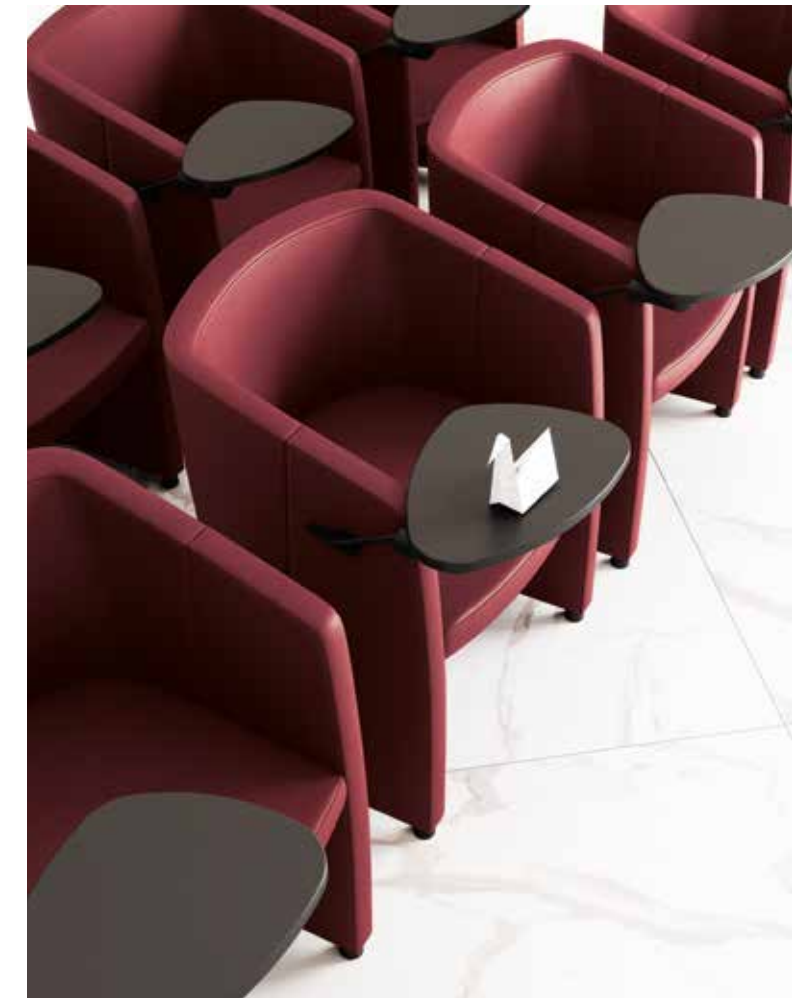

FIL ROUGE 5th ELEMENT OXI
UP SCHERMI PIEGO CHIUDO
SEGUO SHARE CUBO PRONTO
CONTENITORI UNIVERSALI
JERA ENOSI E.O.S. IULIO
ELITE DELTA I-MEET NICE POINT
PAUSA CONVIVIO FUNGO
SEGNO ICARO REGOLO KYOTO
PODIO LEAD JERA SCENA NEO
CHAIR TRAMA ATHENA FORMEN
GALASSIA STAR SISTEMA CAST
CIAK PRIMA RASSEGNA ESSAI
HELLÒ OSCAR F01 F02 F03 F04
VEDETTE FICTION TROUPE
ZOOM SUPEROTTO PROVINO
F01 BENCH F03 BENCH REGIA
MOVIE **TRUKA FESTIVAL JETSET**
JERA22 TREND SET22 DOMUS
DRIVE IN DIVO FLAGS TRAILER
WORKLAND

La collezione presenta due versioni di sedute: Lounge e poltroncina, entrambe offerte con due basi opzionali alternative, in alluminio e in legno e con le tante possibilità dei rivestimenti Las in tessuto, pelle e ecopelle.

The collection has two ranges of seating options: lounge and armchair, both available with two optional alternative bases in aluminium or wood along with the many possibilities of Las upholstery in fabric, leather and faux leather.

La collezione présente deux versions d'assises: Salon et petit fauteuil, tous deux proposés avec deux bases alternatives en option, en aluminium et en bois et avec les nombreuses possibilités des revêtements Las en tissu, cuir et faux cuir.

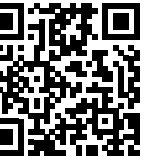

Festival

Orlandini Design - CSR Las Mobili



Il bracciolo, piatto all'esterno e convesso all'interno, determina un felice punto di incontro tra tratto stilistico e perizia manifatturiera, rendendo la collezione classica e moderna insieme.

The armrest, flat on the outside and convex on the inside, provides a happy meeting point between style and craftsmanship, resulting in a classic and modern collection.

L'accoudoir, plat à l'extérieur et convexe à l'intérieur, détermine un heureux point de rencontre entre trait stylistique et expertise manufacturière, rendant la collection à la fois classique et moderne.



cod. C06

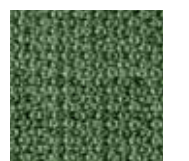

cod. C05



Jetset

Orlandini Design - CSR Las Mobili

Leggerezza e forza espressiva sono le parole d'ordine di una collezione di poltrone e divani per l'attesa o la riunione informale in cui le gambe alte e snelle esaltano il taglio diagonale del bracciolo.

Légèreté et force expressive sont les mots d'ordre d'une collection de fauteuils et canapés destinés aux salles d'attente ou de réunion informelle dans laquelle des pieds hauts et fins mettent en valeur la coupe diagonale de l'accoudoir.

Lightness and expressive force are the watchwords for a collection of armchairs and sofas for waiting areas or informal meetings in which tall, slender legs enhance the diagonal cut of the armrest.



cod. C04

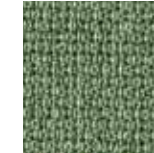

cod. E04



Jera 22

Orlandini Design - CSR Las Mobili

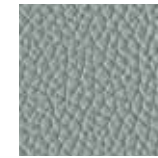

cod. 774



cod. I32

**Il piedino verniciato
alleggerisce gli appoggi,
mantenendo alto il livello
di eleganza del modello.
Attenzione e cura fino ai più
piccoli dettagli.**

Painted feet to lighten
the frame, confirming the
impressive elegance of this
model. Great attention and
care to the smallest details.

Le pied peint donne légèreté
aux appuis et garantit
le niveau d'élégance du
modèle. Attention et soin
dans les moindres détails.



Trend

CSR Las Mobili



cod. 609



cod. 607



Le ampie superfici sono interrotte dalle cuciture lineari poste su seduta e schienale. Segni e linee che determinano lo stile inconfondibile di Trend.

Large surfaces, outlined and interrupted by linear seams on the seat and backrest. Marks and lines that characterise the unmistakable style of the Trend collection.

Les grandes surfaces sont interrompues par les coutures linéaires sur l'assise et sur le dossier. Signes et lignes qui déterminent le style unique de Trend.

Set 22

Orlandini Design - CSR Las Mobili

Le linee e le proporzioni complessive trasmettono un grande rigore formale e una sobria eleganza che favoriscono l'inserimento di Set 22 in ambientazioni diverse per stile e funzionalità.

The lines and overall proportions convey a great formal rigour and understated elegance that favour the inclusion of Set 22 in a variety of different environments in terms of style and functionality.

Les lignes et les proportions globales transmettent une grande rigueur formelle et une élégance sobre qui favorisent l'inserimento de Set 22 dans des environnements différents en termes de style et de fonctionnalité.

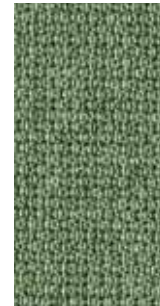

cod. C04



Domus

CSR Las Mobili



L'impiego di pelle o tessuto è sempre appropriato in Domus. Le forme geometriche esaltano ogni rivestimento, dal più compatto al più morbido.

Both leather and fabric are used here to confirm Domus' elegance. Geometric shapes that highlight all finishings, from the most compact to the softest.

L'utilisation de cuir ou de tissu est toujours appropriée sur Domus. Les formes géométriques mettent en évidence tout type de revêtement, du plus compact au plus souple.



cod. 776

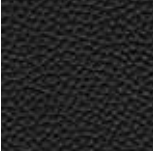

cod. 643



cod. 642

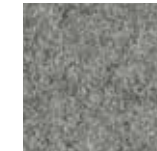

cod. 645



Drive In

Orlandini Design - CSR Las Mobili

Infinite combinazioni di colori e di tessuti da selezionare e abbinare fino a coinvolgere completamente vista e tatto. Drive In si pone come collezione dai forti contenuti sensoriali e comunicativi.

An endless selection of combinations of colours and fabrics that can be matched to fully involve sight and touch.

In is a collection with strong sensory and communicative content.

Des combinaisons infinies de couleurs et de tissus à sélectionner et à assortir jusqu'à impliquer complètement la vue et le toucher. Drive In se présente comme une collection à fort contenu sensoriel et communicatif.



FIL ROUGE 5th ELEMENT OXI
UP SCHERMI PIEGO CHIUDO
SEGUO SHARE CUBO PRONTO
CONTENITORI UNIVERSALI
JERA ENOSI E.O.S. IULIO
ELITE DELTA I-MEET NICE POINT
PAUSA CONVIVIO FUNGO
SEGNO ICARO REGOLO KYOTO
PODIO LEAD JERA SCENA NEO
CHAIR TRAMA ATHENA FORMEN
GALASSIA STAR SISTEMA CAST
CIAK PRIMA RASSEGNA ESSAI
HELLÒ OSCAR F01 F02 F03 F04
VEDETTE FICTION TROUPE
ZOOM SUPEROTTO PROVINO
F01 BENCH F03 BENCH REGIA
MOVIE TRUKA FESTIVAL JETSET
JERA22 TREND SET22 DOMUS
DRIVE IN **DIVO FLAGS TRAILER**
WORKLAND

Piccoli piani accessori, autoportanti e facilmente riposizionabili, completano la collezione rendendola adeguata alle esigenze funzionali del lavoro agile.

Des petits plateaux accessoires, autoportants et facilement re-configurables, complètent la collection et la rendent fonctionnel au travail agile.



Small ancillary worktops, self-supporting and easily movable, complete this collection to meet the functional needs of agile work.





cod. I06



↑
Composizione per riunioni informali riservate con schienali alti.
Informal and private meeting composition with high backrests.
Composition pour réunions informelles avec dossiers hauts.



La modularità degli schienali consente di variare l'altezza, differenziando assorbimento acustico e di riservatezza.

The modularity of backrests allows to change their height, to meet different needs for sound absorption and privacy.

La modularité des dossiers permet de varier la hauteur, et au même temps d'obtenir différents niveaux d'absorption acoustique et d'intimité.

cod. 681

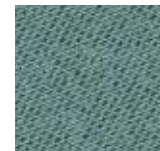

cod. 684



Flags

Orlandini Design

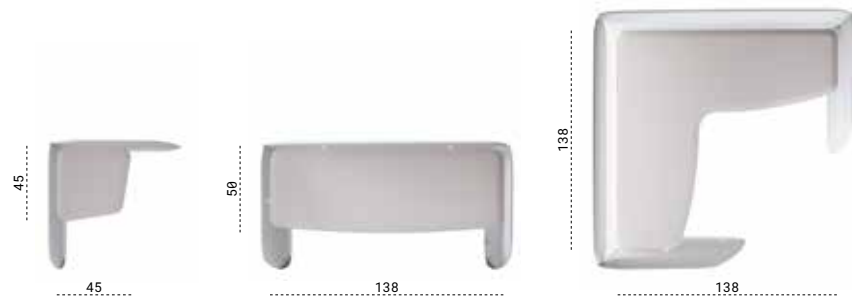

Le postazioni di lavoro tradizionali diventano angoli riservati dal notevole comfort acustico.

Traditional work stations turn into private corners with very remarkable sound absorption.

Les postes de travail traditionnelles deviennent des coins privés à haut confort acoustique.



cod. 645

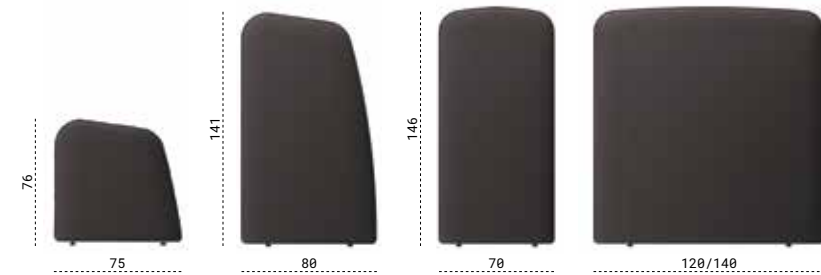



← Composizioni per la lettura o la conversazione telefonica riservata.
Ideal combinations for reading or for private phone conversations.
Composizioni pour la lecture ou les entretiens téléphoniques confidentiels.

cod. 696



cod. 689

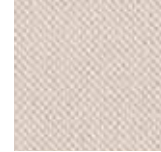

Poltrone e divani monocromatici o bicolore su cui, grazie ai tavoli satellite, comodità ed operatività convivono perfettamente.

Monochromatic or two-coloured armchairs and sofas on which, thanks to the satellite tables, comfort and functionality coexist perfectly.

Fauteuils et sofas monochromatiques ou en bi-couleur avec tables satellite pour une convivialité parfaite.



cod. 609



Trailer

SI DESIGN

Studiato per ambienti attesa, lounge, ospitalità, lavoro e spazi multifunzionali, Trailer si caratterizza per le sue linee fluide, sinuose e geometriche.

Designed for waiting areas, lounges, hospitality, work and multifunctional spaces, Trailer is characterised by its fluid, sinuous and geometric lines.

Étudié pour des espaces attente, salon, accueil, travail et espaces multifonctionnels, Trailer se caractérise par ses lignes fluides, sinueuses et géométriques.



cod. C08



cod. C07

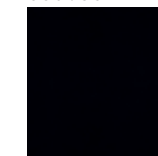

cod. Nr 03





Workland, grazie alle diverse soluzioni dimensionali e stilistiche incentiva la qualità e sostenibilità dell'ufficio dotando quest'ultimo di forte originalità interpretativa secondo i più avanzati concetti di smart office.

Thanks to its different dimensional and stylistic solutions, Workland promotes the quality and sustainability of the office, imbuing the workplace with strong interpretative originality in accordance with the most advanced smart office concepts.

Grâce aux différentes solutions dimensionnelles et stylistiques Workland stimule la qualité et la durabilité du bureau en le dotant d'une fonctionnalité multiple associée à la forte originalité entendue comme vaste interprétation du vrai bureau intelligent moderne.



cod. 41



cod. 40

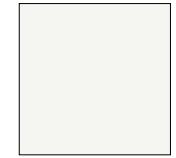

cod. Bi 02



cod. Vr 02



cod. E09



cod. E10



finiture
finishes
finitions

Inquadra il QrCode e scopri le finiture disponibili

Scan the QrCode and discover the available finishes

Scannez le QR Code e découvrez les finitions disponibles

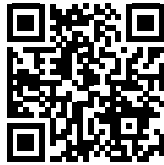

Category	A	B	C	D	D	E	E	E	E	F	G	G	I	I	I	H	R1	R2	R3	R4	T1	T2	T3	T4	T5	T6	T7	T8
Direzionali Executive chairs Fauteuils de direction																												
Lead																												
Jera																												
Scena																												
Neo Chair																												
Trama																												
Athena																												
Formen																												
Galassia																												
Operative Operative chairs Sieges de travail																												
Star																												
Sistema																												
Cast																												
Ciak																												
Prima																												
Rassegna																												
Essai																												
Hellò																												
Oscar																												
Multiuso Forall Polyvalent																												
F01																												
F02																												
F03																												
F04																												
Regia																												
Vedette																												
Superotto																												
Troupe																												
Fiction																												
Zoom																												
Provino																												
Attesa e riunione Waiting and meeting Attente et reunion																												
Panca Benches Bancs F01																												
Panca Benches Bancs F03																												
Movie																												
Lounge																												
Truka																												
Festival																												
Jetset																												
Jera 22																												
Trend																												
Set 22																												
Domus																												
Drive In																												
Cuscini cushions coussins																												
Smart office																												
Divo																												
Flags (panels)																												
Flags (sofa)																												
Trailer																												
Workland																												

Rendering_

Matic®

Photolito_

Selecolor Firenze Srl

ED_

02.2024

LAS®

Las Mobili s.r.l

Via dell'Industria, n 81
64018 Tortoreto (TE) - Italy

T. +39. 0861 7831

F. +39. 0861 786851

las@las.it - www.las.it

COD. 100001135

